

Sustainability Comparison Study:
Assessing Centralized Treatment
Upgrades and POU/POE Treatment for
Small System Compliance to the SDWA

Final Report
April 29th, 2022

Dr. Emily Kumpel
Dr. Kaycie Lane
Dr. David Reckhow
Dr. John Tobiason

Table of Contents

List of Abbreviations	iv
List of Tables	v
List of Figures	vi
Executive Summary	1
1 - Introduction	4
2 – Selection of Case Studies and Technology Alternatives.....	9
2.1 Methods.....	9
2.1.1 Community Water System Selection	9
2.1.2 Selection of Alternatives for Comparison.....	11
2.1.3 Data collection for selected treatment alternatives.....	13
2.2 Selection process results.....	14
2.2.1 Selected Communities	14
2.2.2 Selected technology alternatives	17
2.2.2.1 Centralized treatment improvements	17
2.2.2.3 <i>Initial data collection results and water treatment system improvement diagrams</i>	22
3 – Exposure Assessment.....	25
3.1 Methods	25
3.1.1 Estimating contaminant exposure.....	25
3.1.2 Estimating time to implement by modeling exposure duration.....	35
3.2 Results	37
3.2.1.1 Estimating intake of contaminants	37
3.2.2 Estimating time to implement by modeling exposure duration.....	44
3.2.3 Lifetime exposure	53
4 – Life Cycle Analysis (LCA)	65
4.1 Methods.....	65
4.1.1 Functional Unit	67
4.1.2 Software and Databases	67
4.1.3 System boundaries and data collection.....	67
4.1.3 Inventory generation	69
4.1.4 Impact Assessment	72
4.1.5 Data Interpretation.....	72
4.2 Results	72
4.2.1 Inventory generation	72

4.2.2 Impact Assessment	76
5 – Life Cycle Costing (LCC)	87
5.1 Methods	87
5.1.1 EPA Cost Models	87
5.1.2 Data inputs	89
5.1.3 Modeling best and worst-case cost	90
5.2 Results	91
5.2.1 Cost Assumptions	91
5.2.2 Cost Results	96
5.2.3 Cost comparisons between centralized and POU/POE	104
5.2.3 Cost Sensitivity Results	108
5.2.4 Best- and Worst-Case Cost Scenarios	116
5.2.5 Summary of cost analysis results	120
6 – Triple Bottom Line Approach Summary	121
6.1 CWS and Device Selection	121
6.2 Triple Bottom Line Approach results	121
6.2.1 Region 1	123
6.2.2 Region 5	123
6.2.3 Region 7	124
6.2.4 Region 9	125
7 – Considerations and Recommendations for POU/POE devices as a SDWA compliance strategy	126
7.1 Systemic and Policy-Level Barriers	126
7.2 Technical Barriers	128
7.3 Model Assumptions specific to CWSs	129
7.4 Recommendations	130
References	133
Appendix A: Selected technology process flow diagrams	137
Appendix B: POU and POE Device Listings	140
Appendix C: Exposure Assessment	143
Appendix D: Life Cycle Assessment	174
Appendix E: Life Cycle Cost	179

List of Abbreviations

ADD	Average daily dose
AM	Adsorptive media
ANSI	American National Standards Institute
CDI	Chronic daily intake
CSA	Canadian Standards Association
CWS	Community water system*
DWUR	Drinking water unit risk
GAC	Granular activated carbon
GFH	Granular ferric hydroxide
HQ	Hazard quotient
IAPMO	International Association of Plumbing and Mechanical Officials
IRIS	Integrated Risk Information System
IX	Ion exchange
LCA	Life cycle analysis
LCC	Life cycle costing
LOAEL	Lowest observable adverse effect level
MCL	Maximum contaminant level
MLE	Maximum likelihood estimate
NOAEL	No observable adverse effect level
NSF	NSF International
PFAS	Perfluoroalkyl substances
PID	Performance indicator device
POE	Point-of-entry
POU	Point-of-use
RO	Reverse osmosis
SDWA	Safe Drinking Water Act
SDWIS	Safe Drinking Water Information System
TCR	Total carcinogenic risk
USEPA	United States Environmental Protection Agency
WBS	Work-based structure
WQA	Water Quality Association

*Note: in this report, CWS and “Community” are used interchangeably to refer to community water systems

List of Tables

Table 1: Summary of cost comparison studies.....	6
Table 2.1: Number of eligible CWSs by region and contaminant	11
Table 2.2: Selected community water systems (CWSs) for study.....	15
Table 2.3: Selected water treatment system improvements for each community	22
Figure 2.4: Components of the centralized treatment improvement for Region 1.....	23
Table 3.1: Assumptions for CDI calculation (USEPA, 1992).	29
Table 3.2: Contaminant removal rates for selected alternatives (USEPA, n.d., USEPA, 1978, USEPA, 2003a, USEPA, 2003b, USEPA, 2006a)	30
Table 3.3: Selected centralized and POU/POE alternative removal rates and best-case and worst-case scenarios based on removal rates from literature used to model exposure in each CWS	32
Table 3.4: Reference literature values for each contaminant considered in the oral exposure route (USEPA IRIS, 1989, USEPA IRIS, 1991, USEPA IRIS, 2021b).....	34
Table 3.5: Oral chronic daily intake exposure from arsenic in Region 1.....	39
Table 3.6: Overall initial results indicating where carcinogenic risk is expected	41
Table 3.7: Probabilistic chronic daily intake results for Region 1 exposure showing percentiles of interest related to exposure	44
Table 3.8: Region 1 ADD values for POU AM technologies (Device B) and centralized improvements	46
Table 3.9: Summary of the of the time to implement alternatives for different removal efficiencies	48
Table 3.10: Summary of time to implement for each alternative.	51
Table 3.11: Region 1 lifetime exposure results over 30 years compared to an exposure to the NOAEL level of arsenic.	53
Table 3.12: Region 5 lifetime exposure results over 30 years compared to an exposure to the NOAEL level of arsenic.	56
Table 3.13: Region 7 lifetime exposure results over 30 years compared to an exposure to the NOAEL level of arsenic.	58
Table 3.14: Region 9 lifetime exposure results over 30 years compared to an exposure to the NOAEL level of arsenic.	60
Table 3.15: Summary of lifetime exposure modeling.....	62
Table 3.16: Rankings for each option in all regions based on the lifetime exposure assessment results.....	64
Table 4.1: A cost model and set of model assumptions were selected for each CWS to generate an inventory of components for each centralized treatment upgrade (USEPA, 2017b, USEPA, 2021c).	70
Table 4.2: Distances used to calculate transportation impacts in each CWS.	71
Table 4.3: Example inventory for centralized anion exchange with a nitrate selective resin in Region 7.....	73
Table 4.4: POU device information.....	74
Table 4.5: Inventory of material for two POU RO devices.....	75
Table 4.6: Summary and ranking of the LCA impact assessment results in each CWS.....	86
Table 5.1: Values extracted from EPA cost models	89
Table 5.2: Assumptions used to model cost using the EPA POU/POE Cost Model.	92
Table 5.3: Summary of primary costs per household over 30 years in Region 1.....	97
Table 5.4: Summary of primary costs per household over 30 years in Region 5.....	99
Table 5.5: Summary of primary costs per household over 30 years in Region 7.....	101
Table 5.6: Summary of primary costs per household over 30 years in Region 9.....	103
Table 5.7: Cost comparison by category of cost for each CWS over 30 years per household.....	105
Table 5.8: Assumptions for best-case and worst-case cost modeling.....	116
Table 5.8: Summary of best cost options for each CWS.	120
Table 6.1: Summary of the triple bottom line results for each CWS	122

List of Figures

Figure 2.1: Methodology for finding and selecting CWSs for participation in this study	10
Figure 2.2: Criteria used to select 2 POU/POE devices for each CWS.	13
Figure 2.3: Methodology to select POE and POU devices	20
Figure 2.5: Components of a POU RO device selected for Region 1.....	24
Figure 3.1: Estimated probabilistic chronic daily intake scenarios.	28
Figure 3.2: Method describing use of ADD over 30 years to determine the time to implement an alternative based on removal rate and exposure duration.....	36
Figure 3.3: Timeline of installation estimates for alternatives including the time at which the ADD values exceed the NOAEL values for a given removal efficiency in Region 1.....	50
Figure 3.4: Summary of the number of years before the HQ>1 compared to the worst-case implementation timeline as identified by CWS stakeholders.	52
Figure 3.5: Lifetime exposure results for Region 1 based on specific CWS timelines for implementation.	55
Figure 3.6: Lifetime exposure results for Region 5 based on specific CWS timelines for implementation.	57
Figure 3.7: Lifetime exposure results for Region 7 based on specific CWS timelines for implementation.	59
Figure 3.8: Lifetime exposure results for Region 9 based on specific CWS timelines for implementation.	61
Figure 4.1: LCA methodology components adapted from the ISO, 14040 standard (ISO, 2006).	66
Figure 4.2: Components included within the system boundaries for Region 1’s LCA are shown in color while pre-existing components are shown in grey.	68
Figure 4.3: LCA Impact assessment results for Region 1.	78
Figure 4.4: LCA Impact assessment results for Region 5.	80
Figure 4.5: LCA Impact assessment results for Region 7	82
Figure 4.6: LCA Impact assessment results for Region 9.	84
Figure 4.7: Comparison of LCA impact assessments across all four case studies.....	86
Figure 5.2: Total cost over 30 years normalized per household for each set of assumptions	96
Figure 5.3: Total cost per household over 30 years for each alternative in Region 1 with a breakdown to show the cost elements.	98
Figure 5.4: Total cost per household over 30 years for each alternative in Region 5 with a breakdown to show the cost elements.	100
Figure 5.5: Total cost per household over 30 years for each alternative in Region 7 with a breakdown to show the cost elements.	102
Figure 5.6: Total cost per household over 30 years for each alternative in Region 9 with a breakdown to show the cost elements.	104
Figure 5.3 shows the cost elements that constitute the total cost of each alternative in each water system.	106
Figure 5.3: Total cost over 30 years for each alternative in each community water system.	106
Figure 5.8: Cost sensitivity analysis results for centralized treatment in Region 1	109
Figure 5.9: Cost sensitivity results for the POU AM device in Region 1.....	110
Figure 5.10: Cost sensitivity analysis for the POU RO Device in Region 1.	111
Figure 5.11: Full comparison of cost sensitivity analysis for Region 1.....	112
Figure 5.12: Summary of the cost sensitivity results from Region 5.	113
Figure 5.13: Summary of the cost sensitivity results from Region 7.	114
Figure 5.14: Summary of the cost sensitivity results from Region 9.	115
Figure 5.15: Summary of best-case and worst-case cost sensitivity results in all four CWSs.....	119

Executive Summary

This study examined point-of-use (POU) and point-of-entry (POE) devices in comparison to improvements to existing centralized systems for Safe Drinking Water Act compliance using a triple bottom line analysis. The study was conducted using data from four very small community water systems (serving less than 500 people) from four different USEPA regions in the United States to ground the analysis in the community specific considerations necessary to complete a triple bottom line analysis. An exposure assessment was conducted to evaluate human health impacts of each alternative (POU/POE versus centralized treatment), a life cycle analysis to examine environmental impacts and a life cycle costing analysis to examine economic impacts over a thirty-year study period. The analysis was specifically targeted to examine the considerations necessary to implement POU/POE devices as a compliance solution for either arsenic or nitrate contamination for community water systems. The purpose of the study was to holistically examine the tradeoffs a very small water system may face when choosing an additional treatment solution to remove a specific drinking water contaminant of concern.

The triple bottom line analysis conducted in this study was informed by state-specific and community-specific assumptions in order to ensure the analysis was as complete and realistic as possible. As such, the assumptions we documented for each state are presented in the full report to frame the analysis results in detail. In each community water system, we consulted with state administrators, community water system operators and other important water system stakeholders to understand the existing water treatment system and to identify a realistic improvement that the community was interested in exploring. We then identified two POU/POE devices for each community water system that are certified to the relevant NSF/ANSI standards for the removal of either arsenic or nitrate specifically. We consulted state specific guidance on POU/POE devices to determine (1) whether to select a POU or POE solutions and (2) how the state approves and implements POU/POE devices to determine the necessary steps to implement a POU/POE device as a compliance strategy.

Human Health Exposure

Exposure assessment was used to examine the health impacts associated with the implementation of a technology. Exposure assessment results revealed the importance of the relationship between the removal efficiency of a treatment solution and the number of years until a solution could feasibly be expected to be implemented in a community water system. While the installation time of POU/POE devices is expected to be quicker than a centralized improvement in many cases, the planning time (including state approvals, device selection, etc.) is expected to contribute a significant amount to how rapidly POU/POE devices can be implemented as a compliance solution.

Even though POU/POE device removal efficiencies tend to be higher than centralized technologies, the requirement for 100% participation prior to implementation extends the implementation timeline such that the benefits of removal efficiencies tend to be minimized. Our results show that in systems with

high concentrations of contaminants such as arsenic and nitrate, it is critical to implement a technology in a timely manner to reduce lifetime exposure in the most vulnerable populations.

Environmental Sustainability

The life cycle analysis (LCA) performed in this study utilized the SimaPro software (version 8.2.1), the ecoinvent inventory database, the TRACI 2.0 method for impact assessment and a functional unit of the water consumer in one household. LCA results indicate that POU/POE devices contribute less per kilogram of material to environmental impacts than improvements to centralized systems in general as a result of a smaller amount of material used in 30 years. Where POU units were compared to adsorptive media and ion exchange centralized technologies, we observed that the cost to process, transport and dispose of these medias contributed the most to the overall impact of these solutions. Similarly, the POE adsorptive media devices examined in Region 5 specifically had larger impacts than the relatively small centralized improvement of optimizing pre-oxidation because of the high impact of the adsorptive media. In Region 1, 7 and 9, POU devices proved to have the lowest overall impacts, with POU RO Device D having the lowest total environmental impact overall.

Economic Cost

The life cycle cost (LCC) analysis utilized the replacement frequencies from manufacturers, the EPA Cost Models and state specific assumptions to create a detailed inventory of the costs associated with each technological alternative. We extracted unit costs and useful life from the EPA cost models for the centralized cost alternatives and informed these same cost components through conversations with manufacturers and state stakeholders for the POU/POE devices.

Our results indicate that POU devices were a viable alternative from an economic perspective in Region 1, which is the smallest size community with 24 connections and a state-enabling environment that removes many of the barriers to POU/POE implementation. The replacement frequency of POU/POE components in each household coupled with the regulatory sampling requirements for POU/POE compliance generate large O&M costs for these devices which exceeded the cost of the centralized's upgrade O&M in Regions 5,7, and 9 over the 30 year study period.

Considerations for POU/POE as a compliance strategy

Through our analysis, we identified several critical factors that influence whether a POU/POE device may be used as a compliance solution in very small community water systems. We separated these factors into three categories: systemic barriers to timely and effective POU/POE implementation, technical barriers to long-term sustainability and viability of POU/POE devices and model specific assumptions that need to be considered when applying the triple bottom line analysis to other community water systems. Systemic barriers included whether a state allowed POU or POE devices for compliance purposes, the requirement of 100% community participation prior to piloting and implementation, difficulties identifying certified POU/POE options suitable to a specific community and SDWA sampling compliance requirements. Technical barriers included the high replacement frequency

of POU/POE components over the 30-year study period, the number of households where POU/POE units needed to be installed and maintained, and the piloting requirements specific to state guidance on POU/POE devices. Finally, assumptions that need to be changed based on the specific community water system include disposal options for specific technology types and contaminants of concern, long-term sampling frequencies for compliance, the number of O&M activities (labor and frequency of maintenance) and the source water characteristics of the community water supply.

Based on the three different factors above, we present recommendations both to state compliance agencies and POU/POE device manufacturers to aid in the implementation and viability of POU/POE devices in very small water systems. Through conversations with state administrators and POU/POE manufacturers, we learned there are barriers to implementing and installing POU/POE devices in a reasonable timeframe that can be removed with greater communication between these two groups of stakeholders. We present recommendations to aid community water systems to readily find information about POU/POE devices, to aid state administrators in obtaining information about device performance and to aid manufacturers in communicating performance of POU/POE devices.

1 - Introduction

Small community water systems (CWS) are faced with many challenges in delivering water that meets regulatory standards (Allaire et al., 2018; Oxenford and Barrett, 2016). The USEPA defines small water systems as those that serve at least 25 people (or at least 15 service connections) but fewer than 10,000 people (USEPA,2017a). While previous research has found that small systems are no more likely to violate health related requirements as compared to large systems, these results are likely confounded by lack of adequate monitoring and reporting among smaller systems (Allaire et al., 2018; Rubin, 2013). Safe Drinking Water Act (SDWA) health-based violations are issued to small water systems that have maximum contaminant levels (MCLs) exceedances, do not meet required treatment techniques, or exceed the maximum residual disinfectant levels. In the recent study by Allaire et al (2018), 9% of all CWS in the United States experienced a health-based violation in 2015, including total coliform, surface water treatment rule (SWTR) or groundwater rule (GWR), nitrate, arsenic, lead and copper, disinfection byproducts, and radionuclides. These exceedances may result from unprotected or contaminated source waters, inadequate or poorly maintained treatment systems, and/or conditions within distribution systems. Small systems are often constrained by limited financial, technical, and personnel resources, which may lead to their inability to address any of these issues (Oxenford and Barrett, 2016).

For small and, particularly, very small systems (serving fewer than 500 people), there may be a point at which installing point-of use or point-of-entry (POU/POE) devices at individual households or buildings are a feasible option that provides equal benefits at less economic, human, and/or environment costs compared to investments in the centralized water system that would be needed for the CWS to be compliant with the Safe Drinking Water Act (SDWA). This triple bottom line approach involves the analysis of three key impacts: human health impacts (People), environmental impacts (Planet) and economic impacts (Profit). While estimations of each of these three costs for individual POU/POE systems or centralized water systems have been conducted individually, to our knowledge, no study has addressed and compared their tradeoffs in economic, human, and environmental costs. Furthermore, previous cost estimates have been system-specific and focused on determining the feasibility of alternatives for a given water system rather than developing a framework for decision-making. Community water systems often need to weigh the human, environmental, and economic costs prior to choosing an alternative form of treatment; a holistic model that provides a water system with this information is currently missing when examining the tradeoffs between centralized treatment upgrades and POU/POE devices.

The objective of this study was to use a triple bottom line approach to examine improvements to water treatment systems. We specifically examine and compare installing POU/POE systems in individual households to adjusting the centralized water treatment system to meet SDWA standards for an existing small CWS. We gathered case study data from four CWS, each in different regions of the US, to assess human health exposure due to time to implement (human exposure to a contaminant in drinking water), the environmental sustainability using a life cycle assessment (environmental cost),

and the life cycle costs (economic costs) to install and maintain each type of treatment improvement. In addition to the rich case study approach we take in this analysis, we use these four CWS systems to develop generalizable frameworks for collecting data and comparing options for meeting regulatory compliance, including examining which parameters need to be system specific. We present the results from each individual case study as well as recommendations, generalizable methods, and adaptations for application to future water system analysis.

This study examines improvements to water treatment systems in *existing* CWS that are not currently in compliance with (or are close to noncompliance with) SDWA regulations for a *single* chemical contaminant. The boundaries of our analysis are drawn around the specific improvement needed to bring an existing CWS system into compliance for one specific contaminant. Our analysis is notably different than other studies which compare whether to install POU/POEs in self-supply households as opposed to creation of a new CWS where one does not exist. Additionally, we focus on only the treatment upgrade needed to bring a system into compliance for a single contaminant; while treatment is designed to treat a suite of contaminants, we assume the existing treatment at the CWS stays intact to treat the other contaminants (including to meet Total Coliform Rule compliance, for which POU/POEs cannot be used for SDWA compliance). To that end, we present process flow diagrams of each centralized improvement and POU/POE device to delineate the system boundaries defined for each CWS. We have used this detailed process to explicitly identify the components of each improvement (centralized or POU/POE) to demonstrate how these are additions to an existing system as opposed to standalone technological solutions. The intention is to provide information to inform CWS deciding between improvements to water treatment systems based on information about cost, sustainability and protection of human health; small systems often have to balance these three factors when making changes to an existing piece of infrastructure.

The seven primary requirements to use a POU/POE device as a compliance strategy are presented in the following text box (USEPA, 2006b). These requirements are used throughout the report to guide modeling assumptions and conversations with state administrators and CWS stakeholders.

USEPA POU/POE Guidance for SDWA Compliance

1. It is the responsibility of the water system to operate and maintain the POU or POE treatment system
2. The water system must submit and receive approval for a monitoring plan that provides equivalent health protection as centralized treatment prior to installing any POU/POE devices
3. The water system must apply effective technology as approved by the state
4. The device must consider the potential for an increase in heterotrophic bacteria and microbiological safety must be preserved
5. The state must require adequate certification of performance, field-testing or a rigorous design review of the POU/POE devices
6. The water system must ensure all buildings connected to the system has sufficient POU/POE coverage
7. If using POE, the device must not increase the likelihood of the release of corrosive materials such as lead and copper.

We examine POU/POE devices as a compliance strategy to meet the requirements of the SDWA; this is a different context than a homeowner installing a POU/POE device by choice. To use a POU/POE device as part of a CWS compliance strategy, the CWS must meet several requirements: 100% community participation (a device installed at every connection), piloting of devices prior to device selection and installation and state level approval to use these devices. These requirements are discussed in detail in this report. Past studies have examined POU/POE devices outside of the regulatory context of a CWS, which can underestimate the amount of time necessary to implement POU/POE devices in community water systems and the cost associated with conducting compliance monitoring and maintenance activities (Table 1). We focus our analyses on the steps and activities necessary to use POU/POE devices for compliance to the SDWA and highlight how this lens impacts our results.

Table 1: Summary of cost comparison studies

	Sustainability Comparison Study: Assessing Centralized Treatment Upgrades and POU/POE Treatment for Small System Compliance to the SDWA (Kumpel et. al.)	Feasibility of an Economically Sustainable POU/POE Decentralized Public Water System (NSF International)	Comparing centralized and point-of-use treatments of per- and polyfluoroalkyl substances (Bixler et. al.)	Cost of POU vs Centralized Treatment (Speth et.al.)
Year of study completion	2022	2003	2021	2020
Objective of study	Holistically examine the tradeoffs between human health, environmental and economic impacts (triple bottom line) that very small systems may face when choosing a treatment upgrade to remove a specific drinking water contaminant	Evaluate methods for day-to-day management and operation of a centrally-managed POU strategy for small system compliance	Evaluate and compare the triple bottom line of centralized treatment upgrades versus POU devices specifically for the removal of PFAS	Show how the EPA Cost Models can be specifically for POU/POE device using the examples of nitrate, PFAS and perchlorate contamination
Outcome of study	Developed a framework for comparing the triple bottom line of central treatment upgrades needed for SDWA compliance to the triple bottom line of using POU/POE devices as a compliance solution	Demonstrated feasibility of POU as a compliance solution for arsenic treatment in small systems	Demonstrated tradeoffs associated with using centralized versus POU for PFAS removal	Showed the results of the nitrate and perchlorate treatment options for different categories of small systems

Intended end use of study	Provide recommendations to state compliance agencies and POU/POE device manufacturers to aid in the implementation and viability of POU/POE devices as compliance solutions for very small water systems	Encourage decision makers to apply the methods identified in the study when utilizing POU for compliance	Provide decision makers with data and information to aid in future decisions about centralized and POU systems for the treatment of PFAS chemicals	Demonstrate how to use the EPA Cost Models and provide information that compares central to POU/POE cost for nitrate, PFAS and perchlorate treatment
Number of case studies	4	1	1	4 treatment technologies overall, which evaluated POU RO, no case studies, only a desktop study
Physical POU/POE device install or literature review?	Literature review/data collection	Physical install	Literature review/data collection	Literature review
Contaminant(s)	Variable (Arsenic or nitrate)	Arsenic	PFAS	Nitrate, perchlorate, PFAS
Number of connections in CWS	Variable (24-221)	122	6800	Variable, depends upon model being run
Population served by CWS	Variable (50-450)	400	25500	Variable, depends upon model being run
POU/POE technology	POU Carbon, POU RO, POE GFH Media	POU activated alumina followed by GAC	3 POU scenarios - GAC&IX prefilters followed by RO, combined GAC&IX filter, and GAC filter & RO & IX filter	RO
NSF/ANSI certification?	NSF/ANSI 53, 58, and/or 61 respectively	NSF/ANSI 61 ¹	NSF P473 for reduction of PFOA and PFOS	NSF/ANSI 58
POU/POE same technology type as central treatment?	No, POU/POE upgrade is specific to each case study	Yes, looks at new activated alumina	No	No

Costs include all aspects for central system, or upgrade only?	Only includes costs for upgrade, which excludes any existing centralized infrastructure and components	Includes all aspects of the central system, including construction of a new building	Only includes costs for upgrade, which involves development of three new central GAC treatment facilities	Includes all aspects of the central system
Were POU/POE devices discounted for bulk purchase in the cost analysis?	No	Yes - reported as "substantially less than retail" [no % given for the discount]	Yes - 5% discount applied	Unclear ²
Costs take into consideration regulations/practices necessary for Safe Drinking Water Act (SDWA) Compliance?	Yes, comprehensive approach including federal and state-specific regulations	Yes, however the EPA was still drafting federal requirements for POU maintenance and sampling at the time of this study	No, does not consider costs associated with SDWA sampling requirements	Not directly. The EPA Cost models make some assumptions about cost of compliance, however, the results of this study are not state specific
Unit for cost analysis	Total cost per household over 30 years	Monthly cost per household (or connection) ³	Annual net present value per average volume of water used per household per year ⁴	Annualized cost for a volume of water treated

¹Arsenic reduction was not included in NSF/ANSI 53 at the time of this study, but the POU devices were tested against the draft NSF/ANSI 53 protocol prior to installation

²The EPA models use a default discount rate of 7%, which users can adjust directly on the output sheet. However it is unclear if this discount rate is being applied for bulk POU/POE device purchases.

³Assumes a cost recovery of 7% over seven years

⁴Only considered volume of water used directly for cooking and drinking in the POU scenario, while the centralized scenario considers all water used in the household

2 – Selection of Case Studies and Technology Alternatives

2.1 Methods

We began this study by identifying four community water systems (CWSs) as the case studies, and then identified an improvement to the centralized water system and to POU/POE system options appropriate to treat the contaminant of concern for each CWS. We selected four very small water systems (serving a population of fewer than 500 people) for this study in four different USEPA regions to enable examination of the real-world conditions very small systems face in different regional contexts when examining POU/POE devices as a strategy to meet the SDWA regulations. We compared treatment alternatives in the selected communities, including one centralized treatment improvement and two different POU/POE devices in each CWS.

2.1.1 Community Water System Selection

We selected four CWSs from EPA Regions 1, 5, 7, and 9 (Figure 2.1). Initially, Regions 1, 5, 6 and 9 were selected to represent different regions across the United States. Region 7 was substituted for Region 6 after a review of data and reasons explained below; initial results from the CWS identification process include Region 6 and not Region 7 since Region 7 was not initially included in the CWS selection process.

We retrieved violation reports from the Safe Drinking Water Information System (SDWIS) database for each of the selected EPA regions (USEPA, 2017) from 2013-2019. Using these reports, we reviewed the data for maximum contaminant level (MCL) violations and found the top six contaminants most often in violation of an MCL were arsenic, combined radium (226 and 228), fluoride, gross alpha (excluding uranium and radon), nitrate, and total trihalomethanes. From this list of contaminants, we selected arsenic and nitrate as contaminants to focus on in this study. Next, we selected a state within each region with the greatest number of violations for either contaminant, or a state with a high number of violations and of systems in violation of the MCL for the contaminant to narrow our search.

For each state, we then identified a list of eligible CWSs meeting the following criteria:

1. A groundwater supply
2. Violations of either arsenic or nitrate in the past five years
3. Violations of either arsenic or nitrate in more than one year
4. A population served less than or equal to 500 people

Groundwater supplies were included to ensure comparability between water systems and because there are additional treatment requirements for surface water systems that are state specific. Populations less than or equal to 500 people were selected as very small systems per the USEPA's definitions of small systems (USEPA, 2017a). Arsenic and nitrate were selected as focus contaminants due to the large number of systems that have experienced at least one violation of either parameter between 2010-2019. To find systems with potential long-standing problems with either arsenic or

nitrate, we selected communities with more than one violation in the past five years. This allowed us to locate communities with chronic concerns with either arsenic or nitrate that were potentially still experiencing these concerns at the time of our study.

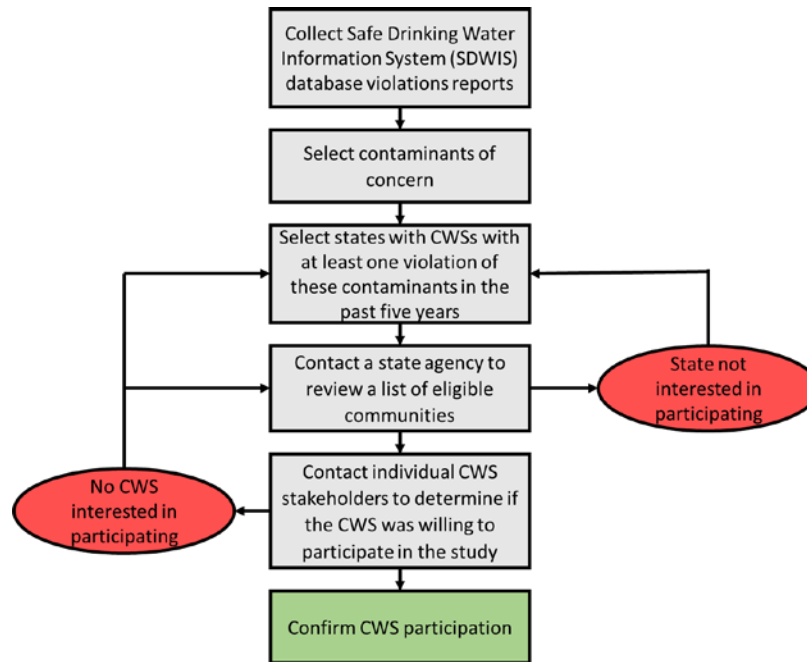

Figure 2.11: Methodology for finding and selecting CWSs for participation in this study

Using these criteria, we identified 12 eligible systems in Region 1 for arsenic contamination, 15 eligible systems in Region 5 for arsenic contamination, 63 eligible systems in Region 6 for nitrate contamination, and, in Region 9, 132 eligible systems for arsenic and 55 for nitrate contamination (Table 2.1). Initially, we decided to pursue arsenic contamination in Region 1 and 5, and nitrate contamination in Region 6 and 9.

After generating a list of eligible CWSs, we then contacted state-level administrators in the corresponding states to introduce the purpose of the project. If a state declined to participate, we returned to the SDWIS data and iterated through the steps outlined in Figure 2.1 to locate another state in the target Region meeting our criteria and generated a new list of eligible CWSs. States declined to participate for several reasons: POU/POE devices cannot be used for regulatory compliance purposes in the state, the systems identified through SDWIS were not ideal communities to work with due to ongoing water quality concerns or projects, or because the state was not interested in “promoting” POU/POE devices as a solution for very small water systems. If a state-level administrator was willing to assist in reviewing and contacting the eligible CWSs, we selected three communities to contact in each state. The state-level administrator provided an initial introductory email to the CWS. In the event that a CWS within a given state declined to participate, we collaborated with state-level

administrators to continue working through the list of eligible communities until a CWS interested in participating was found. If no CWS was found with the help of the state-level administrator, we identified another state within the region and iterated through the methodology in Figure 2.1. Using the methodology presented in Figure 2.1, we were able to successfully select communities in Region 1, 5 and 9. A CWS with arsenic contamination meeting the eligibility criteria and willing to provide data for the study was found in each of Region 1 and Region 5. In Region 9, CWSs with nitrate contamination were identified, however, the majority of these CWSs did not have centralized treatment and distribution in place. As a result, we worked with state administrators in Region 9 to locate a CWS with arsenic contamination and existing centralized treatment and distribution.

Table 2.1: Number of eligible CWSs by region and contaminant

Region	Contaminant	Number of Eligible CWSs
1	Arsenic	12
5	Arsenic	15
6	Nitrate	63
9	Arsenic	77
	Nitrate	55

Region 6 was initially selected as the fourth EPA region, with a focus on nitrate contamination. However, after working with three different states within the region, we were unable to identify an interested CWS. Subsequently, we connected with researchers at the University of Lincoln Nebraska to determine whether a community in Nebraska (Region 7) would be interested in participating in this study. We confirmed participation in a Nebraska CWS in place of a CWS from Region 6. Region 7 is not included in Table 2.1, as we did not use the SDWIS data set to identify eligible CWS in the initial months of this project. The CWS in Region 7 meets the initial criteria used in the analysis of the SDWIS data: a groundwater source, a population less than 500 people and chronic concerns with nitrate contamination in the system. While the CWS selected in Region 7 has not yet had an MCL violation of nitrate, nitrate levels in multiple groundwater wells have been increasing for the past 5 years and the CWS was already considering treatment alternatives at the time of this study.

2.1.2 Selection of Alternatives for Comparison

2.1.2.1 Centralized Treatment Improvements

We next worked with each CWS to select a centralized treatment improvement for each system to model. We first contacted the relevant CWS stakeholders to discuss the current centralized system structure, and obtained prior system assessment reports, sanitary surveys, water quality data, and other relevant reports such as engineering consultant reports. Using this information, we consulted the CWS operators and state administrators to determine an appropriate improvement to the existing centralized treatment system. Centralized system improvements focused specifically on feasible options for removing the contaminant of concern chosen for each CWS; we did not consider additional

components in the triple bottom line approach related to overall treatment system performance or improvements. We chose treatment improvements that could be easily added to the current centralized infrastructure where possible and focused on technologies designed to specifically remove either arsenic or nitrate.

2.1.2.2 POU and POE Devices

According to the EPA Guidance on POU/POE devices for small water systems (USEPA, 2006b), if a certified POU or POE device is available for a given contaminant, the certified devices must be considered first. If a certified device is unavailable, other devices tested for performance may be considered for use for compliance purposes. Certified devices can be found from the following certifying organizations: NSF International (NSF), the Water Quality Association (WQA), the Underwriters Laboratory, the Canadian Standards Association (CSA International) (USEPA, 2006) and through listings provided by the International Association of Plumbing and Mechanical Officials (IAPMO). We determined two standards were applicable to our study: NSF/ANSI 53 (Health Effects) for arsenic contamination and NSF/ANSI 58 (Reverse Osmosis systems) for both arsenic and nitrate contamination. While NSF/ANSI testing protocols allow for both trivalent and pentavalent arsenic reduction claims, we found no devices certified to the trivalent arsenic reduction claim at the time of the initial device search in January 2021. We compiled lists of POU and POE devices certified to NSF/ANSI 53 and NSF/ANSI 58 from NSF International, WQA, and IAPMO listings for review. A list of the number of records found from NSF listings is presented in Appendix B.

To select two POU or POE devices for each CWS, we used state level regulations to determine which type of device is allowable at a state level for compliance purposes in small CWSs (Figure 2). We considered at least 2 different devices per CWS to ensure our methodology can be translated in the future to other devices and removal claims. In Region 1, we selected a community in New Hampshire, in Region 5 a CWS in Illinois, in Region 7 a CWS in Nebraska and in Region 9 a CWS in California. In the states selected for both Regions 1, 7, and 9, POU devices are allowed as a solution for compliance with the SDWA, with Region 9 specifying POU devices are only allowed if no alternative centralized treatment or consecutive connection is a viable solution. In Illinois, only POE devices are allowed as a solution to comply with the SDWA; POU devices may only be used as an emergency measure and must be removed from use once the emergency has passed. Through a conversation with Illinois state administrator, POU devices have been previously implemented for inorganic contaminant remediation, but no systems currently employ POE devices.

Next, we identified the relevant NSF/ANSI standards applicable to the selected contaminants in each CWS as described in Table 2.2 to narrow down the number of devices to consider. Through discussions with stakeholders in each CWS, we chose one POU device certified to NSF/ANSI 53 (an adsorptive media technology) and one POU device to NSF/ANSI 58 (reverse osmosis) each for arsenic contamination in Region 1 and Region 9. In Region 7, we selected two different POU devices certified to NSF/ANSI 58 for nitrate reduction and in Region 5, we selected two POE devices certified to

NSF/ANSI 53. Figure 2.2 presents the selection criteria used to find two devices applicable to each CWS.

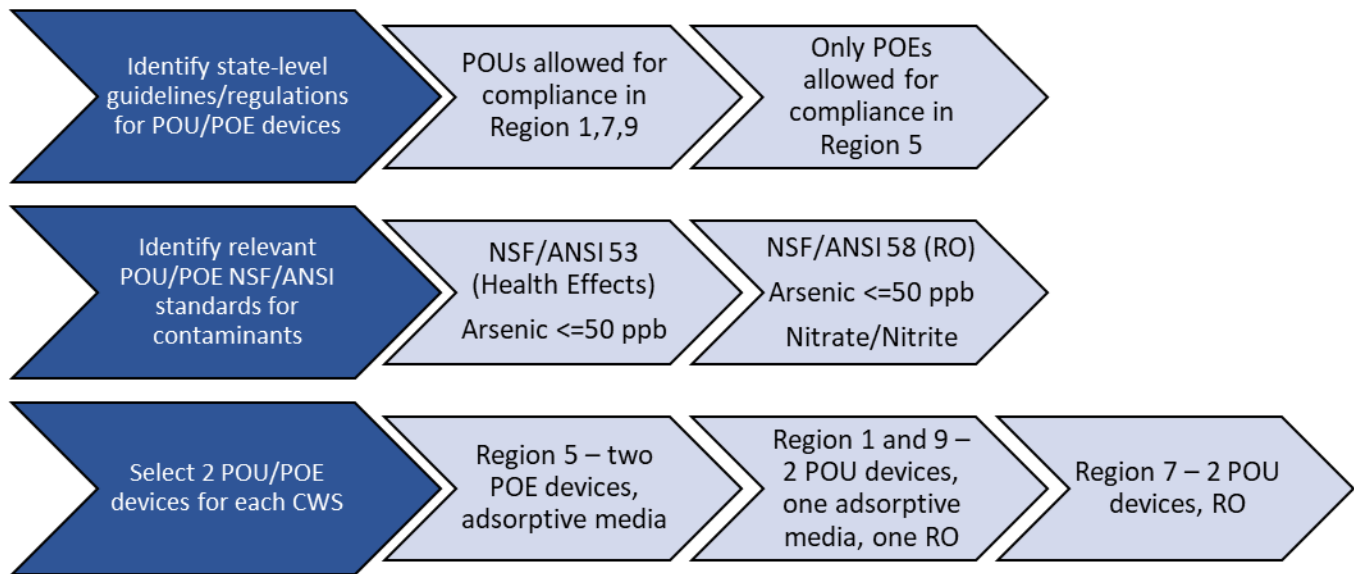

Figure 2.2: Criteria used to select 2 POU/POE devices for each CWS.

The complete list of eligible POU and POE devices identified for consideration in this study are shown in Appendix B with anonymized company names and model numbers. Table B1 presents the eligible POU devices certified to NSF/ANSI 53, Table B2 presents the eligible POU devices certified to NSF/ANSI 58 and Table B3 presents the POE devices available through multiple listings. Due to the high cost associated with POE RO units and the absence of an NSF/ANSI 58 testing protocol for POE RO devices, we limited our focus to POE devices certified to NSF/ANSI 53. After reviewing the NSF/ANSI POE listings, we expanded our search to CSA B483.1 listings and devices with certified NSF/ANSI 61 media to find additional POE devices.

2.1.3 Data collection for selected treatment alternatives

After selecting each alternative, we then gathered relevant information from the CWS stakeholders and POU/POE manufacturers to begin the triple bottom line analysis. For centralized treatment we requested the following types of information: (1) historical water quality data, (2) cost information (e.g., utility bills and inventory sheets), (3) the removal rate of either arsenic or nitrate for each centralized treatment option and (4) other relevant information necessary to create an inventory of system components. For POU/POE devices, we requested information from device manufacturers and distributors, including: (1) device manuals, (2) component listings, (3) performance data including certified contaminant removal rates and efficiencies, and (4) the useful life of device components. If data could not be obtained from either CWS stakeholders or device manufacturers, we consulted

literature to locate relevant values for removal rates and the cost of components. This included the EPA Arsenic Demo Reports generated by the National Risk Management Laboratory for information on useful life, removal rates by specific technology types, and cost information. We also examined the documentation of the EPA work-breakdown structure (WBS) cost models for specific technologies to fill data gaps. When literature values were used to fill data gaps, we included both best-case and worst-case values to include in our data analysis.

Using the data obtained from CWS stakeholders, literature, and POU/POE manufacturers, we next constructed process flow diagrams for each improvement to document the components of each system alternative. This study focuses on improvements to a water system above and beyond the current treatment and distribution processes; as a result, we documented the current system components and the new necessary improvement components to show where the improvement integrates with the existing infrastructure where appropriate. Flow diagrams from EPA design manuals for arsenic and nitrate removal (USEPA, 1978, USEPA, 2003a, USEPA, 2003b, USEPA 2006a) were used to generate a basic flow diagram for each improvement. Then we indicated CWS specific alterations to capture the components to include in the triple bottom line analysis. Flow diagrams for POU/POE devices were built from figures presented in the EPA POU/POE Guidance document (USEPA, 2006b) and then altered where necessary to reflect the specific devices selected for this study.

2.2 Selection process results

2.2.1 Selected Communities

After iterating through the CWS selection methodology (Figure 2.1), we identified a CWS in both Region 1 and Region 5 meeting our criteria with arsenic as the contaminant of concern. In Region 9, we initially investigated communities with nitrate concerns, however, there were few CWSs in California with nitrate contamination that have either a centralized treatment facility or centralized distribution systems. As a result, we identified a CWS in Region 9 with arsenic contamination (in addition to uranium contamination) that met our criteria. Initially, we contacted state administrators in three different states in Region 6 to identify a CWS with nitrate contamination willing to participate in this study. However, as described earlier, we could not identify a candidate CWS and instead identified an eligible system in Region 7 (Nebraska). Through conversations with our contact in Nebraska, we identified a CWS with known nitrate issues interested in examining POU/POE devices as a solution. The participating CWSs are presented in Table 2.2.

Table 2.2: Selected community water systems (CWSs) for study.

Region	State	Contaminant	Population	Connections	Source Water Type	Current Treatment Method	Average contaminant concentration	
							Well	Treated
1	New Hampshire	Arsenic (As)	50	24	Ground water	Adsorptive Media Filtration	10.8 µg/L ¹	8.3 µg/L ¹
5	Illinois	Arsenic	450	221	Ground water	Pressure Sand Filtration and Aeration	21.6µg/L ²	9.2 µg/L ²
7	Nebraska	Nitrate	128	75	Ground water	Distribution from wellheads	8.6 mg/L ¹	9.4 mg/L ³
9	California	Arsenic and Uranium (U)	41	29	Ground water	Adsorptive Media Filtration	Well #1: As = 55 µg/L ⁴ U = 22 PCi/L ⁴ Well #2: As = 4.4 µg/L ⁴ U = 24.2 PCi/L ⁴	As = 19.6 µg/L ⁴ U = 24.9 PCi/L ⁴

¹Represents data from 2013-2020

²Represents data from 2002-2020

³Data point represents the concentration at the CWS wellhead distribution sampling location as there is no treatment currently present.

⁴ Represents data from 2016-2020

In Region 1, we selected a CWS in New Hampshire serving approximately 50 people through 24 service connections. The current treatment system uses adsorptive media filtration to treat 50% of the water volume from two combined wells. The remaining 50% of well water is untreated and blended with the treated water prior to distribution. System data revealed an average arsenic concentration in the combined groundwater wells of 10.8 µg/L with a treated water average of 8.34 µg/L based on data between 2013 and 2020. The system has experienced several past violations for arsenic contamination, with values exceeding the MCL for arsenic (10 µg/L) more frequently prior to 2013, but with consistent arsenic concentrations between 8-11 µg/L between 2013 and 2020. In New Hampshire, the MCL for arsenic is 5 µg/L and thus the state administrators identified this CWS as a system that would benefit from increased treatment to remove arsenic below the state MCL.

In Region 5, we selected a CWS in Illinois serving approximately 450 people with 221 service connections. The system serves both households connections and a large industrial connection within the area. The current treatment system utilizes an aeration tower to treat water from a groundwater well, followed by chlorine injection and subsequent pressure sand filtration. The aeration process removes particulate iron from the well prior to filtration. Filter media consists of a sand media marketed as a greensand filtration media designed to remove both iron and arsenic from water. The total arsenic concentration in the active well averaged 21.6 µg/L with an average treated water concentration of 9.2 µg/L. Iron concentrations in the wells exceed 3000 µg/L, with an average iron to arsenic ratio of approximately 55:1.

In Region 7, we selected a CWS in Nebraska serving approximately 150 people with 71 services connections. The CWS consists of three groundwater wells, only one which is active and distributes from the wellhead with no current treatment or water storage prior to distribution. The wellhead is contained in a small shed prior to pumping wellhead water directly from the wellhead into the distribution system. Nitrate levels in the groundwater wells in this system have been increasing over time and the CWS has been considering applying for permits to drill an additional well in the town. However, there are concerns with rising nitrate levels in nearby wells and cross-contamination of new wells as a result of the aquifer structure. Nitrate levels in the active well averaged 8.6 mg/L as N between 2013 and 2020, with a nitrate level of 9.34 mg/L recorded at the wellhead distribution sampling location.

In Region 9, we selected a CWS in California serving approximately 29 connections and an average of 41 people. The CWS has both permanent and transient residents; therefore, the population presented in Table 3 represents the average number of people present in the system year-round. This water system has both arsenic and uranium contamination in two different groundwater wells and has primarily focused on removing arsenic from the wellheads. Well #1 has an average arsenic concentration of 55 µg/L and an average uranium concentration of 22 PCi/L. Prior to 2020, Well #1 was the primary active well and was treated via two adsorptive media filters. After 2020, the CWS switched to using Well #2 after the adsorptive media filters failed before the manufacturer's indicated useful life of the media. Well #2 has an average arsenic concentration of 4.4 µg/L and an average uranium concentration of 24.2 PCi/L. The smaller arsenic concentration in Well #2 has helped to reduce arsenic MCL violations but uranium remains a concern. Arsenic and uranium levels measured in the distribution system measure 19.6 µg/L and 24.9 µg/L respectively. Arsenic levels in 2016 were recorded at 37, 41 and 48 µg/L in the distribution system in 2016. The water system is not currently using the adsorptive media system due to its early failure and the switch to Well #2 and has been considering water treatment solutions to remove both arsenic and uranium. Due to water quantity concerns, CWS stakeholders indicated they were interested in blending the two wells to ensure daily water demands are met over time.

We addressed both arsenic and uranium contamination in Region 9 as separate sources of contamination when examining results for comparisons between CWSs in different regions. When providing a comparison between other regions (notably Region 1), we examined arsenic alone for an accurate comparison. When completing our analyses in Region 9, we focus on arsenic alone for comparison to other CWSs, and the combined contamination from both arsenic and uranium when making a recommendation specifically for Region 9. For example, when comparing centralized treatment to POU/POE devices within Region 9, we examined removal of both arsenic and uranium, but when we compare the final results between Region 1 and Region 9, we examined only arsenic removal.

2.2.2 Selected technology alternatives

2.2.2.1 Centralized treatment improvements

In Region 1, arsenic is currently removed from two groundwater wells using an adsorptive media (granular ferric hydroxide media) filtration system. Only half of the flow produced from the two wells is currently treated at the central facility, with the remaining half of the flow bypassing treatment and then blended with treated water before distribution to customers. Through conversations with CWS stakeholders, we determined the current system has functioned well over the past ten years and the CWS is satisfied with the adsorptive media performance. Furthermore, there is sufficient space available in the current treatment facility to house an additional filtration unit and thereby treat the full flow from the two wells. The cost of the media, the size of the current filter and the amount of water to be treated by this improvement are well known and documented, making the addition of a second filter in series a viable improvement for the Region 1 CWS.

In Region 5, arsenic is currently co-precipitated with iron via aeration and pressure sand filtration. The current system consists of the following components: two wells providing water with an iron to arsenic ratio of 55:1, an aeration column, pre-chlorination, followed by filtration with pressure sand filters with a silica sand filtration media nominally able to remove iron. The media in this system was replaced recently, in 2018, which helped to lower the mean treated arsenic concentration below the MCL of 10 µg/L, but there are still concerns arsenic will not be effectively removed long-term. There is no current data available detailing the fraction of arsenic in the trivalent (As (III)) form compared to the pentavalent (As (V)) form. After conversations with stakeholders in this system, we decided to focus on improving pre-oxidation of As (III) to As (V) for this study, postulating the sand filters were only removing As (V) effectively. Therefore, in the Illinois system, the centralized improvement will consist of altering the order of pre-oxidation steps by placing pre-chlorination ahead of aeration to oxidize As (III) to As (V).

In Region 7, water is blended from two wells high in nitrate and then distributed to the community. No current treatment processes exist in this system. After consulting with the CWS, we determined the CWS has been exploring drilling new wells to alleviate nitrate contamination. However, groundwater studies in this community have shown increasing nitrate levels in both the community and neighboring

wells, raising the concern that any new well could suffer from surface and subsurface contamination. A consulting company working closely with this community recommended the following alternative choices: ion exchange, nanofiltration or reverse osmosis, or a consecutive connection to a neighboring system. Using the EPA cost models for ion exchange, membrane filtration, and consecutive connection (interconnection), we screened these different options to determine which may be more reasonable in the CWS based on initial capital cost. We determined interconnection was at least four times more costly than centralized ion exchange, and reverse osmosis and nanofiltration were expensive alternatives due to maintenance, operation and brine disposal concerns. We therefore selected centralized anion exchange using a nitrate selective resin as the centralized improvement alternative in Region 7. With the addition of centralized treatment, the system in Region 7 will also require chlorine disinfection to comply with treatment requirements in Nebraska. As a result, the cost and components of a chlorine disinfection system are included as part of the centralized treatment solution in subsequent analyses. We also include post-treatment water storage in our centralized improvement analysis since there is currently no water storage in the community.

In Region 9, the current treatment facility is designed to remove arsenic from groundwater wells using an adsorptive media (granular ferric hydroxide media) filtration system. The current treatment facility was designed to remove arsenic from Well #1, but the community switched to Well #2 as the primary source in the past five years. As a result, the CWS is currently dealing with uranium levels in exceedance of the 30 PCi/L MCL and has lingering arsenic contamination. The current treatment facility is not in operation, but the infrastructure is relatively new, and the community stakeholders are interested in optimizing the current system to remove arsenic. Through conversations with stakeholders from this community, the following options were considered:

- 1) Blending Well #1 and Well #2 and removing arsenic centrally via the current adsorptive media;
- 2) Removing arsenic from Well #1 centrally with the current infrastructure and removing Uranium with a POU device;
- 3) Removing uranium centrally with a POE RO device.

We selected a centralized alternative based on the liquid waste disposal and spent media disposal options best suited to the community. We consulted the regional Water Board to determine the permitting requirements for the disposal of brine from either RO or ion exchange systems and assessed the current waste disposal methods available in the community. The community currently relies on nine septic tanks that would be unlikely to be able to handle the brine from a centralized RO system without extensive additional piping. As a result, we decided to examine ion exchange with an option to dispose spent media to a landfill or an evaporative pond on site.

2.2.2.2 POU/POE devices

The decision making process to select POU/POE devices is presented in Figure 2.3 to show the criteria used to refine and improve our list of eligible POE adsorptive media devices for Region 5 and POU RO devices for Region 1, 7 and 9. Initially, we only identified one POE device currently certified to NSF/ANSI 53. We expanded our search to include device listings from IAPMO, resulting in the identification of additional devices certified to CSA B483.1, a Canadian standard for devices installed in plumbed systems (IAPMO, 2021) which had a device with NSF 53 listed. We also performed a search of the NSF/ANSI 61 listings to identify adsorptive media with an NSF/ANSI 61 certification (NSF, 2021c). Using this information, we then searched through both manufacturer websites and water filtration distributor websites offering “whole house” water filtration systems. We compiled a list of POE devices with media certified to NSF/ANSI 61 and included only devices where we could verify the presence of a performance indicator device (PID) and a filter housing also certified to NSF/ANSI 61 in our final list of POE devices to consider for Region 5. This yielded a total of 7 devices to examine for Region 5 (Appendix B, Table B3). Figure 2.3, Panel 1, shows the process of expanding the search parameters for POE devices to find the second POE device to use in this study.

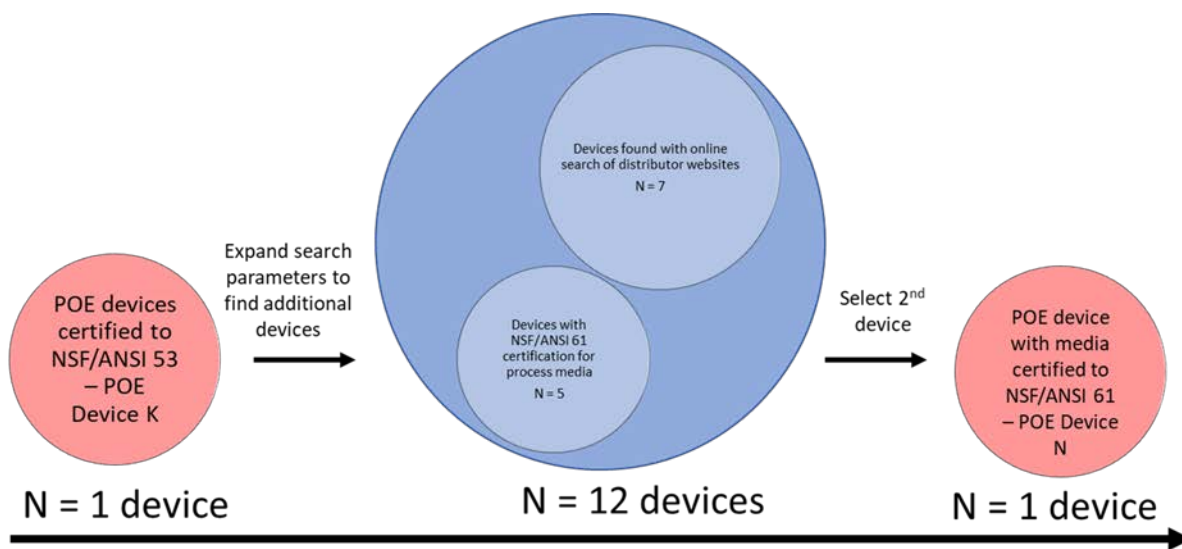

Methodology to select 2 POE adsorptive media units from device listings (Region 5)

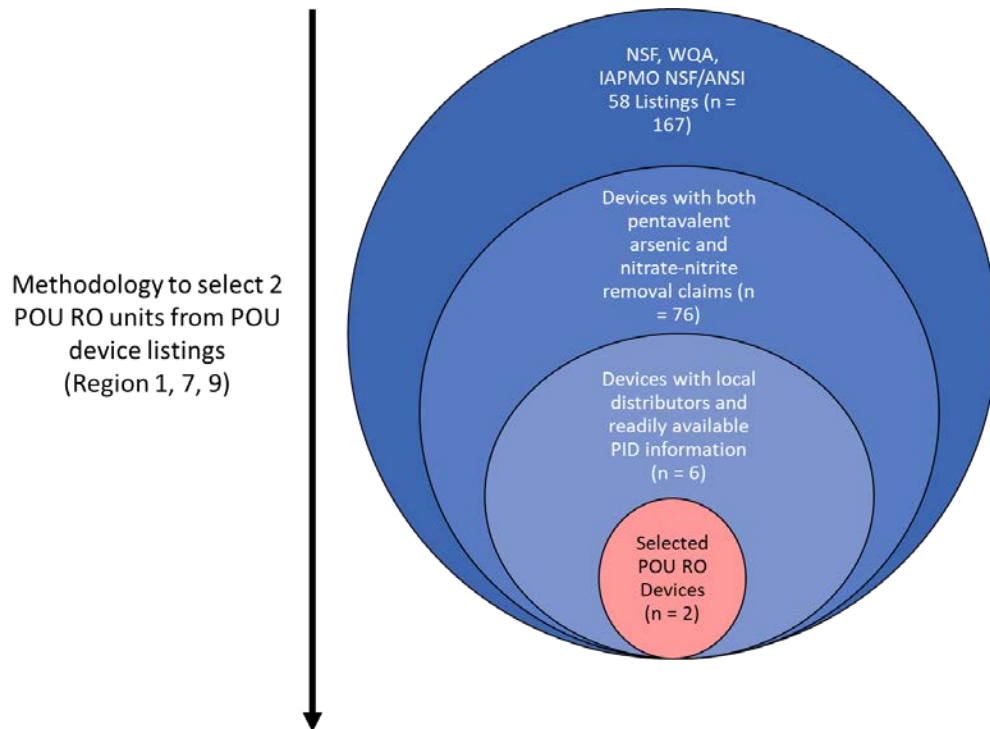

Figure 2.3: We expanded our search for POE devices from the one device we located using device listing search tools to include a total of 12 devices found through online searches and then narrowed the list of 12 devices to find the second POE device for Region 5 (Panel 1). We narrowed the list of POU RO devices for Regions 1, 7, and 9 from 167 total devices to 2 RO devices by selecting devices certified for both arsenic and nitrate removal, and devices available from local distributors and had performance indicator device (PID) information readily available (Panel 2).

After searching for NSF/ANSI 58 listings, we identified 167 devices from the combined listings from NSF, WQA and IAPMO. First, we selected only devices certified for both pentavalent arsenic removal and nitrate-nitrite removal claims for NSF/ANSI 58 to ensure that we can compare device performance across communities (i.e., Region 1 versus Region 9) and across contaminants (arsenic vs. nitrate). We used the guidance from the EPA (USEPA, 2006b) to identify components necessary for POU/POE to be used for regulatory compliance, including the presence of performance indicator devices (PIDs). While most devices certified to NSF/ANSI 58 listed on either the NSF, WQA or IAPMO websites will have PIDs as a result of certification requirements, we decided to approach the search from the lens of a CWS operator or manager. We therefore searched for device manuals and product listings that were readily available to customers and have easily accessible information on the presence of PIDs. We further refined our search by identifying devices available through local distributors and whether replacement components or media were readily available in the EPA Region or state where the CWS is located. This criterion was based on feedback from state administrators who stressed the importance of finding devices locally to ensure that maintenance and repair activities can be completed in a timely manner

to ensure compliance. Six devices were identified using these criteria for consideration (Appendix B, Table B2) (Figure 2.3, Panel 2). From these devices, we selected the same RO unit (Company D, Device D1) for Region 1, 7 and 9, listed as Device D, to enable a comparison of context in costing and exposure analyses. We selected a second RO device (Company G, Device G1) for Region 7 for nitrate removal to complete our selection of POU/POE devices.

In Regions 1 and 9, POU devices are allowed at a state level for compliance with the SDWA. POU devices have been previously piloted and installed in CWS in the Region 1 state; through conversations with state level administrators, we learned how the state approves selected POU devices in addition to other state level requirements for use of POU. In Region 1, we selected a carbon fiber adsorptive media POU certified to NSF/ANSI 53 and an RO POU certified to NSF/ANSI 58. The same guidelines hold for California in Region 9, where POU are allowed for compliance, and we also selected the same NSF/ANSI 53 and NSF/ANSI 58 devices for the Region 9 system to allow for comparisons between the context in each CWS as opposed to comparisons of devices. Devices were selected based on local availability, cost (one low cost and one high-cost option) and evidence from manufacturers that a PID was present (Table 2.3).

In Region 5, only POE devices are allowed for long term compliance to the SDWA. Using the IAPMO device listings presented in Table B3 in Appendix B, we determined only Company K produced devices certified to NSF/ANSI 53 that could be used in this study. We therefore identified a list of 7 POE devices by searching for NSF/ANSI 61 certified adsorptive medias, and through online searches of manufacturer websites. From this list of 7 devices, we identified a device from Company N with a media certified to NSF/ANSI 61, as well as readily available filter housings certified to NSF/ANSI 61 as the second POE option in Region 5 (Table 2.3).

In Region 7, we selected two POU RO devices certified to NSF/ANSI 58 for nitrate/nitrite removal. From a list of 6 eligible devices (presence of a PID, availability of the device, NSF/ANSI 58 certification for both arsenic and nitrate removal), we identified two RO POU devices. The first device from Company D was chosen to be consistent with that selected in Regions 1 and 9 to enable comparison. The second device is from Company G and was selected for both its availability in Region 7 and because it is approximately twice the capital cost as Device D1, providing for a comparison of low and high-cost devices (Table 2.3). Capital costs for each device are listed in Appendix B and E.

Table 2.3: Selected water treatment system improvements for each community

Region	Current Centralized Treatment	Centralized Upgrade	POU/POE Device #1			POU/POE Device #2		
			Company and Model	Type of Device	Certification	Company and Model	Type of Device	Certification
1	Treatment of 50% of the flow rate from the GW via adsorptive media filtration	Treatment of 100% of the flow rate by adding an additional filtration module	Company B Device B2	POU adsorptive media	NSF/ ANSI 53	Company D, Device D1	POU reverse osmosis	NSF/ ANSI 58
5	Aeration and Pressure Sand Filtration for co-precipitation of arsenic with iron	Enhance pre-oxidation by moving pre-chlorination step ahead of aeration	Company K Device K1	POE adsorptive media	NSF/ ANSI 53 and CSA B483.1	Company N, Device N2	POE adsorptive media	NSF 61
7	Wellhead and Distribution System	Centralized anion exchange with a nitrate selective resin	Company G Device G1	POU reverse osmosis	NSF/ ANSI 58	Company D, Device D1	POU reverse osmosis	NSF/ ANSI 58
9	Adsorption Media for Arsenic removal + hypochlorite disinfection	Centralized anion exchange with a strong base anion resin	Company B Device B2	POU adsorptive media	NSF/ ANSI 53	Company D, Device D1	POU reverse osmosis	NSF/ ANSI 58

2.2.2.3 Initial data collection results and water treatment system improvement diagrams

After selecting centralized treatment improvements and POU/POE devices, we constructed process flow diagrams for each alternative to highlight the components included in the triple bottom line analysis. Figure 2.4 shows the centralized treatment improvement for Region 1, highlighting additional components needed to install and operate a second GFH adsorptive media filter. Components in grey represent components of the system already in place that will not be included in our analysis as they do not constitute an “improvement” to the system.

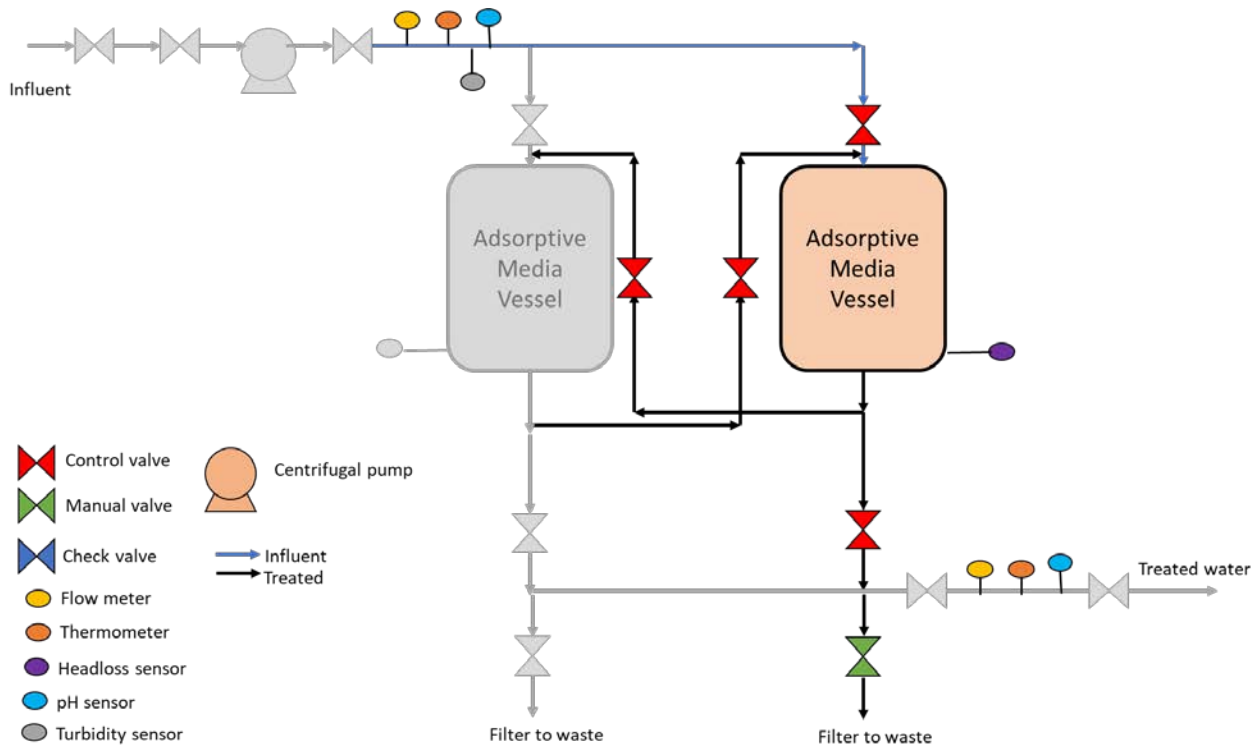

Figure 2.4: Components of the centralized treatment improvement for Region 1. Note that components in grey already exist that and will not be included in the analysis but are shown for illustrative purposes only.

Similarly, Figure 2.5 shows a generalized diagram of a POU RO unit based on documentation from the EPA POU/POE Guidance document (USEPA, 2006b). Components include pre-filters (both granular activated carbon (GAC) and sediment removal), the RO membrane, flow meters and additional piping. The components listed in these diagrams provide a starting point for both the LCA and LCC analyses explained in detail in Sections 4 and 5 respectively. Appendix A provides additional process flow diagrams of each CWS centralized improvement and additional POU/POE devices to document the components considered in the triple bottom line analysis.

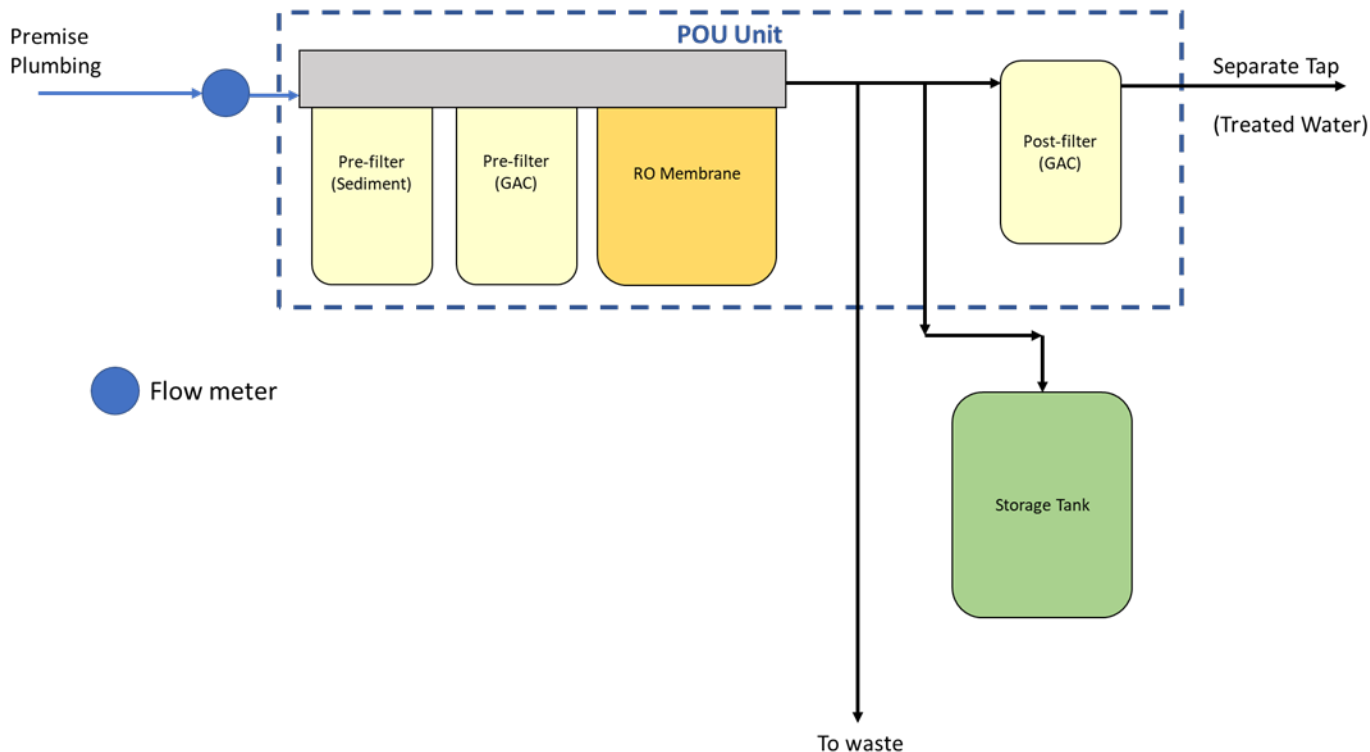

Figure 2.5: Components of a POU RO device selected for Region 1.

Specific design considerations for each improvement such as contaminant removal rates, sizing of centralized treatment vessels and operational parameters such as empty bed contact time (EBCT) were recorded for each improvement. Removal rate information is presented in the exposure assessment component of this report in Section 3.

The process flow diagrams presented in Figure 2.4 and Figure 2.5 were used to calculate the amount of material needed for each alternative for the life cycle analysis component of the triple bottom line analysis. The process flow diagrams were also used to evaluate the material and number of components for the life cycle costing analysis (Chapter 4) and life cycle assessment (Chapter 5).

3 – Exposure Assessment

3.1 Methods

To quantify exposure, we calculated both the estimated chronic daily intake (CDI) and the average daily dose (ADD) associated with each water treatment system improvement. CDI was used to quantify potential lifetime health impacts using both a deterministic approach and a probabilistic approach. Deterministic exposure provides only a single point estimate of exposure, while probabilistic exposure was used to generate a range of values to capture best- and worst-case exposure scenarios. ADD was used to examine exposure duration to quantify the time available to implement an alternative over an averaging time of 30 years. CDI and ADD values were calculated for both *pre-* and *post-intervention* concentrations: *pre-intervention* refers to the exposure in the CWS in its current state, while *post-intervention* refers to the exposure associated with water in the CWS after either installing a centralized improvement or a POU/POE device. We examined exposure from three routes: oral during consumption of drinking water, inhalation of aerosolized water during showering, and dermal contact with water during showering or bathing. Ultimately, we estimated oral and dermal exposure only due to data gaps in the literature surrounding inhalation exposure reference values and a lack of equations available to accurately quantify the concentration of contaminants in aerosolized water droplets.

In Regions 1 and 5 we examined exposure to arsenic contamination via the oral and dermal exposure routes. In Region 7, we examined exposure to nitrate through the oral exposure route only. In Region 9, we addressed both arsenic and uranium in our exposure assessment. Arsenic contamination via oral and dermal routes is included in our analysis while only the oral exposure route for uranium is considered. Detailed calculations and methods for each analysis are explained in detail in the following paragraphs.

3.1.1 Estimating contaminant exposure

Contaminant exposure was calculated for the oral and dermal exposure routes using EPA guidance for exposure assessments (USEPA, 1992). We have provided a discussion of the calculations for CDI, hazard quotient, total carcinogenic risk, and maximum likelihood estimates for each exposure route separately. Difference in deterministic and probabilistic calculations are presented once for oral exposure; the same procedures apply to the dermal exposure route. Input values to each set of equations are provided for each exposure route for clarity. Reference values such as no observable adverse effect level (NOAEL), lowest observable adverse effect level (LOAEL), reference dose, and oral slope factors are provided specific to exposure routes when applicable and by specific contaminant. A discussion of the challenges associated with calculating exposure via inhalation is also provided for completeness.

Oral exposure.

Deterministic Calculations. For each CWS, the pre-intervention exposure was calculated using CDI (units of mg/kg-day) and the historical concentrations of a given contaminant in a CWS (Equation 3.1) (USEPA, 1992). CDI is the product of the concentration (*C*), intake rate (*IR*), exposure frequency (*EF*), exposure duration (*ED*), divided by the product of the average lifetime (*LT*), and bodyweight (*BW*). The average contaminant concentration in both groundwater wells and treated water was used to calculate CDI values. Only treated water concentration calculations are shown in the subsequent results.

$$CDI = \frac{C * IR * ED * EF}{BW * LT} \quad (3.1)$$

Total carcinogenic risk (TCR) is the product of the CDI and the oral slope factor (units of kg-day/mg), which is then subsequently used to produce an estimate hazard quotient (HQ) (Equation 3.2). The oral slope factor (SF) is a contaminant-specific value determined through epidemiological studies and used as a conversion factor to express exposure risk in unitless terms (USEPA IRIS, 1991). Hazard quotient (HQ) is found by multiplying the TCR value by the oral slope factor. HQ values are then added for each contaminant of concern to provide an overall estimate of exposure risk (Equation 3.3). For the purposes of this study, the HQ in each community is the sum of the HQ for individual contaminants. The HQ is equal to the exposure only from the contaminant of concern: arsenic in Region 1 and Region 5, and nitrate in Region 7. In Region 9, the HQ for arsenic only was calculated for comparison purposes with Region 1. We also planned to calculate the HQ for both arsenic and uranium in Region 9 by adding the HQ values to arsenic to uranium. In all scenarios, if the HQ is greater than one, then adverse effects from a contaminant that are potentially carcinogenic in nature exist in the system.

Carcinogenic risk was not calculated for nitrate (the contaminant in Region 7), as there are no data supporting carcinogenic effects of nitrate and no documented oral slope factor to calculate a HQ (USEPA IRIS, 2021b). In Region 9, the HQ for arsenic equals the total carcinogenic risk; a complete evaluation of carcinogenic potential for uranium has not been conducted by the US EPA IRIS program (US EPA IRIS, 1989) and there is currently no oral slope factor available for uranium in literature. Currently there have been no studies have been entered into the IRIS database that confirm uranium is a carcinogen. We calculate the total exposure using CDI for both arsenic and uranium, however, calculations for total carcinogenic risk in Region 9 only represent the carcinogenic risk from arsenic.

$$HQ = TCR * Oral\ Slope\ Factor \quad (3.2)$$

$$Carcinogenic\ Risk = \sum_{i=1}^n HQ_i \quad (3.3)$$

Where a HQ could be calculated, carcinogenic risk was then used to find the maximum likelihood estimate (MLE) for arsenic (Equation 3.4):

$$MLE = TCR * DWUR * BW_{adjusted} \quad (3.4)$$

The MLE value provides an estimate of the number of people in a population of 10,000 people who are impacted by carcinogenic risk from a given contaminant. For example, an MLE value of 4.0×10^{-5} , translates to 4 people impacted by arsenic contamination per 10,000 people. In Equation 3.4, the drinking water unit risk (DWUR) is a value specific to a given contaminant. A DWUR of 5×10^{-5} per $\mu\text{g}/\text{L}$ is available for arsenic through the USEPA IRIS database (USEPA IRIS, 1991); no DWUR value for nitrate or uranium has yet been calculated due to a comparatively small body of epidemiological literature evidence for these contaminants (USEPA IRIS, 2021b, USEPA IRIS, 1989). Reference values from the World Health Organization for acceptable MLE values for cancers caused by arsenic contamination are in Appendix C, Table C1.

Probabilistic exposure. CDI was calculated as a range of values based on probabilistic modeling (Table 3) using the same equations described above. A deterministic analysis was used to provide a baseline average and median CDI and is a point estimate only. The probabilistic analysis provides a range of exposure values to estimate the best- and worst-case exposures for specific percentiles in a given population.

Probabilistic estimates were calculated by randomly generating a normal or lognormal distribution of 1000 data points, centered at a mean equal to the deterministic values in Table 3.1. For example, for intake rate, a normal distribution with 1000 data points was centered on 2 L/day intake which generated intake values ranging from 0 to 4 L/day to simulate both lower and higher than average water intake by individual members of the community water system population. Using the distributions for each variable, we then calculated a distribution of CDI values and extracted representative percentiles per the USEPA's exposure assessment method guidance (USEPA, 1992).

The 50th, 90th, 95th, 98th, 99th and 99.9th percentiles were selected as representative metrics for our analysis. The 50th percentile represents the Central Tendency of the distribution, the 90th-98th percentile represents the Reasonable Worst-Case Exposure, the 98th percentile represents the Maximum Exposure, the 90th -99th percentile represents the reasonable maximum exposure (RME), the 99.9th percentile represents the Bounding Estimate; any value greater than the 90th percentile represents a high-end estimate of exposure (Figure 3.1) (USEPA, 1992). Once each percentile was calculated, these exposure values were compared to literature values for the NOAEL and LOAEL of each contaminant to determine an approximate percentile of the population exposed to a contaminant. Probabilistic exposure estimates expand upon the point estimates from the deterministic exposure assessment, providing worst case exposure assessments for a conservative estimate of exposure.

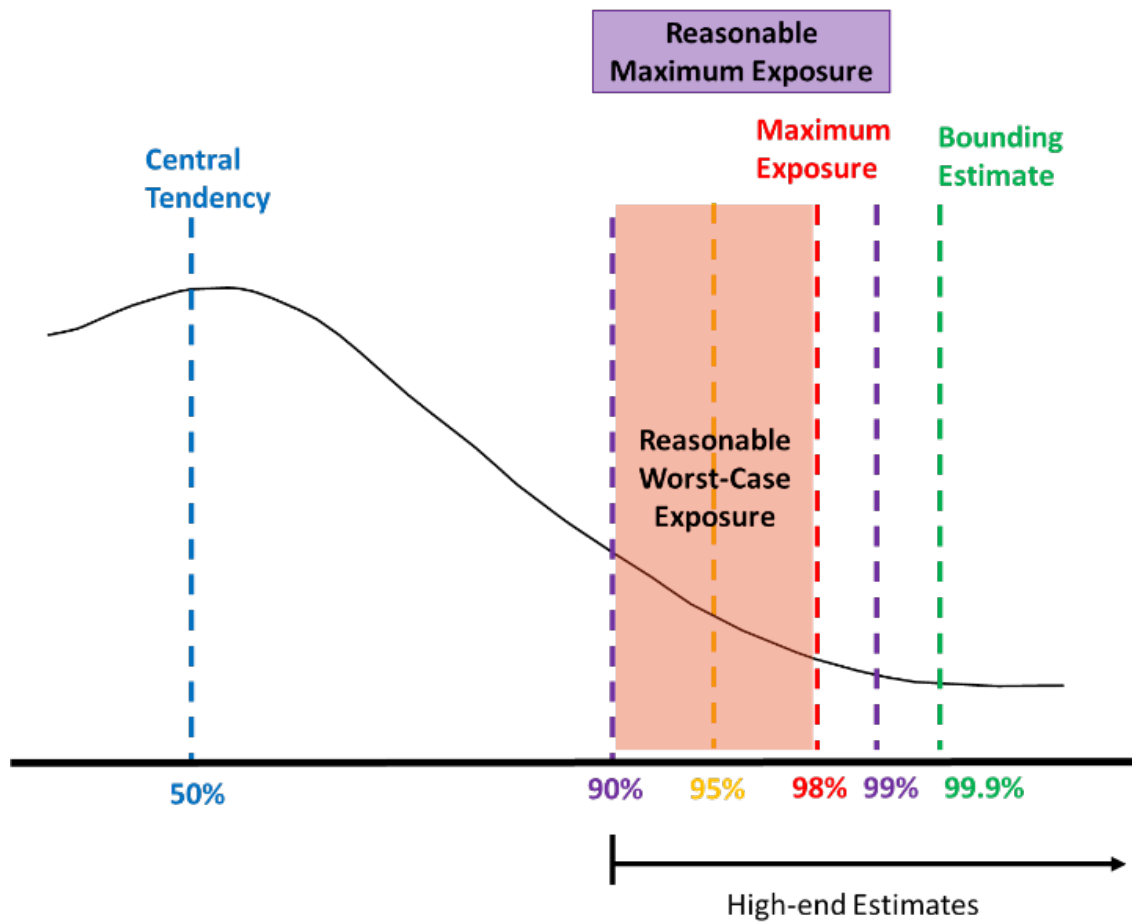

Figure 3.1: Estimated probabilistic chronic daily intake scenarios.

Input and Reference Values. We made the following assumptions for oral exposure to calculate CDI: IR of 2 L/day for an adult, EF is 365 days/year, ED of 70 years, LT of 70 years, male BW of 70 kg, female BW of 55 kg, child bodyweight of 15 kg and infant bodyweight of 5 kg (USEPA, 1992) (Table 3.1). The pre-implementation concentration of arsenic (C) was obtained from data from the CWS and the average concentration in treated water was used in CDI calculations.

Table 3.1: Assumptions for CDI calculation (USEPA, 1992).

Parameter	Deterministic Value	Probabilistic Values
Concentration (C)	Based on water quality data from each community water system	Lognormal distribution of concentrations from the water quality data from each community water system
Intake Rate (IR)	2 L/day	Normal distribution of 1000 randomly generated values with a mean at the deterministic values
Exposure Frequency (EF)	365 days/year	
Exposure Duration (ED)	Time to implement: CDI calculation: 70 years ADD calculation: variable	
Average Lifetime (AT)	70 years	
Bodyweight (BW)	Male = 70 kg Female = 55 kg Child = 15 kg Infant = 5 kg	

To determine post-intervention concentrations, we multiplied the pre-implementation concentration by the removal rate associated with a specific alternative. For example, if a POU manufacturer’s manual or guide specified the POU device is certified to reliably remove 80% of arsenic up to 40,000 bed volumes (and under specific source water pH conditions), we found the post-implementation concentration by multiplying 0.2 (1-0.80) by the pre-implementation concentration. Table 3.2 presents the identified removal rates associated with both centralized treatment improvements and POU/POE devices. Removal rates for centralized treatment technologies were identified by examining the EPA Arsenic Demo Reports and EPA Design Manuals for removal of arsenic or nitrate (USEPA, n.d., USEPA, 1978, USEPA, 2003a, USEPA, 2003b, USEPA, 2006a). Removal rates for POU/POE devices were found by consulting their performance data or contacting device manufacturers or distributors to verify removal rates.

Table 3.2: Contaminant removal rates for selected alternatives (USEPA, n.d., USEPA, 1978, USEPA, 2003a, USEPA, 2003b, USEPA, 2006a)

Region	Contaminant	Alternative	Technology	Removal Rate	Source of Information
1	Arsenic	Centralized upgrade	GFH Adsorptive Media Filtration	95%	Literature: USEPA (n.d.). Arsenic Mitigation Strategies.
		POU – Company B, Device B2	Adsorptive Media (Carbon fiber)	96% at pH = 8.5 99% at pH = 6.5	Device performance specifications
		POU Device D	Reverse Osmosis	97% as pentavalent Arsenic	Device performance specifications
5	Arsenic	Centralized	Pre-oxidation/ Filtration	80%	Literature: USEPA (n.d.). Arsenic Mitigation Strategies
		POE Device N	Adsorptive Media (GFH)	95% at pH = 7.5	Conversation with device distributor ¹
		POE Device K	Adsorptive Media (GFH)	97% removal of total arsenic	Conversation with device distributor ²
7	Nitrate	Centralized	Anion Exchange	90% removal of nitrate	Literature: DeSilva, 2003
		POU Device D	Reverse Osmosis	70% as N, 86% removal of nitrate-nitrite	Device performance specifications
		POU Device G	Reverse Osmosis	80%	Conversation with device distributor ¹
9	Arsenic	Centralized	Anion Exchange	95% removal of total arsenic	Literature: USEPA (n.d.). Arsenic Mitigation Strategies.
		POU Device B	Adsorptive Media (Carbon fiber)	96% at pH = 8.5 99% at pH = 6.5	Device performance specifications
		POU Device D	Reverse Osmosis	97% as pentavalent Arsenic	Device performance specifications

¹Information made available upon request, but not publicly available

²The company is currently redoing their website information on this product as it has been updated and no written information is currently available

Previous studies of POU/POE devices have shown the nominal removal rate associated with devices may not accurately represent the actual performance of a POU/POE device in operation over time (AWWARF, 2005). To incorporate suboptimal operational removal rates, we identified the following studies (Table 3.3) through a literature review of studies or projects that examined POU/POE devices for the removal of arsenic or nitrate from drinking water (AWWARF, 2005). Additional removal rates from literature can be found in Appendix C, Table C2, C3 and C4 from several different studies (AWWARF, 2005, Yang et.al., 2020). We used the removal rates in Appendix C to generate a “best case” contaminant removal scenario (high removal rate) and a “worst case” contaminant removal scenario (low removal rate). We then calculated post-treatment implementation values using both the best-and worst-case removal rates to provide a range of expected exposure for each exposure route.

Best-case, worst-case and actual removal rates for both centralized treatment upgrades and POU/POE devices are in Table 3.3. Notably, the best-case and worst-case scenarios are derived only from literature values and represent removal rates from field testing of POU/POE devices. Our selected POU/POE devices have removal rates from manufacturers that may be greater or less than the values provided in literature based on manufacturer and third-party testing and certification claims. For example, in Region 1, Device B has an arsenic removal rate claim of 99%, which is higher than the best-case removal rate found from literature (96%). Since we did not test POU/POE devices in field, we used the manufacturer’s removal rate to calculate the “actual” removal rate of a contaminant under ideal conditions. The best-case and worst-case scenarios from literature are used to provide a model for understanding the impact of potential variations in performance in field settings. As a result, we include best-case scenarios (those where the device performed at or close to manufacturer removal claims) and worst-case scenarios (those where the device underperformed compared to the manufacturer’s claims) to ensure our analysis does not under- or overestimate exposure.

Table 3.3: Selected centralized and POU/POE alternative removal rates and best-case and worst-case scenarios based on removal rates from literature used to model exposure in each CWS.

Region	Mean Contaminant Concentration in treated water pre-implementation	Scenario (Centralized Upgrade (C) or POU/POE Device (D))	Contaminant Removal Rate	Mean Contaminant Concentration in treated water post-implementation	Source of Information
1	8.3 µg/L of arsenic	C, selected	95%	0.42 µg/L	Literature: USEPA (n.d.). Arsenic Mitigation Strategies
		C, best-case	95%	0.42 µg/L	Literature: USEPA (n.d.). Arsenic Mitigation Strategies
		C, worst-case	74%	2.2 µg/L	Arsenic Demo Reports
		POU Device B, selected	99%	0.08 µg/L	Manufacturer specifications
		POU Device D, selected	97%	0.27 µg/L	Manufacturer specifications
		POU, best-case (Carbon fiber adsorptive media and RO)	96%	0.33 µg/L	AWWARF Report 2005
		POU, worst-case (Carbon fiber adsorptive media)	68%	6.6 µg/L	Powers et.al., 2019
		POU, worst-case, (Reverse osmosis)	46%	4.5 µg/L	AWWARF Report 2005
5	9.1 µg/L of arsenic	C, selected	80%	1.8 µg/L	Literature: USEPA (n.d.). Arsenic Mitigation Strategies
		C, best-case	80%	1.8 µg/L	Literature: USEPA (n.d.). Arsenic Mitigation Strategies
		C, worst-case	79%	1.9 µg/L	Arsenic Demo Reports
		POE Device N, selected	95%	0.46 µg/L	Manufacturer specifications
		POE Device K, selected	98%	0.18 µg/L	Manufacturer specifications
		POE, best-case	96%	0.37 µg/L	AWWARF Report 2005
		POE, worst-case	42%	5.3 µg/L	AWWARF Report 2005
7	9.3 mg/L of nitrate as N	C, selected	90%	0.94 mg/L	Literature: DeSilva, 2003
		C, best-case	90%	0.94 mg/L	Literature: DeSilva, 2003
		C, worst-case	65%	3.3 mg/L	Arsenic Demo Reports

		POU Device D, selected	80%	1.9 mg/L	Manufacturer specifications
		POU Device G, selected	70%	2.8 mg/L	Manufacturer specifications
		POU, best-case	97%	0.28 mg/L	Arsenic Demo Reports
		POU, worst-case	57%	4.0 mg/L	Arsenic Demo Reports
9	19.6 µg/L of arsenic	C, selected	95%	0.98 µg/L	Literature: USEPA (n.d.). Arsenic Mitigation Strategies
		C, best-case	95%	0.98 µg/L	Literature: USEPA (n.d.). Arsenic Mitigation Strategies
		C, worst-case	40%	11.8 µg/L	Arsenic Demo Reports
		POU Device B, selected	99%	0.2 µg/L	Manufacturer specifications
		POU Device D, selected	97%	0.59 µg/L	Manufacturer specifications
		POU, best-case (Carbon fiber adsorptive media and RO)	96%	0.78 µg/L	AWWARF Report 2005
		POU, worst-case (carbon fiber adsorptive media)	68%	15.7 µg/L	Powers et.al., 2019
		POU, worst-case (reverse osmosis)	46%	10.6 µg/L	AWWARF Report 2005

After completing calculations, we compared the CDI, carcinogenic risk, and MLE for both pre- and post-implementation values for each water system to the corresponding contaminant NOAEL and LOAEL values to determine if exposure to the contaminant is expected to result in observable adverse effects in the customer population. The CDI values for nitrate and uranium were compared only to the respective NOAEL and LOAEL values from literature as TCR and HQ cannot be calculated for these contaminants. Reference values from US EPA literature are in Table 3.4 (USEPA IRIS, 1989, USEPA IRIS, 1991, USEPA IRIS, 2021b). We adjusted the NOAEL and LOAEL values for arsenic for an intake of 2L/day and both a male bodyweight of 75 kg and a female bodyweight of 55 kg to align with the input values selected above.

Table 3.4: Reference literature values for each contaminant considered in the oral exposure route (USEPA IRIS, 1989, USEPA IRIS, 1991, USEPA IRIS, 2021b).

Contaminant	Reference Dose (RfD)	NOAEL	Adjusted NOAEL†				LOAEL	Oral Slope Factor	
			Units	Male (75 kg)	Female (55 kg)	Child (15 kg)			Infant (5 kg)
Arsenic*	0.3 µg/kg/day	0.8 ug/kg/day (0.009 mg/L)*	µg/kg/day	0.27	0.36	1.33	4.0	14.0 µg/kg/day (0.17 mg/L)*	1.5 per mg/kg/day
Nitrate	1.6 L/kg/day	1.6 mg/kg/day	mg/kg/day	0.27	0.36	1.33	4.0	1.8-3.2 mg/kg/day	NA
Uranium	3.0x10 ⁻³ mg/kg/day	NA	NA	NA	NA	NA	NA	2.8 mg/kg/day from food	NA

† Adjusted NOAEL values were calculated for an intake rate of 2L/day and the corresponding bodyweight

*NOAEL and LOAEL values are based on an intake rate of 4.5 L/day and a bodyweight of 75 kg

^based on 0.64 L/day for a 4 kg infant

Dermal exposure.

Calculations. Chronic daily intake for dermal exposure can be calculated using the following equation:

$$CDI = \frac{DA * SA * ED * EF}{BW * LT} \quad (3.6)$$

$$DA = K_p * C * t \quad (3.7)$$

In Equations 3.6 and 3.7, *DA* (mg/cm²-event) represents the dermal absorption dose, which is the product of the permeability coefficient *K_p* (cm/hr.), the concentration of the chemical contacting the skin *C* (mg/cm³) and the time per contact event *t* (hours/event). The variable *SA* (cm²) represents the skin area available for contact with the chemical (US EPA, 2020b).

Input values. Using the EPA Exposure Factors Handbook (US EPA, Chapter 7, 2011), we selected a surface area for the entire body (assuming dermal contact occurs during showering or bathing) of 210 cm² for an adult male, 180 cm² for an adult female, 160 cm² for a teenager and 50 cm² for an infant. A contact time per dose of 15 minutes was selected to calculate the dermal dose absorbed. Literature values for the permeability coefficient of arsenic were identified and a permeability coefficient of 2.7 x 10⁻³ was used for arsenite (As (III)) and a coefficient of 9.2 x 10⁻⁵ was used for arsenate (As (V)). No data detailing the ratio of As (III) to As (V) was available from Region 1, 5 or 9; therefore, we calculated exposure using both coefficients and reported the worst-case scenario estimates.

3.1.2 Estimating time to implement by modeling exposure duration

Calculations and inputs. Average daily dose (ADD) was used to model different exposure scenarios over an averaging time (AT) of 30 years (USEPA, 1992). ADD uses the same variables as the CDI calculation, but with an averaging time instead of a lifetime in the denominator. Using the same assumptions for CDI in Table 3.1, we modeled several exposure durations (ED) and concentrations (C) post-implementation. The following equations show the ADD calculation (Equation 3.8) and the relationships between pre- and post-implementation values (Equation 3.9 and 3.10)

$$ADD = \frac{C*IR*ED*EF}{BW*AT} \quad (3.8)$$

$$ADD_{total} = ADD_{pre} + ADD_{post} \quad (3.9)$$

$$ED_{pre} = 30 \text{ [years]} - ED_{post} \quad (3.10)$$

Using an averaging time of 30 years, we modeled ADD for pre-intervention and post-intervention doses, modeling ED values between 0-30 years for pre-implementation exposure. The ADD_{total} value was calculated as the sum of the ADD_{pre} value using an ED_{pre} value equal to $30 \text{ [years]} - ED_{post}$ and the ADD_{post} value equal to ED_{post} (Equation 3.10). Pre- and post-implementation concentrations were calculated as described above for CDI calculations. The pre- and post-intervention doses were then summed to determine the average daily dose over the averaging time of 30 years and compared to literature values to determine when the ADD exceeded the NOAEL or LOAEL for a given contaminant. If ADD_{total} exceeded the adjusted NOAEL value for the specific contaminant, we located the first ED_{pre} value where $ADD_{total} > NOAEL_{adjusted}$. This ED_{pre} value represents the maximum amount of time a CWS would have to implement the post-implementation solution (with a specific removal rate) before adverse effects are observable in a population. For example, if an intervention takes five years to implement, the pre-intervention dose is calculated using the pre-implementation concentration of the given contaminant over a five-year exposure duration, while the post-implementation dose was calculated using the post-implementation concentration (pre-implementation concentration multiplied by the removal rate) and a 25-year exposure duration. The aim of this analysis is to identify the first ED_{pre} value associated with each contaminant removal rate that exceeds the adjusted NOAEL to provide a maximum number of years a CWS will have to implement the specific alternative (Figure 3.2). Notably, this analysis is specific to a given removal rate and the initial contaminant concentration; the number of years to implement in practice depends on other water quality characteristics and contaminants in the system. For the purposes of this study, we focus specifically on each contaminant of concern in isolation when finding the ED_{pre} values for implementation timelines.

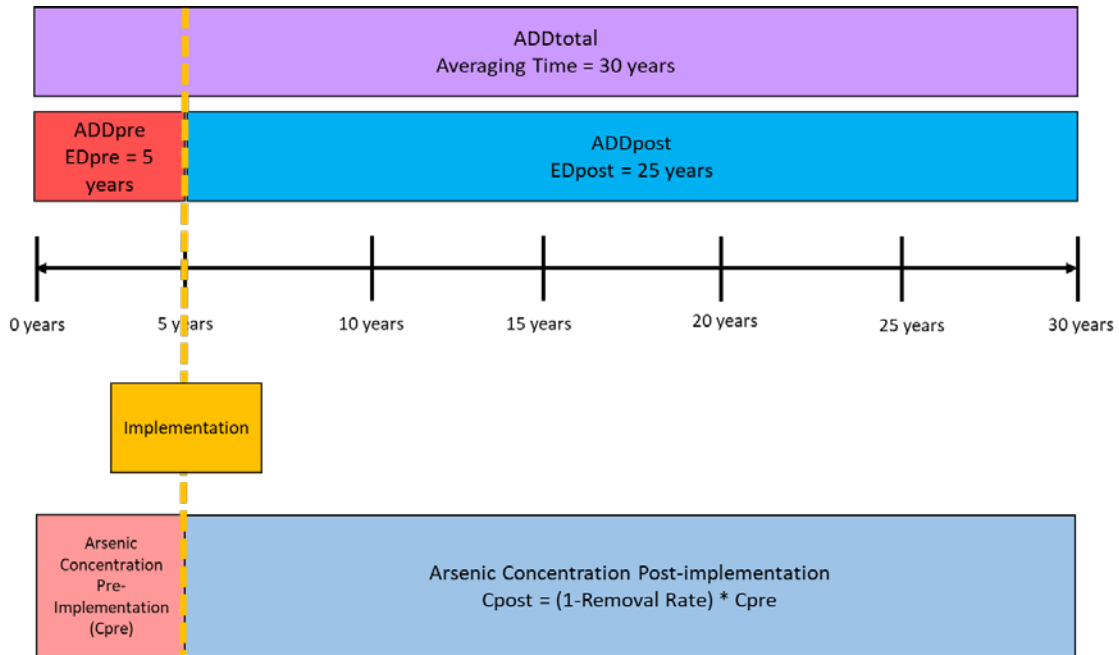

Figure 3.2: Method describing use of ADD over 30 years to determine the time to implement an alternative based on removal rate and exposure duration.

Comparing ADD values to timelines to implement

To put ADD_{total} values into context in each CWS, we consulted with CWS stakeholders and state administrators to construct timelines to realistically implement either a centralized treatment improvement or a POU/POE device. Activities included time to:

1. Obtain permits or state approval
2. Select and evaluate technologies
3. Secure funding for a system upgrade
4. Install a device or treatment improvement
5. Pilot studies prior to installation

Timelines were constructed for both a best-case (fastest time to implement) and worst-case scenarios (longer time to implement) to capture variations present in specific CWSs. We then compared the implementation timeline to the ED_{pre} values to determine whether an alternative can feasibly be implemented to reduce exposure. From these comparisons, it is then possible to make a judgement between the exposure associated with a POU/POE device and a centralized treatment improvement. It is important to note this analysis focuses primarily on the time necessary to implement a technology and the removal of a contaminant achieved by a technology. Operation and maintenance, including device replacement, is necessary to continue to assume the nominal removal rate remains the same over time; our analysis assumes consistent performance over time.

In addition, to use POU/POE units for compliance purposes, there must be a unit at each connection in a water system, meeting the “100% participation” requirement from the USEPA (USEPA, 2006b). CWS stakeholders interviewed for this project and information documented in literature have highlighted difficulties with obtaining 100% participation when considering POU/POE solutions which often can significantly delay POU/POE implementation in a CWS. In Region 9, California requirements have leniency wherein pilot testing may begin before 100% participation has been achieved, however, the requirement for 100% participation still has a significant impact on overall implementation timelines. As a result, when comparing the results of the ADD analysis described above to actual implementation, we compare two scenarios for POU/POE devices: (1) ideal implementation time as described by CWS stakeholders (best-case) and (2) worst-case implementation that includes an additional 3-5 years to achieve 100% participation before implementation can occur.

Estimating lifetime exposure

Finally, we adjusted our calculations of ADD and CDI to reflect lifetime exposure. While the study period is 30 years, calculating the average daily dose for an infant over a 30-year period does not represent the reality that an infant is considered a 0–2-year-old by USEPA exposure documentation (USEPA, 1992). Calculating 30 years of exposure for only an adult bodyweight does not account for the higher doses of a contaminant ingested by smaller bodyweight infants and children at the same contaminant concentration in water as adults consume. As a result, we examined exposure from 0-30 years using the following age ranges: 0-2 years old represents an infant, 2-10 years represents a child, and 10-30 years represents an adult (either female or male). We calculated both the ADD as described previously and the cumulative ADD to estimate 30 years of exposure from birth to 30 years old. We calculated lifetime exposure for a scenario where no improvement was implemented, where one of the two POU/POE devices was implemented, and where a centralized treatment improvement was implemented, and compared these values to the estimated implementation timelines. Dose was calculated per year to determine a cumulative dose from 0-30 years, representing the worst-case scenario of exposure in the CWSs.

3.2 Results

Results from individual calculations (including CDI, TCR and MLE) are presented in detail for only one case study CWS in the report as an example. Results from the three additional CWSs are presented in Appendix C.

3.2.1.1 Estimating intake of contaminants

3.2.1.1 Deterministic exposure

Oral exposure.

Table 3.6 shows the pre- and post-implementation exposure calculations for Region 1 using the identified removal rates (Table 3.2) to determine the final concentration of a contaminant in a water

system (similar tables for Regions 5, 7, and 9 are in Appendix C). Pre-implementation exposure to a mean arsenic concentration of 8.1 µg/L results in a carcinogenic risk greater than the NOAEL for all bodyweights evaluated if no treatment technology is implemented within the AT of 30 years. Pre-implementation, the HQ exceeds one for all bodyweights, indicating there is carcinogenic risk associated with exposure to arsenic.

Post-implementation, we found that for all treatment scenarios (best-case performance, actual device performance, etc.) evaluated in Region 1, the total carcinogenic risk values were less than the NOAEL (TCR < NOAEL) and HQ values were less than one (HQ < 1), except for the worst-case POU removal efficiency (20%). For this scenario, 20% removal would not adequately remove arsenic in the drinking water system to a level where there is no carcinogenic risk to the population (TCR > NOAEL or HQ > 1) over a 30-year exposure duration. Both the centralized treatment system improvement (95% removal) and the POU device alternatives (99% and 97% removal respectively) sufficiently reduce the total carcinogenic risk values below NOAEL values for arsenic, indicating that there is no evidence of carcinogenic risk. Table 3.5 presents these results, showing the mean arsenic concentration post-implementation (C_{post}), the CDI, TCR, HQ, and MLE values, including the MLE value translated into the number of people impacted per 10,000 people. CDI and TCR > NOAEL are highlighted in yellow and HQ > 1 is highlighted in red.

Table 3.5: Oral chronic daily intake exposure from arsenic in Region 1. Total carcinogenic risk values exceeding the adjusted NOAEL are highlighted in yellow and hazard quotient values greater than one are highlighted in red.

Scenario			Mean Arsenic Concentration (µg/L)	Bodyweight	CDI (ug/kg/day)	Carcinogenic Risk (ug/kg/day)	Hazard Quotient	MLE	# of People per 10,000 people
Pre-Implementation	Centralized	Treatment of 50% of the flow rate from the GW via adsorptive media filtration	8.3	Male = 75 kg	0.22	0.33	1.1	1.7E-05	1.7
				Female = 55 kg	0.30	0.45	1.5	2.3E-05	2.3
				Child = 15 kg	1.11	1.66	5.5	8.3E-05	8.3
				Infant = 5 kg	3.32	4.98	16.6	2.5E-04	24.9
Post-Implementation	Centralized Upgrade	Treatment of 100% of the flow rate by adding an additional filtration module (95% Removal)	0.42	Male = 75 kg	0.01	0.02	0.06	8.3E-07	0.1
				Female = 55 kg	0.02	0.02	0.08	1.1E-06	0.1
				Child = 15 kg	0.06	0.08	0.28	4.2E-06	0.4
				Infant = 5 kg	0.17	0.25	0.83	1.2E-05	1.2
	POU	POU Device B, Adsorptive Media (99% Removal)	0.08	Male = 75 kg	0.0022	0.00	0.01	1.7E-07	0.0
				Female = 55 kg	0.0030	0.00	0.02	2.3E-07	0.0
				Child = 15 kg	0.011	0.02	0.06	8.3E-07	0.1
				Infant = 5 kg	0.033	0.05	0.17	2.5E-06	0.2
	POU	POU Device D, Reverse Osmosis (97% Removal)	0.25	Male = 75 kg	0.0066	0.01	0.03	5.0E-07	0.0
				Female = 55 kg	0.0091	0.01	0.05	6.8E-07	0.1
				Child = 15 kg	0.0332	0.05	0.17	2.5E-06	0.2
				Infant = 5 kg	0.0996	0.15	0.50	7.5E-06	0.7

In Region 5, due to a higher pre-implementation arsenic concentration of 9.1 µg/L and a lower centralized treatment removal efficiency of 80% of arsenic (compared to Region 1), the calculated HQ values were >1 for specific bodyweights, indicating a risk of carcinogenic effects from arsenic in children and infants. The removal efficiency from POE Device N (95% of arsenic) and POE Device K (97% removal of total arsenic) produced TCR values less than the NOAEL and HQ < 1, indicating no carcinogenic risk from arsenic to the customers in the Region 5 CWS after a 30- year exposure duration. Deterministic results in Region 5 indicate higher removal efficiencies are preferable, with the POE devices adequately reducing exposure so that HQ < 1, minimizing carcinogenic risk.

In Region 7, we did not calculate TCR, HQ and MLE since nitrate is non-carcinogenic according to the USEPA IRIS database (USEPA, 2021b). Instead, we compared the CDI values to the NOAEL and LOAEL values for nitrate via oral exposure to determine any expected observable effects. Pre-implementation, no CDI values exceeded the NOAEL or LOAEL for nitrate, with the same result post-implementation as well. Deterministic results indicate that there was no difference in exposure from centralized or POU treatment since the pre-implementation concentration of nitrate was already below the NOAEL threshold.

In Region 9, due to a high mean pre-implementation arsenic concentration of 19.6 µg/L, our results indicated carcinogenic risk associated with all currently identified removal efficiencies, with the exception of 99% removal of arsenic by POU Device B. All but one upgrade option resulted in a HQ >1; however, POU Device B resulted in HQ<1 with a total carcinogenic risk < NOAEL. Carcinogenic risk associated with arsenic was calculated to be a concern particularly for infants, due to the smaller bodyweight of 5 kg. Deterministic results indicate that a high removal efficiency is necessary in Region 9 to sufficiently reduce exposure; the only option able to meet this requirement was POU Device B with a removal efficiency of 99%.

In Region 9, we also evaluated the risk associated with uranium exposure and the combined exposure to uranium and arsenic. There are no current NOAEL and LOAEL values for uranium associated in water, therefore, we compared CDI and TCR values to the reference dose for uranium. Deterministic results for uranium alone indicate the CDI value exceeds the reference dose for uranium pre-implementation. Pre-implementation, the TCR values exceed the reference dose for all bodyweights, with a HQ > 1 for infant bodyweights. Post-implementation, 50% removal of uranium would be sufficient so that a male person in a community will not have a CDI value greater than the reference dose, but the TCR and CDI values for a woman, child, and teen remain greater than the reference dose. When the removal rate is increased to 90-99% based on literature removal values for uranium, the CDI and TCR values would then be less than the reference dose and no HQ>1, indicating sufficient reduction in uranium exposure. These results indicate that POU/POE devices with higher removal efficiencies may be preferential in Region 9, particularly when reducing both arsenic and uranium concentrations to levels where adverse impacts are not seen in the population.

Initial results provide evidence that the higher removal efficiencies associated with POU/POE devices under best case circumstances may reduce total carcinogenic risk to the small CWSs considered in this study (Table 3.6). In the Regions 5 and 9 cases, the higher initial arsenic concentration corresponds with higher TCR and HQ values with resulting potential carcinogenic risk for these communities. In Region 7, because neither pre- nor post-implementation concentrations of nitrate resulted in CDI greater than the NOAEL for nitrate, there was no advantage of centralized or POU/POE treatment alternative based on lifetime oral exposure alone.

Table 3.6: Overall initial results indicating where carcinogenic risk is expected in at least one bodyweight category for arsenic contamination or where no observable adverse effects are present for nitrate contamination.

Scenario		Region 1	Region 5	Region 7	Region 9
Pre-Implementation	Centralized	Carcinogenic Risk	Carcinogenic Risk	No Observable Adverse Effects	Carcinogenic Risk
Post-Implementation	Centralized Upgrade	No Carcinogenic Risk	Carcinogenic Risk	No Observable Adverse Effects	Carcinogenic Risk
	POU/POE Device(Larger Removal Rate)	No Carcinogenic Risk	No Carcinogenic Risk	No Observable Adverse Effects	No Carcinogenic Risk
	POU/POE Device (Smaller Removal Rate)	Carcinogenic Risk	No Carcinogenic Risk	No Observable Adverse Effects	Carcinogenic Risk

Inhalation and Dermal Exposure.

After reviewing literature and completing initial calculations for both inhalation and dermal exposure, we determined the oral exposure route was the most significant source of exposure based on our

selected contaminants. We considered the inhalation and dermal exposure routes due to the possibility of inhalation of contaminated water at shower heads, a scenario that could occur if a POU device were installed, since a POU device only treats water at the tap where installed. Therefore, exposure risks would exist at pre-implementation contaminant concentrations (arsenic, nitrate or uranium) in Regions 1, 7 and 9. In contrast, a POE device, which treats all water prior to entering premise plumbing, would reduce inhalation and dermal exposure; in Region 5, POE devices were selected, and therefore dermal and inhalation exposure would rely on the post-implementation concentrations of a contaminant. Therefore, we considered exposure to pre-implementation concentrations via inhalation and dermal routes for all selected POU devices and exposure to post-implementation concentration via inhalation and dermal exposure for selected POE devices (Region 5) and centralized treatment improvements.

Inhalation and dermal exposure pathways for uranium are not in the EPA IRIS database, showing that exposure to these have not yet been evaluated through epidemiological studies and thus there is no reference data available to determine a NOAEL, LOAEL, reference dose, or potential carcinogenic risk of uranium via these exposure routes (USEPA IRIS, 1989). Exposure to nitrate via the inhalation and dermal route is not considered significant compared to nitrate exposure via food consumption and through the oral exposure to drinking water (USEPA IRIS, 2021b). Arsenic can cause potential carcinogenic and non-carcinogenic effects in humans via the dermal and inhalation routes (USEPA IRIS, 1991). Based on this information, we conducted an exploratory analysis of exposure via dermal and inhalation routes to assess the magnitude of exposure in comparison to the oral exposure route. *Inhalation exposure.* While studies have shown inhalation of arsenic to be detrimental to human health, exposure to arsenic through inhalation is primarily through air as a media (dust particles), rather than water (USEPA, 1991). Few, if any studies have examined exposure to inorganic contaminants such as arsenic via inhalation of aerosolized water droplets. Studies examining exposure to contaminants in aerosolized water droplets in household showers have largely focused on microbial contamination (e.g., *Legionella*) or from volatile organic contaminants (Azuma et.al., 2013, Zhou et.al., 2011). To estimate arsenic exposure via aerosolized water droplets, we first attempted to determine the concentration of arsenic in water droplets using the equations in Davis et.al. 2016. However, these calculations rely on knowledge of the fraction volume of water droplets inhaled, the water volume aerosolization rate per shower fixture, the flow rate of water at a shower fixture, the breathing rate of a person, and the arsenic specific fraction aerosolized. While several of these values can be estimated via literature, no studies have been conducted to determine how much arsenic in water is aerosolized in a shower, leading to a large degree of uncertainty in the concentration of arsenic inhaled by an average person during a bathing event.

Furthermore, even if the arsenic concentration in aerosolized water particles could be estimated, USEPA IRIS studies have only investigated the risk of exposure to arsenic via the inhalation in air (not in aerosolized water droplets). Therefore, any reference values provided by the IRIS database are not applicable to our scenario (USEPA, 1989). In addition, once arsenic in aerosolized droplets is inhaled,

only a fraction of the arsenic concentration is absorbed by lung tissue and has the potential to cause carcinogenic or non-carcinogenic effects (USEPA, 2020a). While the inhalation pathway is important for microbial and volatile organic contaminants, we did not find sufficient guidance to perform a reasonable calculation of inhalation exposure for the inorganic contaminants such as arsenic, nitrate and uranium, nor evidence to suggest that these are important routes of exposure to these contaminants relative to ingestion of drinking water.

Dermal exposure. We did, however, find evidence from literature that dermal exposure to arsenic is an important exposure route to include in our analysis (Boffetta et.al., 2020). For dermal exposure, we determined it would be necessary to calculate exposure to arsenite (As(III)) and arsenate (As(V)) separately as each compound has a different permeability coefficient. Since we lack arsenic speciation from Region 1, 5, or 9, we assumed a worst-case scenario for each species, using the total arsenic pre-implementation concentration to calculate the dermal concentration absorbed in $\mu\text{g}/\text{cm}^2$. Initial calculations indicate the exposure to arsenic via the dermal route is 2 orders of magnitude smaller than through the oral exposure route for Region 1 and does not pose a carcinogenic risk.

An example of dermal exposure to arsenite (As (III)) and arsenate (As (V)) are in Appendix C. Dermal exposure values (CDI, TCR and HQ) were calculated separately for arsenite and arsenate because each compound has a different permeability coefficient. We calculated exposure parameters assuming that 100% of arsenic in Region 1 was either arsenite or arsenate to generate worst-case exposure scenarios. Dermal exposure results are not discussed in detail in the results of this report, but calculated values are provided in Appendix C for completeness.

3.2.1.2 Probabilistic exposure

Oral exposure.

Table 3.7 provides the results of probabilistic modeling of chronic daily intake for Region 1. For all considered removal efficiencies, the central tendency estimate (median) does not exceed the NOAEL. However, reasonable worst case exposure values (90th-98th percentiles) indicate the CDI values exceed the NOAEL values both in the pre-implementation scenario and when using the worst-case exposure POU scenario (68% removal of arsenic). For removal efficiencies of 95% (centralized treatment), 96% (best-case POU treatment from literature) and 99% (POU Device B), the 90th percentile values for CDI do not exceed the NOAEL, indicating any of these removal efficiencies are sufficient to reduce arsenic exposure below the NOAEL. The probabilistic modeling results verify the conclusions made from the deterministic analysis presented previously for Region 1, indicating higher removal rates are preferable for reducing contaminant exposure.

Table 3.7: Probabilistic chronic daily intake results for Region 1 exposure showing percentiles of interest related to exposure

Pre-implementation							
	Bodyweight*	Central Tendency	Reasonable Worst- Case Exposure (Lower Bound)	95th Percentile	Maximum Exposure	Maximum Exposure (Upper Bound)	Bounding Estimate
	Male	0.120	0.233	0.277	0.291	0.294	0.301
	Female	0.150	0.289	0.347	0.351	0.360	0.377
Post-implementation							
Removal Rate							
95% Removal	Male	0.011	0.015	0.016	0.017	0.017	0.019
	Female	0.015	0.020	0.021	0.023	0.024	0.027
	Child	0.056	0.074	0.079	0.084	0.087	0.096
	Infant	0.169	0.229	0.248	0.269	0.287	0.319
96% Removal	Male	0.009	0.012	0.013	0.014	0.014	0.015
	Female	0.012	0.016	0.017	0.018	0.019	0.021
	Child	0.045	0.059	0.063	0.067	0.070	0.077
	Infant	0.135	0.183	0.198	0.215	0.230	0.256
99% Removal	Male	0.002	0.003	0.003	0.003	0.003	0.004
	Female	0.003	0.004	0.004	0.005	0.005	0.005
	Child	0.011	0.015	0.016	0.017	0.017	0.019
	Infant	0.034	0.046	0.050	0.054	0.057	0.064

*Male bodyweight = 75 kg, Female bodyweight = 55 kg, Child bodyweight – 15 kg, and infant bodyweight = 5kg

Probabilistic results for Regions 5, 7 and 9 are presented in Appendix C. Results from the probabilistic modeling verify the results obtained via deterministic calculations.

3.2.2 Estimating time to implement by modeling exposure duration

Table 3.8 provides a summary of both the total carcinogenic risk and HQ values for a number of years (0-30 years) to implement an alternative in Region 1. The table compares the TCR and HQ values for a male bodyweight and an infant bodyweight to highlight the importance of both bodyweight and removal efficiency. The number of years to implement represents the ED pre-implementation value used to calculate ADD during modeling.

In Region 1, TCR values for a worst-case 68% arsenic removal efficiency and a male bodyweight does exceed the NOAEL for arsenic. This indicates that if a POU device with a low removal efficiency was implemented today, the male population in Region 1 would not be at risk for carcinogenic effects. With actual device removal efficiencies between 95-99%, TCR values do not exceed the NOAEL until 24 years of pre-implementation exposure. This indicates a male population in Region 1 would not expect to see carcinogenic effects from the combined pre-implementation concentrations of arsenic (8.3 µg/L) and post-implementation concentrations of arsenic (0.08-0.42 µg/L) until year 24. Recall TCR is evaluated using the total average daily dose values over 30 years multiplied by the reference dose for arsenic. This means the male population in Region 1 will cross the threshold from non-carcinogenic risk to carcinogenic risk (TCR > NOAEL) when the maximum pre-implementation concentration is 8.3 µg/L for 24 years, and a post-implementation concentration is 0.08-0.42 µg/L for 6 years. From an implementation standpoint, if the removal is 95-99%, the system has 24 years in which to implement the technologies with a 95-99% removal efficiency before carcinogenic risk is present in the male population. If an alternative is implemented after 24 years, the average daily dose experienced by the male population yields a TCR value > NOAEL because the population has been exposed to the pre-implementation concentration for too long compared to exposure to post-implementation concentrations. If we examine the TCR values for an infant, a child, and a female bodyweight, we see similar results.

However, if we examine HQ instead of TCR, we discover that for an infant bodyweight, the number of years available to implement a treatment technology decreased. In Table 3.8, scenarios where the HQ>1 are highlighted in red, representing scenarios with carcinogenic risk present to a given population. For removal rates of 95% (centralized treatment) and 97% (POU Device D), only one year can pass pre-implementation before reaching HQ>1 for an infant bodyweight. POU Device B with a removal efficiency of 99% has HQ >1 after two years of pre-implementation exposure. Either the centralized treatment upgrade or POU Device D would need to be implemented within one year to prevent total exposure over a 30-year period from causing carcinogenic effects. POU Device D, having a higher removal rate, needs to be implemented within 2 years to minimize carcinogenic risk for infants.

Table 3.8: Region 1 ADD values for POU AM technologies (Device B) and centralized improvements with several different removal rates for arsenic for male and infant bodyweights.

Number of years to implement	Male										Infant									
	Total Carcinogenic Risk (ug/kg/day)					Hazard Quotient					Total Carcinogenic Risk (ug/kg/day)					Hazard Quotient				
	Removal Rate					Removal Rate					Removal Rate					Removal Rate				
	Centralized (95%)	POU Device B (99%)	POU Device D (97%)	Best Case POU (96%)	Worst Case POU (68%)	Centralized (95%)	POU Device B (99%)	POU Device D (97%)	Best Case POU (96%)	Worst Case POU (268%)	Centralized (95%)	POU Device B (99%)	POU Device D (97%)	Best Case POU (96%)	Worst Case POU (68%)	Centralized (95%)	POU Device B (99%)	POU Device D (97%)	Best Case POU (96%)	Worst Case POU (68%)
0	0.02	0.00	0.01	0.01	0.25	0.1	0.0	0.0	0.0	0.4	0.25	0.05	0.15	0.20	1.59	0.8	0.2	0.5	0.7	5.3
1	0.03	0.01	0.02	0.02	0.27	0.1	0.0	0.1	0.1	0.4	0.41	0.21	0.31	0.36	1.71	1.4	0.7	1.0	1.2	5.7
2	0.04	0.03	0.03	0.03	0.29	0.1	0.1	0.1	0.1	0.4	0.56	0.38	0.47	0.52	1.82	1.9	1.3	1.6	1.7	6.1
3	0.05	0.04	0.04	0.05	0.30	0.2	0.1	0.1	0.2	0.4	0.72	0.54	0.63	0.68	1.93	2.4	1.8	2.1	2.3	6.4
4	0.06	0.05	0.05	0.06	0.32	0.2	0.2	0.2	0.2	0.5	0.88	0.71	0.79	0.84	2.05	2.9	2.4	2.6	2.8	6.8
5	0.07	0.06	0.06	0.07	0.34	0.2	0.2	0.2	0.2	0.5	1.04	0.87	0.95	1.00	2.16	3.5	2.9	3.2	3.3	7.2
6	0.08	0.07	0.07	0.08	0.36	0.3	0.2	0.2	0.3	0.5	1.20	1.04	1.12	1.16	2.27	4.0	3.5	3.7	3.9	7.6
7	0.09	0.08	0.09	0.09	0.38	0.3	0.3	0.3	0.3	0.5	1.35	1.20	1.28	1.31	2.38	4.5	4.0	4.3	4.4	7.9
8	0.10	0.09	0.10	0.10	0.39	0.3	0.3	0.3	0.3	0.6	1.51	1.36	1.44	1.47	2.50	5.0	4.5	4.8	4.9	8.3
9	0.11	0.10	0.11	0.11	0.41	0.4	0.3	0.4	0.4	0.6	1.67	1.53	1.60	1.63	2.61	5.6	5.1	5.3	5.4	8.7
10	0.12	0.11	0.12	0.12	0.43	0.4	0.4	0.4	0.4	0.6	1.83	1.69	1.76	1.79	2.72	6.1	5.6	5.9	6.0	9.1
11	0.13	0.12	0.13	0.13	0.45	0.4	0.4	0.4	0.4	0.6	1.98	1.86	1.92	1.95	2.84	6.6	6.2	6.4	6.5	9.5
12	0.14	0.13	0.14	0.14	0.46	0.5	0.4	0.5	0.5	0.7	2.14	2.02	2.08	2.11	2.95	7.1	6.7	6.9	7.0	9.8
13	0.15	0.15	0.15	0.15	0.48	0.5	0.5	0.5	0.5	0.7	2.30	2.19	2.24	2.27	3.06	7.7	7.3	7.5	7.6	10.2
14	0.16	0.16	0.16	0.16	0.50	0.5	0.5	0.5	0.5	0.7	2.46	2.35	2.40	2.43	3.17	8.2	7.8	8.0	8.1	10.6
15	0.17	0.17	0.17	0.17	0.52	0.6	0.6	0.6	0.6	0.7	2.61	2.51	2.56	2.59	3.29	8.7	8.4	8.5	8.6	11.0
16	0.18	0.18	0.18	0.18	0.54	0.6	0.6	0.6	0.6	0.8	2.77	2.68	2.73	2.75	3.40	9.2	8.9	9.1	9.2	11.3

17	0.20	0.19	0.19	0.19	0.55	0.7	0.6	0.6	0.6	0.8	2.93	2.84	2.89	2.91	3.51	9.8	9.5	9.6	9.7	11.7
18	0.21	0.20	0.20	0.20	0.57	0.7	0.7	0.7	0.7	0.8	3.09	3.01	3.05	3.07	3.63	10.3	10.0	10.2	10.2	12.1
19	0.22	0.21	0.21	0.22	0.59	0.7	0.7	0.7	0.7	0.8	3.25	3.17	3.21	3.23	3.74	10.8	10.6	10.7	10.8	12.5
20	0.23	0.22	0.22	0.23	0.61	0.8	0.7	0.7	0.8	0.9	3.40	3.34	3.37	3.39	3.85	11.3	11.1	11.2	11.3	12.8
21	0.24	0.23	0.24	0.24	0.62	0.8	0.8	0.8	0.8	0.9	3.56	3.50	3.53	3.55	3.96	11.9	11.7	11.8	11.8	13.2
22	0.25	0.24	0.25	0.25	0.64	0.8	0.8	0.8	0.8	0.9	3.72	3.67	3.69	3.71	4.08	12.4	12.2	12.3	12.4	13.6
23	0.26	0.26	0.26	0.26	0.66	0.9	0.9	0.9	0.9	0.9	3.88	3.83	3.85	3.86	4.19	12.9	12.8	12.8	12.9	14.0
24	0.27	0.27	0.27	0.27	0.68	0.9	0.9	0.9	0.9	1.0	4.03	3.99	4.01	4.02	4.30	13.4	13.3	13.4	13.4	14.3
25	0.28	0.28	0.28	0.28	0.70	0.9	0.9	0.9	0.9	1.0	4.19	4.16	4.17	4.18	4.42	14.0	13.9	13.9	13.9	14.7
26	0.29	0.29	0.29	0.29	0.71	1.0	1.0	1.0	1.0	1.0	4.35	4.32	4.34	4.34	4.53	14.5	14.4	14.5	14.5	15.1
27	0.30	0.30	0.30	0.30	0.73	1.0	1.0	1.0	1.0	1.0	4.51	4.49	4.50	4.50	4.64	15.0	15.0	15.0	15.0	15.5
28	0.31	0.31	0.31	0.31	0.75	1.0	1.0	1.0	1.0	1.1	4.66	4.65	4.66	4.66	4.75	15.5	15.5	15.5	15.5	15.8
29	0.32	0.32	0.32	0.32	0.77	1.1	1.1	1.1	1.1	1.1	4.82	4.82	4.82	4.82	4.87	16.1	16.1	16.1	16.1	16.2
30	0.33	0.33	0.33	0.33	0.78	1.1	1.1	1.1	1.1	1.1	4.98	4.98	4.98	4.98	4.98	16.6	16.6	16.6	16.6	16.6

The results from Table 3.8 reveal the importance of incorporating the removal efficiencies. As the removal efficiency increases, a population can be exposed to a pre-implementation concentration for longer without either the TCR>NOAEL or the HQ >1. Technologies offering higher removal efficiencies will have longer possible implementation timelines before carcinogenic risk from arsenic is a concern in the water system.

The pre-implementation contaminant concentration is also critical. Results from Region 5 (pre-implementation mean arsenic concentration of 9.1 µg/L) and Region 9 (pre-implementation mean arsenic concentration of 19.6 µg/L) would need to implement technologies sooner to minimize potential health effects even if the technologies offered the same removal rates as Region 1. In Region 5, centralized treatment with an arsenic removal rate of 80% would need to be implemented within 20 years for male and female populations (Table 3.8), but because the pre-implementation concentration is higher than Region 1 and the removal efficiency is smaller, even if the centralized treatment system were implemented today (0 years) there would still be a carcinogenic risk associated with arsenic exposure. However, if POE Device N (arsenic removal rate of 95%) were implemented, there would be 1 year for infants and 4 years for children before we expect carcinogenic effects.

Table 3.9 provides a summary of the number of years to implement an alternative in each Region.

Table 3.9: Summary of the of the time to implement alternatives for different removal rates. The time to implement was estimated using both the total carcinogenic risk and the hazard quotient for systems with arsenic contamination (EPA Regions 1, 5 and 9). In Region 7, we present the total ADD values in the TCR column for completeness.

EPA Region	Removal Rate	Male		Female		Child		Infant	
		Time to Implement (years)		Time to Implement (years)		Time to Implement (years)		Time to Implement (years)	
		Based on Total Carcinogenic Risk > NOAEL	Based on Hazard Quotient > 1	Based on Total Carcinogenic Risk > NOAEL	Based on Hazard Quotient > 1	Based on Total Carcinogenic Risk > NOAEL	Based on Hazard Quotient > 1	Based on Total Carcinogenic Risk > NOAEL	Based on Hazard Quotient > 1
1	Centralized Treatment Upgrade (95%)	24	26	24	20	24	5	24	1
	POU, Device B, Adsorptive Media (99%)	24	26	24	20	24	6	25	2
	POU, Device D, RO (97%)	24	26	24	20	24	5	24	1
5	Centralized Treatment Upgrade (80%)	20	22	20	15	20	0	20	0
	POE, Device K, Adsorptive Media (98%)	22	24	22	18	22	5	1	2
	POE, Device N, Adsorptive Media (95%)	22	23	22	18	22	4	22	1
7	Centralized Treatment Upgrade (90%)	20	23	20	16	20	2	20	0
	POU, Device D, RO (70%)	18	21	18	12	17	0	17	0

	POU, Device G, RO (80%)	19	22	19	14	19	0	19	0
9	Centralized Treatment Upgrade (95%)	10	11	10	8	10	1	10	0
	POU, Device B, Adsorptive Media (99%)	11	12	10	9	10	3	11	1
	POU, Device D, RO (97%)	10	11	10	8	10	2	10	0

***Values represent the total ADD over 30 years for nitrate as nitrate is currently classified as non-carcinogenic**

We gathered data from CWS stakeholders to determine time to implement the new treatment (centralized or POU/POE) to compare with the exposure assessment results. Stakeholders included state drinking water department administrators, community water system operators and managers, and engineering consultants who had worked with CWS on system improvements. Figure 3.3 below presents data from Region 1 comparing the necessary time expected to implement either a centralized improvement or a POU/POE. Improvements to the centralized system were estimated to take 3-5 years to implement (including obtaining permits, applying for funding, selecting the improvement, piloting the improvement and installing the improvement). In comparison, POU/POE devices would be expected to have a shorter implementation time of 2-4 years, provided there is 100% participation in the POU/POE program (a concern noted earlier). However, the time to approve adoption of a POU/POE compliance strategy by securing 100% participation can extend the time it takes to approve and install a POU/POE option. Overall, we estimated the worst-case scenarios of as 5.25 years to install a centralized treatment option and 4.25 years to install POU/POEs.

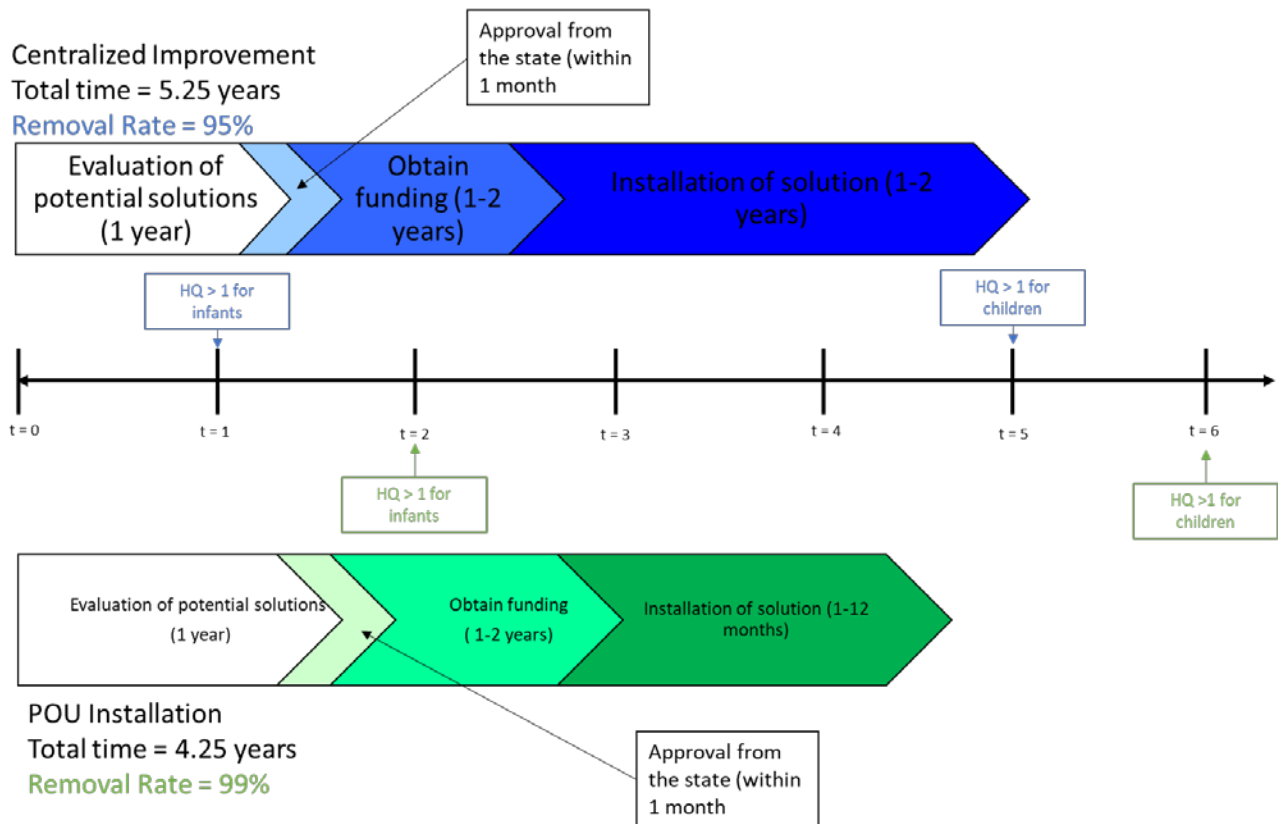

Figure 3.3: Timeline of worst-case installation estimates for alternatives including the time at which the ADD values exceed the NOAEL values for a given removal efficiency in Region 1 based on feedback from Region 1 stakeholders.

We then superimposed our results from evaluating TCR and HQ onto the timelines (Figure 3.3). In Region 1, we determined that after one year, the HQ >1 for infants with a centralized treatment removal rate of 95%, and the HQ >1 after two years for POU Device B with a removal rate of 99%. We found HQ >1 for children at 5 years for the centralized treatment removal rate of 95% and the HQ >1 at 6 years for POU Device B with a removal rate of 99%. This analysis suggests that installation of POU Device B can take several years and still be protective of human health when compared to centralized treatment. While a carcinogenic risk in the infant population would be observed before POU Device B is completely implemented, the HQ <1 for children within the 4-5 years it would take for POU to be implemented while for centralized treatment, the timeline to implement is longer and the HQ >1 for children within this timeline. Provided POU Device B truly does achieved 99% removal of arsenic, this device would allow the CWS in Region 1 more time to complete the necessary treatment upgrade installation timeline while minimizing carcinogenic risk to younger and more vulnerable populations.

The centralized upgrade and POU/POE implementation timelines for Regions 5, 7 and 9 are in Appendix C, Figures C1-3. In Region 9, sampling activities are included in the implementation timeline

because California allows a pilot to be completed prior to 100% participation. Table 3.10 provides a summary of the results of modeling time to implement each alternative in all four regions. Entries in the table are marked “before” if the combination of removal rate and bodyweight resulted in HQ>1 prior to completing the full implementation timeline of the alternative. Entries in the table are marked “after” if the combination of removal efficiency and bodyweight result in HQ>1 after an alternative has been fully implemented.

Table 3.10: Summary of time to implement for each alternative. Entries in the table are marked “before” if the combination of removal rate and bodyweight result in HQ>1 prior to full implementation of the alternative and “after” if the combination of removal efficiency and bodyweight result in a HQ>1 after an alternative has been fully implemented.

Region	Bodyweight	Centralized Treatment Upgrade			POU/POE Devices			
		Actual	Best-case	Worst-case	Device (Higher removal)	Device (Smaller Removal)	Best-case	Worst-case
1	Infant	Before	Before	Before	Before	Before	Before	Before
	Child	Before	Before	Before	After	After	Before	Before
	Female	After	After	After	After	After	After	Before
	Male	After	After	After	After	After	After	After
5	Infant	Before	Before	Before	Before	Before	Before	Before
	Child	Before	Before	Before	Before	Before	Before	Before
	Female	After	After	After	After	After	After	Before
	Male	After	After	After	After	After	After	After
7	Infant	Before	Before	Before	Before	Before	Before	Before
	Child	Before	Before	Before	Before	Before	Before	Before
	Female	After	After	After	After	After	After	After
	Male	After	After	After	After	After	After	After
9	Infant	Before	Before	Before	Before	Before	Before	Before
	Child	Before	Before	Before	Before	Before	Before	Before
	Female	After	After	Before	After	After	After	Before
	Male	After	After	Before	After	After	After	Before

The following figure presents each centralized or POU/POE alternative selected for each CWS and compares the worst-case implementation timeline (shown in orange in each panel) to the number of years (from Table 3.10) before the HQ>1. The numeric values presented on the graph represent the number of years when the HQ first exceeds 1, indicating the new treatment system is no longer reducing human exposure below an acceptable threshold for the given contaminant. The HQ values are shown as vertical lines based on the ADD calculations. The values are then compared to the number of years (worst-case scenario) to implement each treatment type in each CWS (explained earlier). If the number of years to implement any treatment upgrade is greater than the first year where the HQ value exceeds one, then the alternative falls in a region shaded blue to represent the fact that this scenario does not adequately reduce exposure to a given contaminant within the worst-case timeline. We have included both the ideal implementation timeline (solid blue) and a worst-case scenario (dotted blue line) to represent an additional 5 years of time to give time to achieve 100% community participation (dotted blue line). If the blue bar passes any of the vertical lines moving from left to right, then we expect to see adverse effects in the community population because an alternative has not been implemented early enough to reduce arsenic or nitrate exposure.

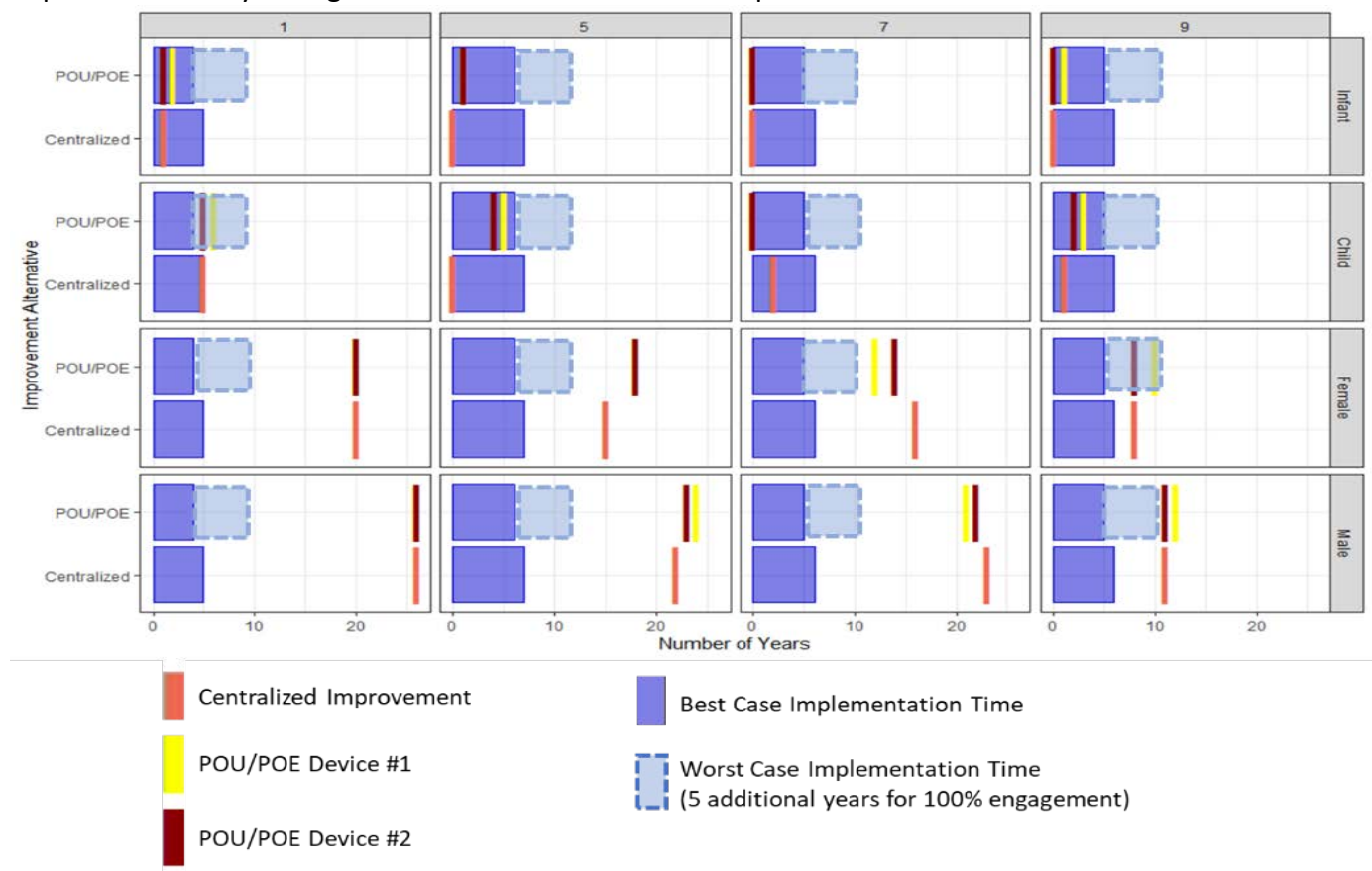

Figure 3.4: Summary of the number of years before the HQ>1 compared to the worst-case implementation timeline as identified by CWS stakeholders.

3.2.3 Lifetime exposure

In this section, we present lifetime exposure assessment calculations and use these to make conclusions about the suitability of each alternative based on human health impact. For each region, a table is presented detailing the average daily dose (ADD) over 30 years from birth to age 30. The ADD is compared to the NOAEL over 30 years (calculated by adding the NOAEL values over 30 years for each phase of life (infant, child, adult)). In addition, a figure comparing lifetime exposure to the implementation timeline for each CWS is presented to show how each intervention changes the exposure experience from birth to 30 years. In these figures, the red dotted line represents the NOAEL value at 30 years, the black trend represents lifetime exposure if no intervention is implemented, and the remaining curves represent the best case (shortest estimated time to implement) and worst case (longest estimated time to implement) in each CWS. In each figure, the estimated implementation timeline for each CWS is shown, as well as the number of years before exposure is expected to exceed the NOAEL value if no intervention is implemented (shown in black).

3.2.3.1 Region 1 Lifetime exposure results

In Region 1, all of the selected treatment systems' removal efficiencies and implementation timelines resulted in an ADD <NOAEL, sufficiently reducing exposure to arsenic to no observable adverse effect levels. If no intervention is implemented in Region 1, the total ADD over 30 years will exceed the NOAEL by 4.68 ug/kg/day (Table 3.11). If centralized treatment is implemented within 3 years, the total ADD over 30 years will be 4.18 ug/kg/day below the NOAEL. The largest decrease in exposure is seen when the POU carbon fiber adsorptive media device is implemented within 2 years (a decrease of 5.19 ug/kg/day), which is intuitive given the POU AM device has a removal efficiency of 99%.

Table 3.11: Region 1 lifetime exposure results over 30 years compared to an exposure to the NOAEL level of arsenic.

Improvement	Time to Implement (Years)	ADD over 30 years (ug/kg/day)	Compared to NOAEL (ug/kg/day)
No Intervention	-	12.78	+ 4.68
Central	3	3.92	- 4.18
	6	5.74	- 2.36
POU AM Device B	2	2.91	- 5.19
	5	4.81	- 3.29
POU RO Device D	2	3.12	- 4.98
	5	4.97	- 3.13

Table 3.11 presents results specific to the treatment options selected for each system. Figure 3.5 shows the best-and worst-case removal efficiencies and best-case/worst-case implementation timelines for each in Region 1 (the red dotted line represents the NOAEL value of 8.1 ug/kg/day over 30 years, the black trend line represents total exposure (ug/kg/day) assuming no intervention is implemented). In Region 1, assuming no intervention is implemented, the total dose a person will be exposed to exceeds the NOAEL value at 17.5 years based on an average pre-intervention total arsenic concentration of 8.1 ug/L.

According to CWS stakeholders in Region 1, a POU device can feasibly be implemented in 2-5 years while a centralized treatment improvement can be feasibly implemented in 3-6 years. While POU devices can be installed in households in a short amount of time in general, implementation can take as long as 5 years due to the requirement of 100% community buy-in prior to initiating piloting and permitting activities, which take additional time. In Region 1, Figure 3.5 shows that any alternative implemented in the timelines described by stakeholders will be implemented quickly enough to reduce 3-year exposure. Similarly, all best-case scenario removal efficiencies also remove enough arsenic from the system to reduce arsenic exposure below the cumulative 30-year NOAEL.

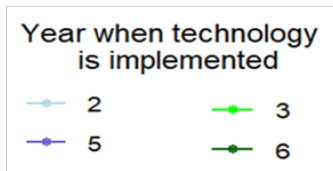
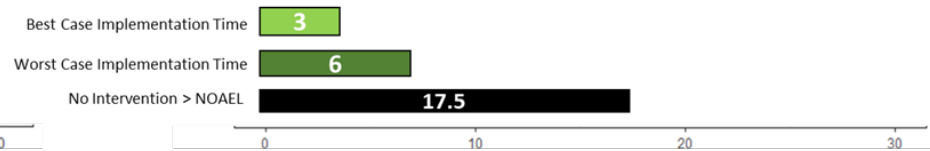
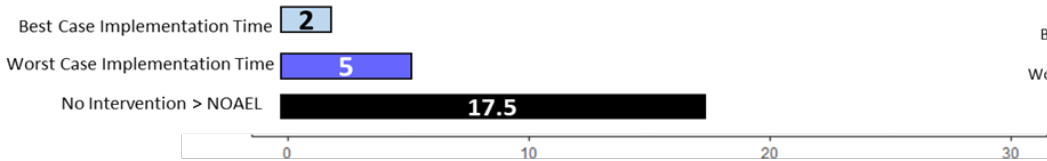
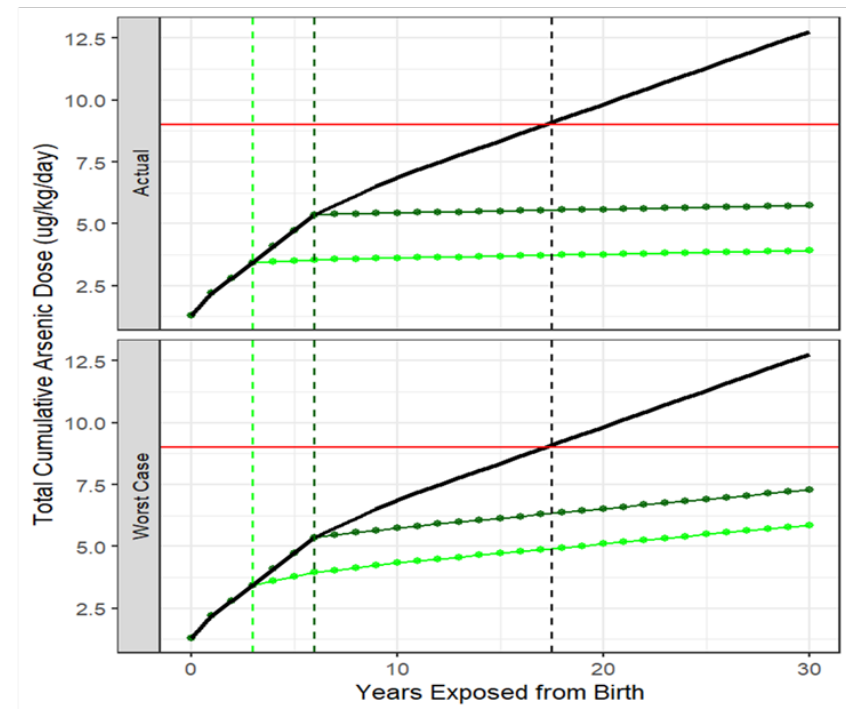
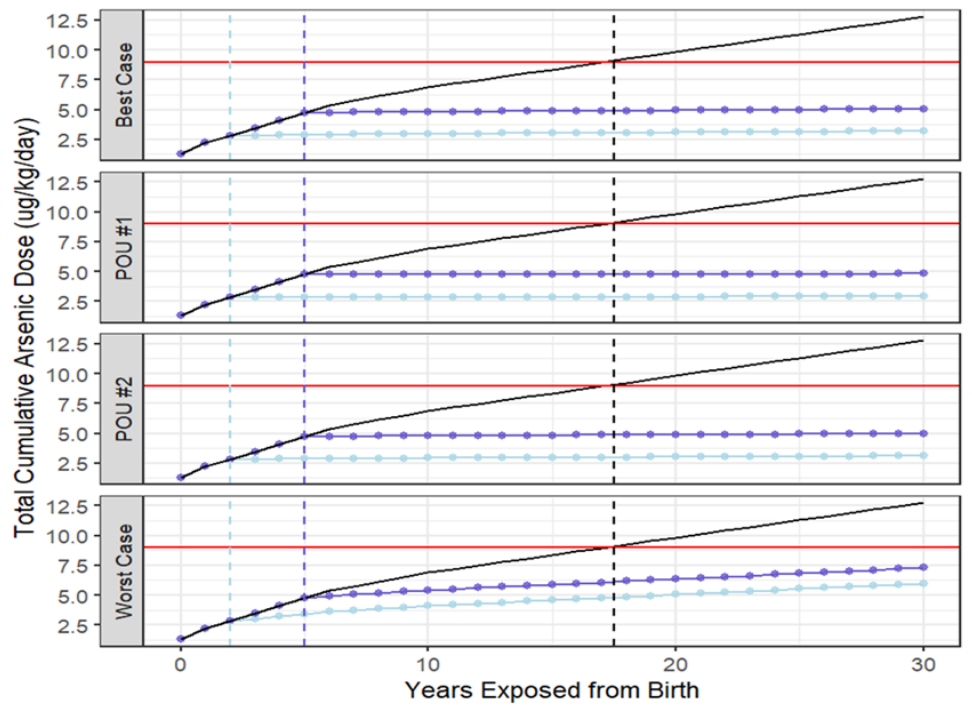

Figure 3.5: Lifetime exposure results for Region 1 based on specific CWS timelines for implementation.

3.2.3.2 Region 5 Lifetime exposure results

In Region 5, all of the selected treatment alternatives reduce 30-year exposure below the NOAEL. Table 3.12 indicates that without intervention, the ADD over 30 years is 14.36 ug/kg/day, which exceeds the 30-year cumulative NOAEL by 6.5 ug/kg/day. The largest decrease in exposure is achieved by POE Device K within a 3-year implementation best-case scenario, followed by POE Device N within 3 years. Centralized treatment, if implemented by 7 years, results in a cumulative exposure that is only 0.07 ug/kg/day below the cumulative 30-year NOAEL, indicating this option is still able to reduce exposure, but that beyond 30 years, there may be observable adverse effects in the community population.

Table 3.12: Region 5 lifetime exposure results over 30 years compared to an exposure to the NOAEL level of arsenic.

Improvement	Time to Implement (Years)	ADD over 30 years (ug/kg/day)	Compared to NOAEL (ug/kg/day)
No Intervention	-	14.36	+6.5
Central	4	6.55	-1.55
	7	8.04	-0.07
POE AM Device N	3	4.40	-3.70
	6	6.45	-1.65
POE AM Device K	3	4.08	-4.02
	6	6.30	-1.80

According to stakeholders in Region 5, POE could feasibly be implemented in 3-6 years while a centralized improvement is likely to take 4-7 years. The difference between these stems from differences in approval (piloting and permitting) and installation time. Because there are 221 homes in the Region 5 community, it is likely that installation of POE devices would require significant organizational effort, likely increasing implementation time. Notably, the centralized improvement we selected to address the contaminant concern is relatively simple to install. Assuming that the POE takes longer to implement because of the number of households, and centralized takes less time to install, both POE devices still provide a larger arsenic removal over 30-years, indicating the importance of removal efficiencies.

In Figure 3.6, we observed that if no intervention is implemented in Region 5, exposure will exceed the cumulative 30-year NOAEL value at 13.5 years. Any of the alternatives selected for Region 5 are likely to be implemented at this time according to the estimated timelines.

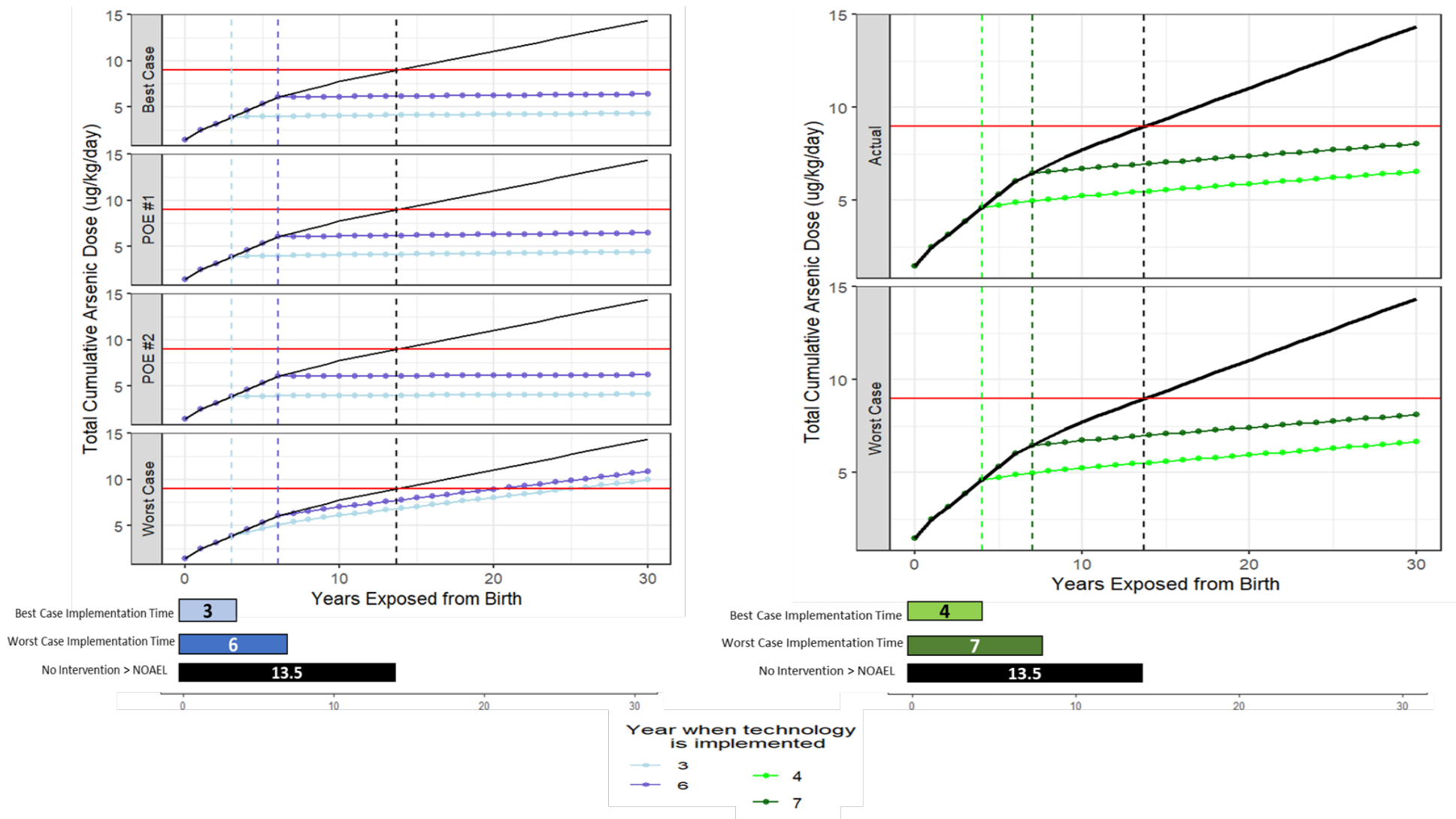

Figure 3.6: Lifetime exposure results for Region 5 based on specific CWS timelines for implementation.

3.2.3.3 Region 7 Lifetime exposure results

In Region 7, if no intervention is implemented, the total exposure dose over 30 years is 14.75 ug/kg/day, which exceeds the cumulative 30-year NOAEL by 6.65 ug/kg/day. In Region 7, the centralized treatment upgrade would have a better removal efficiency of nitrate than the POU RO device. As a result, using POU RO Device G (70% removal efficiency) generates a total exposure dose over 30 years of 8.25 ug/kg/day, which exceeds the cumulative 30-year NOAEL by 0.15 ug/kg/day if the device is implemented with a worst-case scenario of 5 years. All other alternatives can successfully decrease total exposure below the cumulative 30-year NOAEL.

Table 3.13: Region 7 lifetime exposure results over 30 years compared to an exposure to the NOAEL level of arsenic.

Improvement	Time to Implement (Years)	ADD over 30 years (ug/kg/day)	Compared to NOAEL (ug/kg/day)
No Intervention	-	14.75	+6.65
Central	4	5.72	-2.38
	6	7.05	-1.05
POU RO Device D	3	6.14	-1.96
	5	7.32	-0.78
POU RO Device G	3	7.21	-0.89
	5	8.25	+0.15

If a treatment upgrade is not implemented in Region 7, nitrate exposure will exceed the NOAEL in 13 years (according to Figure 3.7). In this region, centralized treatment was estimated to take 4-6 years and POU/POEs 3-5 years. The selected centralized treatment improvement requires a new facility rather than just an improvement to an existing facility and therefore, implementation is likely on the high end of the estimate. For POU, it is difficult to estimate implementation time as there are few POU installations used for compliance in Nebraska and the community does need to have all 75 households agree prior to implementation.

In Region 7, the worst-case scenarios for both centralized and POU removal efficiencies would both exceed the cumulative NOAEL after year 25.

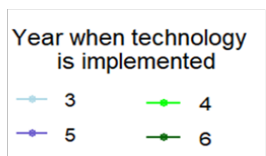
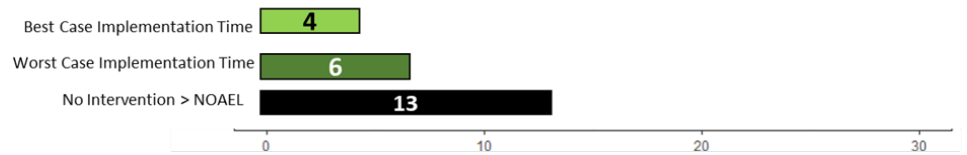
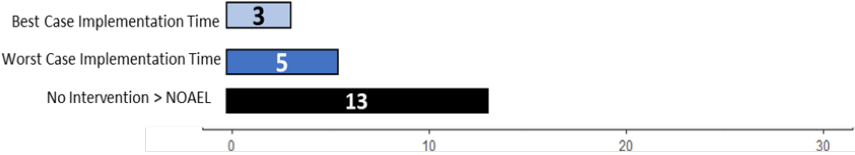
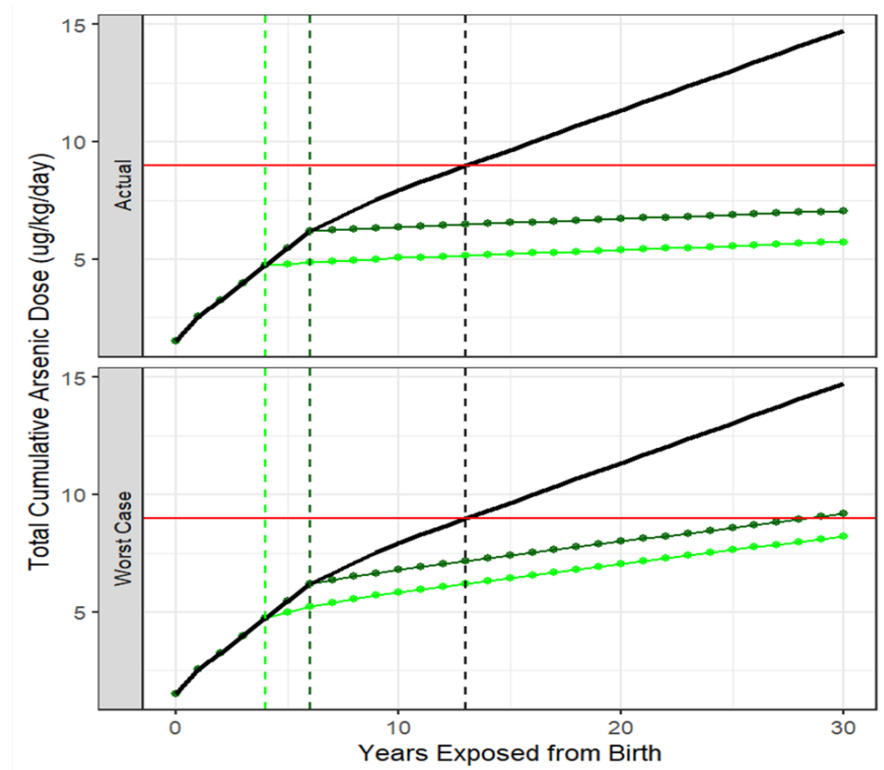
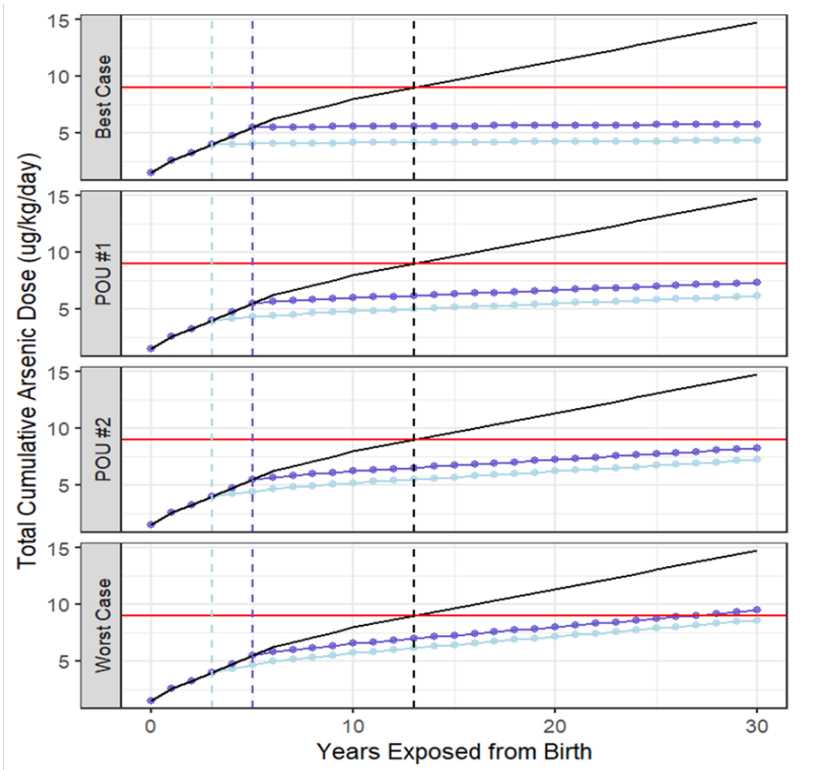

Figure 3.7: Lifetime exposure results for Region 7 based on specific CWS timelines for implementation.

3.2.3.4 Region 9 Lifetime exposure results

In Region 9, there was no combination of removal efficiency and implementation timeline among the selected alternatives that sufficiently reduces 30-year exposure below the cumulative 30-year NOAEL. The initial concentration of total arsenic in this water system exceeded 20 ug/L, and if no intervention is implemented, would result in a 30-year exposure dose of 34.08 ug/kg/day, exceeding the cumulative 30-year NOAEL by 25.98 ug/kg/day (Table 3.14) (and would exceed the cumulative 30-year NOAEL of 8.1 ug/kg/day within 3 years). Our results indicate that, given their higher removal efficiencies and faster timelines, only a POU unit could be implemented fast enough to decrease exposure to below acceptable limits. If the POU carbon fiber adsorptive media device with a 99% removal efficiency was implemented as fast as possible (3 years or potentially less), the total dose over 30 years decreases to 9.45 ug/kg/day which exceeds the 30-year cumulative NOAEL by 1.35 ug/kg/day.

Table 3.14: Region 9 lifetime exposure results over 30 years compared to an exposure to the NOAEL level of arsenic.

Improvement	Time to Implement (Years)	ADD over 30 years (ug/kg/day)	Compared to NOAEL (ug/kg/day)
No Intervention	-	34.08	+25.98
Central	4	12.06	+3.96
	6	15.03	+6.93
POU AM Device B	3	9.45	+1.35
	5	12.83	+4.73
POU RO Device D	3	9.95	+1.85
	5	13.26	+5.16

Figure 3.8 reveals that no selected alternatives, nor the best-case/worst-case scenarios, could sufficiently decrease arsenic exposure in Region 9 within the estimated implementation timelines given the high concentration of arsenic. In Region 9, an alternative solution that had been explored by the CWS previously was using a new well with lower arsenic concentration. If a switch to a well with lower arsenic concentrations were made and POU devices were installed within the estimated timelines, human exposure to arsenic could be sufficiently decreased below the cumulative 30-year NOAEL threshold in Region 9.

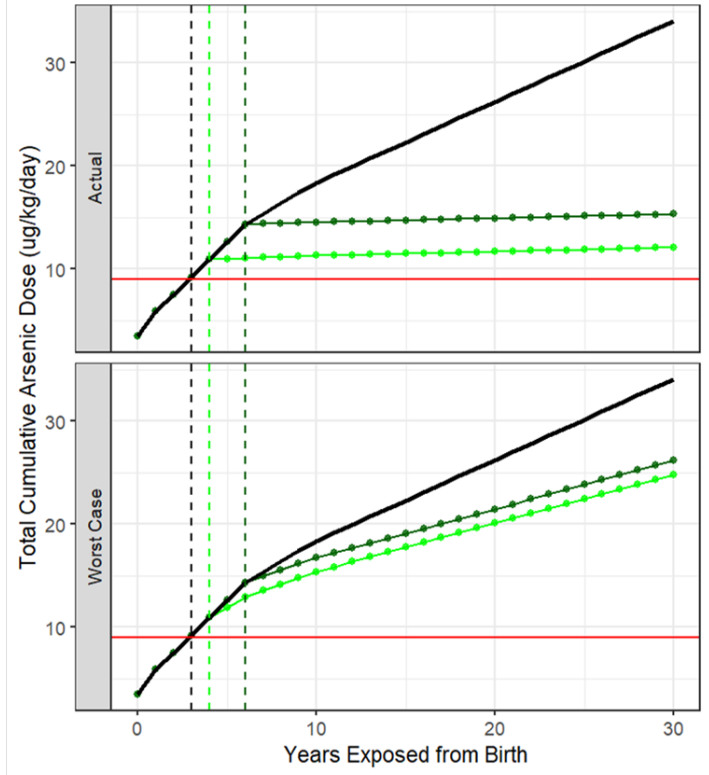
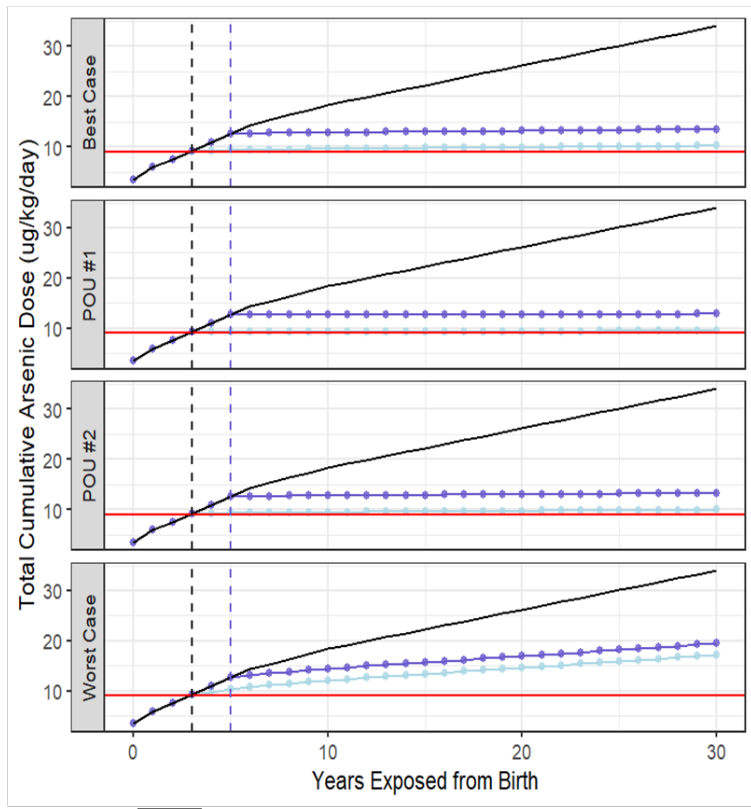

Best Case Implementation **3**

Worst Case Implementation **5**

No Intervention > NOAEL **3**

Best Case Implementation Time **4**

Worst Case Implementation Time **6**

No Intervention > NOAEL **3**

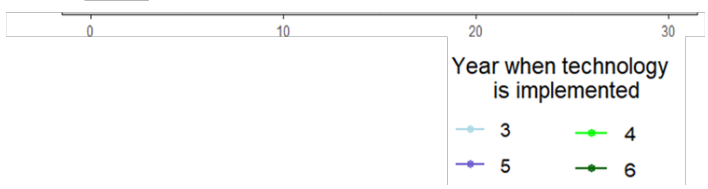

Figure 3.8: Lifetime exposure results for Region 9 based on specific CWS timelines for implementation

3.2.3.5 Summary of lifetime exposure results

In the Regions 1 and 5 cases, all potential alternatives sufficiently removed arsenic within the timelines outlined by the CWS stakeholders. In Region 7, due to a smaller removal efficiency of nitrate, POU RO Device G would not reduce nitrate exposure below the cumulative 30-year NOAEL, while centralized treatment would achieve sufficient reduced nitrate exposure. In Region 9, no combination of selected upgrades, removal efficiencies, and timelines available decreases arsenic contamination below the cumulative NOAEL, but a faster implementation timeline for the POU AM device or an additional improvement of changing the source water well could provide the additional steps necessary to sufficiently reduce arsenic exposure.

Table 3.15: Summary of lifetime exposure modeling. The NOAEL value used for comparison is 8.1 ug/kg/day over 30 years (calculated by multiplying the 0.27 ug/kg/day adjusted NOAEL by 30 years). The total ADD over 30 years is compared to the NOAEL; a positive value indicates the calculated ADD >NOAEL, negative values indicate calculated ADD < NOAEL.

Region	Improvement	Time to Implement (Years)	ADD over 30 years (ug/kg/day)	Compared to NOAEL (ug/kg/day)
Region 1	No Intervention	-	12.78	+ 4.68
	Central Upgrade	3	3.92	- 4.18
		6	5.74	- 2.36
	POU AM Device B	2	2.91	- 5.19
		5	4.81	- 3.29
	POU RO Device D	2	3.12	- 4.98
		5	4.97	- 3.13
	Region 5	No Intervention	-	14.36
Central Upgrade		4	6.55	-1.55
		7	8.04	-0.07
POE AM Device N		3	4.40	-3.70
		6	6.45	-1.65

	POE AM Device K	3	4.08	4.02
		6	6.30	-1.80
Region 7	No Intervention	-	14.75	+6.65
	Central Upgrade	4	5.72	-2.38
		6	7.05	-1.05
	POU RO Device D	3	6.14	-1.96
		5	7.32	-0.78
	POU Device G	3	7.21	-0.89
5		8.25	+0.15	
Region 9	No Intervention	-	34.08	+25.98
	Central Upgrade	4	12.06	+3.96
		6	15.03	+6.93
	POU AM Device B	3	9.45	+1.35
		5	12.83	+4.73
	POU RO Device D	3	9.95	+1.85
5		13.26	+5.16	

Based on the exposure assessment results, we ranked each treatment upgrade in each region (Table 3.16) (ranked as 3, 2, 1, with 3 as the option that most effectively decreased contaminant exposure, and subsequently 2 and 1). The highest-ranked options based on exposure assessment are:

Region 1) POU AM device B implemented in a 2–5-year time frame

Region 5) POE Device N implemented in a 3–6-year timeframe;

Region 7) Centralized IX implemented in a 4–6-year timeframe;

Region 9) POU AM device implemented as soon as feasibly possible.

Table 3.16: Rankings for each option in all regions based on the lifetime exposure assessment results.

Region	Technology	Metric
		Decrease in contaminant exposure (ug/kg/day)
		3 = Best Option, 2 = 2 nd Best Option, 1 = 3 rd Best Option
1	Centralized Upgrade	1
	POU AM Device B	3
	POU RO Device D	2
5	Centralized Upgrade	1
	POE AM Device N	2
	POE AM Device K	3
7	Centralized Upgrade	3
	POU RO Device D	2
	POU RO Device G	1
9	Centralized Upgrade	1
	POU AM Device B	3
	POU RO Device D	2

4 – Life Cycle Analysis (LCA)

4.1 Methods

To understand the environmental sustainability of the alternatives selected, we used a life cycle analysis (LCA). LCAs can be process-based and economic input-output (EIO) models. Process-based LCAs connect the inputs to a product or system (including the materials and energy) to outputs of those specific inputs (emissions, wastes). However, this approach can be limited by insufficient data and intensive time and cost requirements (Bilec et al., 2006). The EIO-LCA approach uses US industrial sector input-output tables to map interdependencies between sectors, which includes supply chains into each sector. While the advantages of this method include examining the entire US economy and its role in environmental impacts and the data are publicly available, the ability to draw conclusions is limited by its aggregation of results. We therefore elected to use the process based LCA methodology, as it provides greater resolution in results when comparing the complex details of centralized treatment improvements to POU/POE devices.

LCAs consist of four phases: (1) definition of the goal and scope, (2) life cycle inventory, (3) life cycle impact assessment and (4) data interpretation (ISO, 2006) (Figure 4.1). The definition of goal and scope involves setting the system boundaries and defining a functional unit. The functional unit serves to standardize material flows, enabling generation of accurate comparisons of alternative products. The life cycle inventory component involves generating a database of the system or process components, including the material, size, and other relevant information for calculating the total amounts of a component used. LCAs connect the life cycle inventory to a database of process flow information and estimate the environmental impact (measured by greenhouse gas emission, ecotoxicity, etc.) of each defined process (ISO, 2006). Based on the inventory inputs and method used, the LCA practitioner then analyzes and interprets the data, often using sensitivity analyses.

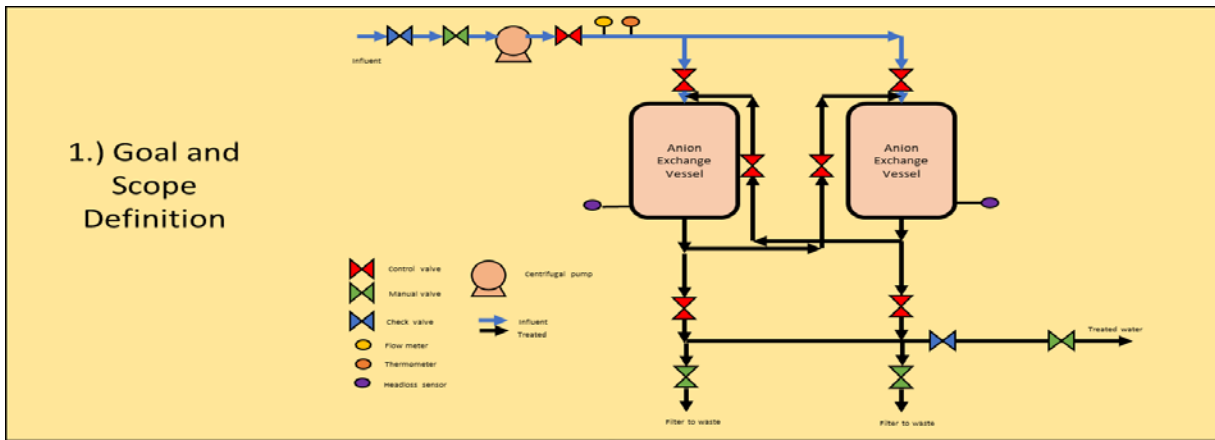

2.) Life cycle inventory

Component	# of Components	Units	Material	Size	Cost per Unit	Total Cost	Useful Life
Inlet/outlet piping	-	ft^2	PVC	1.5 in diameter, 40 ft	\$2.99	\$119.60	17
Check valves	2	valve	PVC	1.5 in diameter	\$171	\$342	17
Manual valves	2	valve	PVC	1.5 in diameter	\$241	\$482	17
Centrifugal pump	1	pump			\$292	\$584	17
Control valve	7	valve	PVC	2 in diameter	\$682	\$4,774	17
Flow meter	1	device	-	1.5 in diameter	\$2,239	\$2,239	14
Thermometer	1	device	-	-	\$593	\$593	14
Headloss sensor	2	device	-	-	\$2,121	\$4,242	14
Vessel	2	vessel	Fiberglass	59 gallons (4.5 ft in height, 1.5 ft diameter)	\$2,033	\$4,066	20
Resin	-	ft^3	Nitrate Selective Resin	8 ft^3, bed depth of 2.4 ft	\$183.88	\$2,942.08	NA
Process piping	-	ft	PVC	2 in diameter, 40 ft	\$3.30	\$132.00	17
Conductivity sensor	1	device	-	-	\$1,616	\$1,616	14

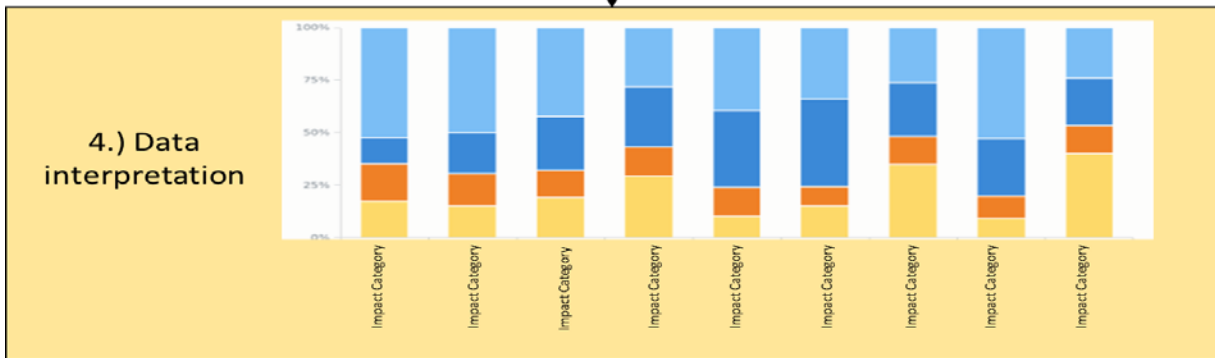
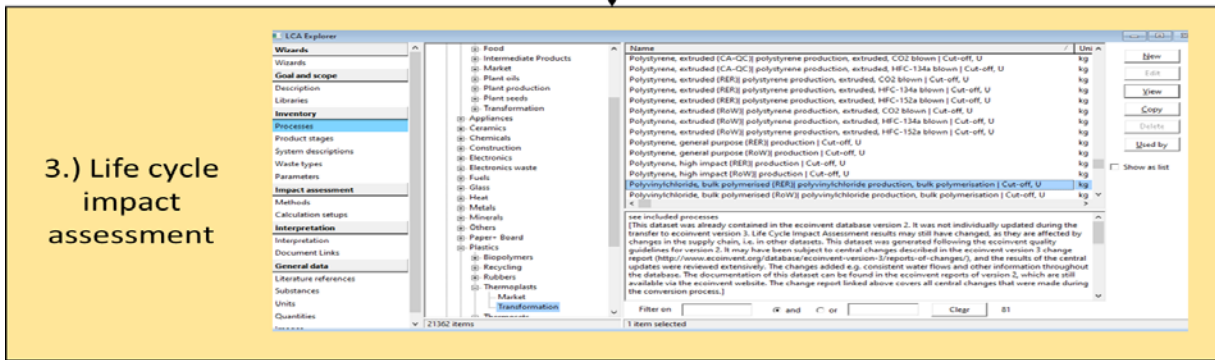

Figure 4.1: LCA methodology components adapted from the ISO, 14040 standard (ISO, 2006).

4.1.1 Functional Unit

We originally proposed to use a functional unit of 1 m³ (1000 L) of water produced; however, after a more extensive literature review, we selected a functional unit of one household. We decided not to use a volume of water because the volume of water consumed per household per day is variable across each household and community, and the flow rate for each community also differs. Normalizing by the flow rate may obscure the importance of the number of households in a community. Furthermore, POU/POE devices commonly rely on volume as an indicator of when service or device replacement is needed; because water use is variable per household, devices will fail at different rates. For central treatment, the water volume produced is not expected to change significantly as a result of the selected improvements in each community. We therefore normalized the amount of material in a device or centralized upgrade per household over the total 30-year study period to compare the impact assessment. We used the useful life of each component to extrapolate the number of replacements of each component over a 30-year time frame and calculated the total mass of material (in kg) for each treatment option. This allowed us to compare options at a household level and find the breakpoint number of homes per community at which one option becomes more or less environmentally sustainable than the other. By calculating the amount of material per household, we can also account for an increase or decrease in the number of customers served by the CWS if the population of the community changes over time.

4.1.2 Software and Databases

The SimaPro software contains several databases from which the life cycle inventory can be completed. For this study, we used the ecoinvent 3 database, which provides information about the process flows for specific materials and processes needed to generate the materials present in each of the selected treatment options. Using this database, we generated process flows for each centralized improvement and each POU/POE device based on an inventory (described below). We then selected the TRACI 2.1 analysis method to translate the process flows into environmental impacts. TRACI 2.1 is commonly used in North America to conduct data analysis in LCAs with supporting documentation from the USEPA (USEPA, 2020c).

4.1.3 System boundaries and data collection

The system boundaries for this analysis encompassed only the upgrades made to the centralized system, or the entire POU/POE device installed. Using SimaPro, we traced raw inputs, material processing, transportation, and disposal of each of treatment options for each CWS. We considered the following impacts: conventional air pollutants (e.g., Sox, NOx, PM, VOCs, CO), greenhouse gases, energy use (GJ/functional unit), toxic chemical releases, water withdrawals, ecotoxicity, acidification, eutrophication, global warming potential and others.

The system boundaries, existing system, and additional components needed for the centralized water treatment system in Region 1 is shown in Figure 4.2 (the pre-implementation components shown in gray and additional components needed to complete the improvement shown in color). While pre-existing system components will likely need to be replaced within the 30-year period, we focused our

analysis only on the upgrades to the system necessary for meeting the isolated treatment objective also addressed by the contaminant of concern, for adequate comparison to the POU/POE systems.

In Region 1, we consulted stakeholders to determine which components were already in place in this CWS since the selected improvement involves adding an additional filtration unit. In Region 1, backwashing equipment for the absorptive media system are already in place; as a result, no piping or storage tanks for backwash water were included in the LCA inventory. The current treatment facility is fed by a submersible pump in the well and has sufficient capacity to continue to pump to an additional adsorptive media filter (the centralized upgrade). We therefore excluded a pump from the inventory. We included several sensors, including headloss sensors, turbidity meters, and high/low alarms for the second adsorptive media filter. As a result, Region 1 centralized materials primarily consist of the new filter housing (fiberglass), the filter media (granular ferric hydroxide), and additional piping and valve components to feed the second filtration unit (PVC).

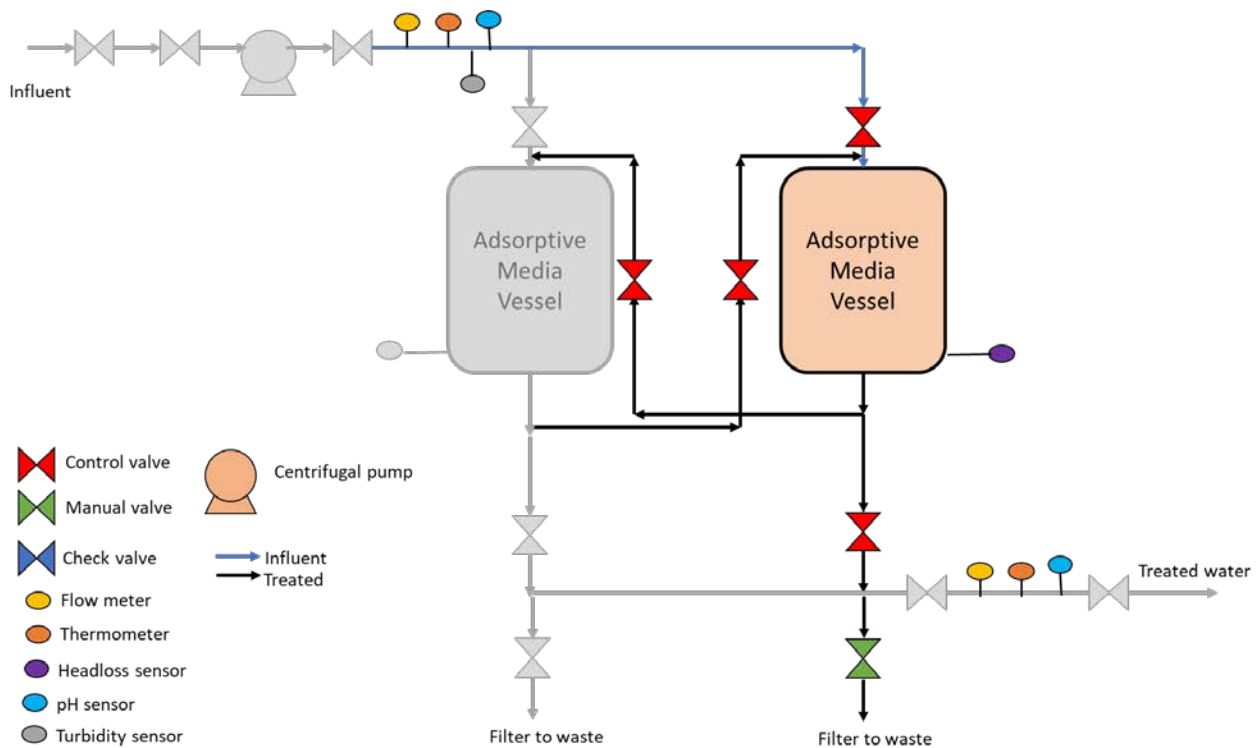

Figure 4.2: Components included within the system boundaries for Region 1’s LCA are shown in color while pre-existing components are shown in grey.

In Region 5, we worked with stakeholders to determine which pre-oxidation components were already in place to identify whether components could be repurposed or should be newly installed (illustrations and details of system boundaries in Appendix A). After several conversations, we decided to model a worst-case scenario and install a new chemical feedline, calibration cylinder, and chemical feed pump to the system. The chlorine disinfection unit is located within the pump house and

configured to provide chlorine gas for both pre-oxidation after aeration and a disinfectant residual after sand filtration. The aeration tower is located outside the treatment facility, and it remained unclear whether the current system could be adapted to locate a chlorine supply ahead of aeration. As a result, we modeled the full inventory of components necessary to install pre-chlorination, using the EPA Design Manual for Iron Removal which contains pre-treatment options (USEPA, 2006a).

Region 7 does not have a treatment system, although there is space for installing new treatment components (illustrations and details of system boundaries in Appendix A). As a result, we inventoried all components necessary to install a new anion exchange system, including 2 vessels, backwashing equipment, all sensors, piping, valves, and redundant components. Per Nebraska regulations, we also included the materials and cost associated with installing basic chlorine disinfection, as chlorine disinfection would then be required once any type of treatment system is implemented. After conversations with stakeholders, it remained unclear if there was water storage prior to distribution; we therefore included a storage tank in the inventory to reflect the worst-case scenario.

In Region 9, we included all components necessary to install a new anion exchange system and the additional components necessary for handling waste disposal (illustrations and details of system boundaries in Appendix A). We did not include the cost and material to build a treatment facility as there is an already existing treatment plant. To handle waste disposal, we included an evaporation pond based on recommendations from state-level stakeholders consisting of two filtration vessels, the piping and pumping required for regenerating the ion exchange resin onsite, and an evaporative pond sized for 30 household connections (USEPA, 2006a).

For POU/POE devices, the system boundary includes the device itself (including pre-filters, post-filters and sensors included in the device), the separate faucet installed at each connection, and any process piping to connect the POU/POE device to the separate faucet (Appendix D). For some of the selected devices, these components would be included in the overall device cost and package and were easily identified through device manuals and manufacturers. For POE devices in particular, the piping necessary may not be included in the cost of the device depending upon the distributor, necessitating additional piping.

4.1.3 Inventory generation

To perform an LCA, an inventory of the material and size of each component in the selected upgrades was needed.

For centralized treatment system upgrades, the process flow schematics for each water system were used to create a component list for each CWS, which we then used along with the EPA Work-based Structure (WBS) cost models to construct an inventory for each improvement (USEPA, 2021a) (Table 4.1). The EPA WBS models were created to allow water systems to explore the cost of installing specific treatment solutions based on the system size (based on the average daily flow). For Region 1, we used the US EPA Adsorptive Media Cost Model with a granular ferric hydroxide (GFH) media and the EPA standard design for small systems (average daily flow rate = 0.03 MGD) (USEPA, 2021c). In

Regions 7 and 9, we used the Anion Exchange cost model, with a nitrate selective resin for Region 7 and a strong base polyacrylic resin for Region 9 (USEPA, 2017b). In Region 5, we were unable to access a cost model specifically for pre-oxidation; we instead consulted other chemical addition models under development by the EPA to generate a list of components to create an inventory for Region 5.

Table 4.1: A cost model and set of model assumptions were selected for each CWS to generate an inventory of components for each centralized treatment upgrade (USEPA, 2017b, USEPA, 2021c).

EPA Region	Centralized Improvement	EPA WBS Cost Model	Input assumptions
1	Treatment of 100% of the flow rate by adding an additional filtration module	Adsorptive Media (granular ferric hydroxide media)	Average daily flow rate = 0.03 MGD Media is thrown away after 45,000 Bed Volumes (BVs) 1 additional vessel, EBCT = 3.6 minutes
5	Enhance pre-oxidation by moving pre-chlorination step ahead of aeration	Not applicable Generated a list of potential components using chemical addition models	Average daily flow rate = 0.03 MGD
7	Centralized anion exchange with a nitrate selective resin	Anion Exchange – Nitrate selective resin	Average daily flow rate = 0.03 MGD Throwaway media after 22,000 BVs 2 vessels in series Residuals disposed of at a wastewater facility Bed depth of 2.4 ft EBCT = 3 minutes (1.5 min per vessel)
9	Centralized anion exchange with a strong base anion resin	Anion Exchange – Strong Base Polyacrylic resin	Average daily flow rate = 0.03 MGD Throwaway media after 40,000 BVs 2 vessels in series Disposal of residuals to an evaporative pond EBCT = 12 minutes

For POU/POE devices, we contacted manufacturers to locate device manuals and generated component lists based on these materials. Manuals were located for four (all 3 POU devices and 1 POE device) of the five devices from manufacturer’s websites, with the fifth POE device manual obtained via email with the manufacturer. From the manuals, we generated a list of components for each device separately and then cross-referenced the lists to determine missing components for any one device. For example, some device manuals include schematics of the process piping necessary to install a POU device with a separate faucet under the sink while other manuals only include the POU device itself. In this scenario, we included process piping for POU device in the inventory when device manuals indicate process piping would be necessary. We also consulted with manufacturers to determine what

process piping needs to be included to install POU devices if no information was provided in the manuals.

For each technology option, we calculated the amount of material needed per household over 30 years in kilograms. First, we calculated the amount of material for each component: for example, if a both a process valve and a length of piping are made of polyvinylchloride, we calculated the amount of each component separately. This allowed us to examine whether specific components contributed more to the impact assessment in initial analysis to determine how granular of detail was necessary. From this initial analysis, we concluded we could combine components to obtain a total amount of material for each material type (e.g., PVC, GAC, polypropylene) when calculating the raw material and processing components of the LCA.

Prior to conducting the impact assessment, we calculated individual components of the life cycle separately (i.e., raw material extraction and processing were calculated in one step and waste disposal was calculated in a separate step) for the following reasons: (1) the SimaPro software requires a specific “waste type” when inputting waste disposal scenarios and not all materials used in the technology options are represented in the preloaded waste types, and (2) materials such as granular ferric hydroxide media (used in the Region 1 centralized improvement and POE devices in Region 5) are difficult to represent with preset processes. As a result, it became difficult to link raw material inputs and processes to waste disposal scenarios using the preloaded structures in SimaPro. To ensure we did not over- or under-estimate the impact of materials such as adsorptive medias, we ran a basic analysis to determine the impact of 1 kg of material and then exported the SimaPro results for further analysis, allowing us to adjust these components to the desired functional unit without unintentionally introducing errors.

To calculate transportation impacts, we searched for processing facilities and municipal landfills located close to each CWS using Google Maps. We searched for plastics processing locations, iron and steel processing facilities, local manufacturers of ion exchange resin and adsorptive media, and locations where raw materials are extracted. We then took the average of the distance from each raw material extraction location to the processing facility to the community to obtain a distance in kilometers necessary to transport raw materials to a processing facility and then to the community. Using the amount of material, we translated this distance into units of tonne-kilometers to calculate transportation impacts in SimaPro. We also located at least two municipal landfills close to each CWS and averaged the distance from the CWS to the landfill to calculate the transportation distance in tonne-kilometers (Table 4.2).

Table 4.2: Distances used to calculate transportation impacts in each CWS.

Community water system	Transport of processed materials to CWS (km)	Transport of materials from CWS to landfill (km)
New Hampshire (Region 1)	56.3	16.1
Illinois (Region 5)	24.1	24.1
Nebraska (Region 7)	24.1	24.1
California (Region 9)	96.6	193.1

Finally, SimaPro had a built-in material for anionic exchange resins and granular activated carbon medias, but not for specific adsorptive medias such as granular ferric hydroxide (GFH). We explored using the base material of GFH medias (commonly pumice or sand) and creating a new process in SimaPro to represent the coating of GFH media. However, of the built-in coating processes in SimaPro are specific to metal working and not appropriate for coating adsorptive medias. Little literature exists detailing how adsorptive media was accounted for in water treatment LCAs; we therefore modeled the GFH media as similar to GAC. While it is possible to define a new process in SimaPro, it requires known environmental impacts of the process. However, we were unable to locate information on the processing and disposal of GFH media through either literature or manufacturer website search. Therefore, we modeled GFH as GAC for simplicity, however, since there was a lack of information on specific GFH media, the impacts associated with the GFH media may constitute an underestimation or overestimation of the total impact. Notably, the extraction of coal and other base materials to generate activated carbon have high ecotoxicity impacts as analyzed using the TRACI 2.1.

4.1.4 Impact Assessment

Using the TRACI 2.1 database in SimaPro, we calculated the impact of each treatment option. In SimaPro, we created assemblies for each using the identified components. For example, for the POU AM device in Region 1 and 9, we created an assembly that included piping materials, filter cartridges, stainless steel faucets, and other additional components. We then set up a calculation for each assembly using the “Analyze” function in SimaPro. We selected “inventory by sub-component” to better pinpoint which materials contribute the most to the environmental impacts. We then created “Life Cycles” in SimaPro using the material assemblies described above and included the waste disposal scenario and transportation. The results from each analysis were exported to Excel for further analysis and interpretation.

4.1.5 Data Interpretation

To compare data across technologies, we normalized the impact assessment results to the largest impact category for each material. We compiled the data from each alternative for a given CWS and identified the largest impact category for each material. We then divided each entry by the largest impact to obtain normalized results. For each scenario, this generates a number from 0 to 1, with the largest impact as 1.

4.2 Results

4.2.1 Inventory generation

We generated inventories for the following centralized improvements: adsorptive media filtration in Region 1 and anion exchange for both Regions 7 and 9. We worked with community stakeholders in Region 5 to delineate the system boundaries of the centralized pre-oxidation upgrade. In Region 5, we modeled changing the order of the current pre-oxidation system by moving pre-chlorination ahead of the current aeration unit. Because the CWS in Region 5 has many of the components necessary to implement this upgrade already in place, we conducted phone calls with stakeholders to determine

which to include in the inventory. Examples of inventories are provided below with additional details in Appendix D.

4.2.1.1 Centralized improvement inventories

Table 4.3 provides an example of an inventory generated for centralized anion exchange with a nitrate selective resin in Region 7. Using the assumptions provided in Table 4.1, we consulted the Output tab of the EPA WBS Anion Exchange Cost Model (USEPA, 2017b) and selected the relevant components from the detailed output that matched the components we identified as necessary for Region 7 (Appendix A, Figure A3). We identified the component, the corresponding entry in the cost model output (not shown), the material where available, the size of the component, the unit cost of a component, the total cost of the component (as calculated by the EPA cost model algorithms), and the useful life. Since this study examines a 30-year timeframe, we calculated the number of replacements necessary in this timeframe based on each component’s useful life. This number of replacements was used to adjust the total amount of material calculated by the equations in the EPA cost models to accurately account for replacements over 30 years. The example inventory in Table 4.3 does not include the addition of a chlorine disinfection system or water storage for the CWS (these details are included in the Appendix); each of these, including the IX system, the backwashing components, and the chlorine disinfection components, are inventoried separately with a process in line with the above (not shown in Table 4.3). Table 4.3 presents the amount of material per centralized anion exchange system component, representing the amount of material per home. The amount of material in Region 7 is found by multiplying the amount of material per device by the 75 connections in the community to show how the number of homes impacts the amount of material entered into the impact assessment of the LCA.

Table 4.3: Example inventory for centralized anion exchange with a nitrate selective resin in Region 7

Component	# of Components	Units	Material	Useful Life [years]	Amount of material [kg]	Amount Region 7 (75 homes) [kg]	Amount of material over 30 years [kg]
IX System							
Inlet/outlet piping	-	ft ² ft ²	PVC	17	36.89	2,767.06	73.79
Check valves	2	valve	PVC	17	0.23	17.29	0.46
Manual valves	2	valve	PVC	17	0.23	17.29	0.46
	2	valve	PVC	17	0.23	17.29	0.46
Centrifugal pump	1	pump	Cast iron	17	203.88	15,291.07	407.76
Control valve	7	valve	PVC	17	0.24	18.04	0.48
Vessel	2	vessel	Fiberglass	20	0.90	67.16	1.79
Resin (polyacrylic beads)	16	ft ³ ft ³ /yr.	Nitrate Selective Resin	1	435.84	32,688.00	13,511.04
Process piping	-	ft	PVC	17	38.48	2,885.99	76.96

Backwashing							
Tank	1	vessel	Fiberglass	20	0.46	34.15	0.91
Piping	50	ft	PVC	17	28.24	2,118.02	56.48
motor/ air-operated valves	8	valves	PVC	20	0.14	10.59	0.28
check valves	2	valves	PVC	20	0.14	10.59	0.28
rinse pumps	2	pumps	Cast iron	17	815.53	61,164.39	1,631.05
Chlorine disinfection							
Storage tank	1	vessel	fiberglass	20	0.46	34.15	0.91
chemical metering pump	2	pump	PVC	15	0.29	64.66	0.59
check valves	4	valves	PVC	20	0.29	64.66	0.29
pressure relief valves	4	valves	PVC	20	0.29	64.66	0.29
suction tubing	4	ft	PVC	5	1.17	258.65	7.02
discharge tubing	4	ft	PVC	5	1.17	258.65	7.02
chemical mixer	1	unit	PVC	22	10.22	2,258.08	10.22
process piping	110	ft	PVC	17	0.29	64.66	0.29
Dosing pump	1	pump	Cast iron	17	203.88	45,057.77	203.88

4.2.1.2 POU/POE Device Inventories

We created inventories for the five POU/POE devices based on information obtained from a variety of sources (Table 4.4).

Table 4.4: For each region, we obtained a device manual by searching manufacturer websites or by contacting manufacturers and called manufacturers to obtain additional data where necessary to identify device removal rates for specific contaminants and identify all device components.

EPA Region	Device	Manual	Conversation with Manufacturer
1	POU Device B, Adsorptive Media (Carbon fiber)	Obtained from manufacturer website	July 2021
	POU Device D, RO	Obtained from manufacturer website	August 2021
5	POE Device K, Adsorptive Media (GFH)	Obtained from conversation with manufacturer	January 2022
	POE Device N, Adsorptive Media (GFH)	Obtained from manufacturer website	July 2021
7	POU Device D, RO	Obtained from manufacturer website	August 2021

	POU Device G, RO	Obtained via email with manufacturer and distributor	September 2021
9	POU Device B, Adsorptive Media (Carbon fiber)	Obtained from manufacturer website	July 2021
	POU Device D, RO	Obtained from manufacturer website	August 2021

To complete the LCA in SimaPro, we calculated the amount of material per device and per community over a 30-year period. Table 4.5 shows two RO devices selected in this study and the amount of material both per device and per community (scaled to per community by multiplying by the number of homes in the community). Both RO devices contain the same materials in differing amounts by size and configuration. We found the amount of material over 30 years by calculating the number of replacements of each component and then using the number of replacements to calculate the total amount of material over 30 years. The amount of material for the communities in Regions 1, 7, and 9 are shown to demonstrate how the number of households impacts the amount of raw material entered into the LCA impact assessment. Details for each POU/POE device are in Appendix D in Tables D1-5.

Table 4.5: Inventory of material for two POU RO devices

		Material (kg)											
		Fiberglass		Polypropylene		Polysulfone		Stainless Steel		PVC		GAC	
		POU RO Device D	POU RO Device G	POU RO Device D	POU RO Device G	POU RO Device D	POU RO Device G	POU RO Device D	POU RO Device G	POU RO Device D	POU RO Device G	POU RO Device D	POU RO Device G
Amount of Material (kg) per Device		0.01	0.01	0.001	0.001	0.004	0.004	0.86	0.01	0.04	0.00	0.57	0.57
Initial Installation	Amount of Material for Region 1 (24 homes)	0.33	0.33	0.02	0.02	0.10	0.10	20.63	0.18	0.96	0.00	13.77	13.77
	Amount of Material for Region 7 (75 homes)	1.02	1.02	0.06	0.06	0.31	0.31	64.47	0.57	3.01	0.00	43.03	43.03
	Amount of Material for Region 9 (29 homes)	0.40	0.40	0.02	0.02	0.12	0.12	24.93	0.22	1.16	0.00	16.64	16.64

Over 30 years	Amount of Material for Region 1 (24 homes)	0.33	0.33	0.55	0.55	0.60	0.60	20.63	0.18	1.70	0.00	413.13	413.13
	Amount of Material for Region 7 (75 homes)	1.02	1.02	1.71	1.71	1.86	1.86	64.47	0.57	5.31	0.01	1291.03	1291.03
	Amount of Material for Region 9 (29 homes)	0.40	0.40	0.66	0.66	0.72	0.72	24.93	0.22	2.05	0.00	499.20	499.20

The amount of material in each POU RO device is similar for filter components such as the fiberglass housing, the size and amount of polysulfone in an RO membrane, the amount of polypropylene in sediment filter cartridges, the amount of PVC piping needed to connect the devices, and the amount of GAC in pre- and post-filters. However, RO Device D has more stainless-steel components due the additional faucet components and filter housing materials. Over 30 years, components such as fiberglass filter housings and stainless-steel faucet components and housings did not need replacement based on their useful life. However, components such as RO membranes (polysulfone), sediment prefilters (polypropylene), and GAC filters need to be replaced every 3-5 years for RO membranes and every year for pre- and post-filters; the -year material amount for these components therefore noticeably increases from the initial installation.

Similarly, for the POU adsorptive media device used in Region 1 and Region 9, carbon fiber filters constitute a large amount of the materials due to frequent replacement within 30 years. The stainless-steel housing used in the POU AM device also contributes a large amount of material to the overall inventory. For the POE devices selected for Region 5, filter media (gravel under-bedding and granular ferric hydroxide media) generate a larger amount of material to the overall device inventory compared to the POU devices. Because POE filtration devices are larger than POU filters, they also require more material for filter housings (fiberglass) and piping (PVC) in Region 5 than the POU's for Regions 1 and 9.

4.2.2 Impact Assessment

Impact assessment results are presented in detail in this section for each region, each as two panels: Panel A presents the normalized results to show the relative portion of each component of the life cycle (raw materials, transport, processing and end of life) and Panel B which presents a comparison of each treatment option, normalized to the highest value for impact in each impact category among all three alternatives.

4.2.2.1 Region 1 Impact Assessment Results

In Region 1, processing and waste disposal facilities are located relatively close to the CWS, resulting in a small transportation component to all three alternatives (Figure 4.3A). For the centralized improvement, the end-of-life had a larger fraction of the total impact for the ecotoxicity, eutrophication, and non-carcinogenics, driven in part by the disposal of the adsorptive media material to a landfill. While the POU AM device also has adsorptive media, the stainless-steel housing and plumbing generated a higher material contribution to the total impact for the POU AM device. For the POU RO device, the processing of polysulfone to create a membrane for use in the unit contributes to the processing phase (Figure 4.3A).

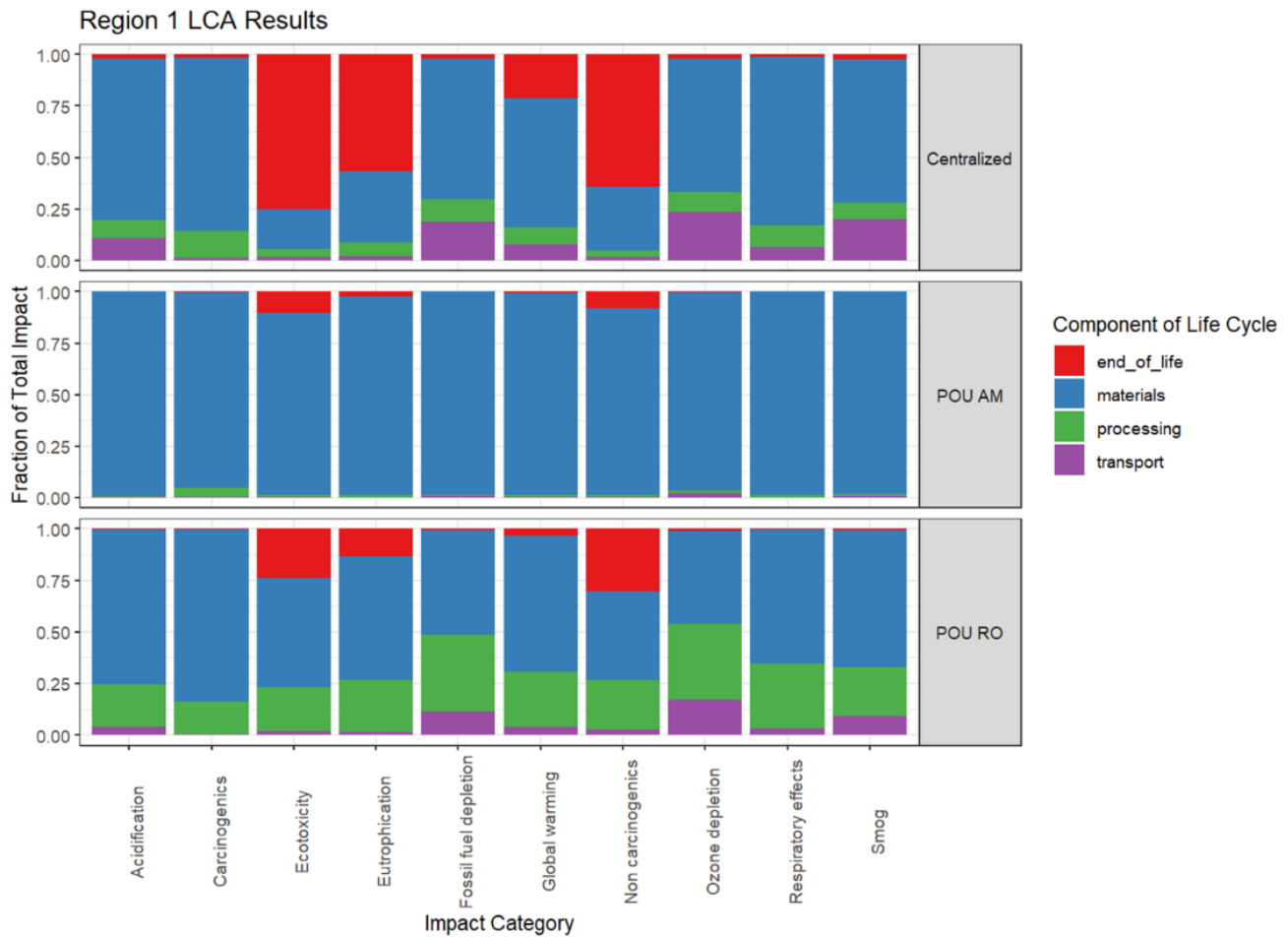

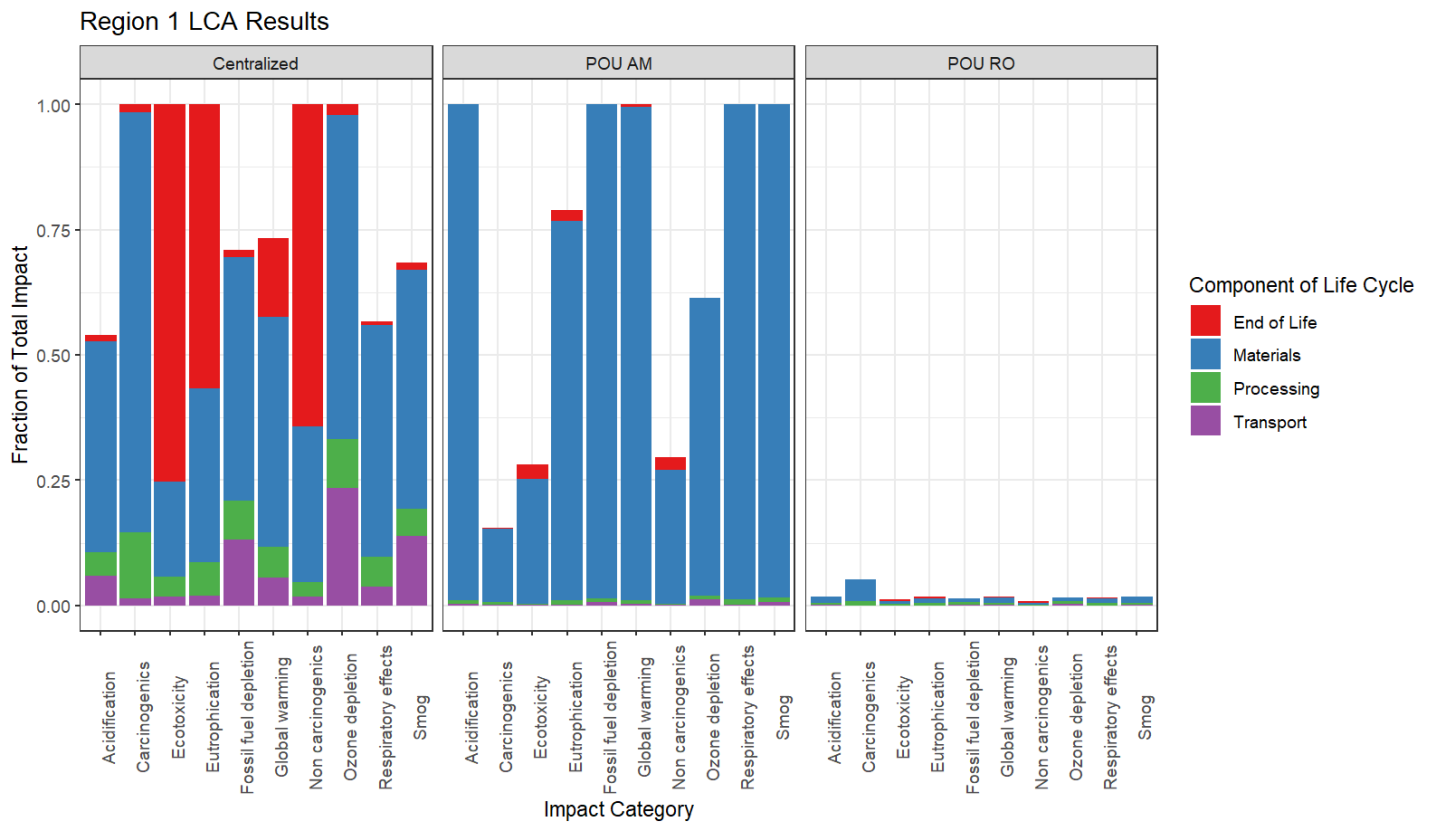

Figure 4.3: LCA Impact assessment results for Region 1. A) Relative contribution of each stage of the life cycle of a product to the overall impact; B) Comparison of the treatment options normalizing the data to the highest impact across all three alternatives.

In Figure 4.3B, we observed that the largest relative impact is associated with the ecotoxicity impact category for centralized treatment, due in part to the disposal of the adsorptive media over time. In comparison, the total relative impacts associated with ecotoxicity for both POU devices are less than half the magnitude of centralized treatment. Both the centralized treatment improvement and the POU AM Device B have 5 categories of impact where the alternative is highest. However, the relative impacts of the POU AM Device B are smaller than for the centralized improvement in the categories where POU AM Device B is not the highest impact alternative. In Region 1, the POU RO Device D has the lowest total overall impact across all impact categories. As a result, we rated the POU RO Device D with the highest score and the centralized alternative with the lowest score.

4.2.2.2 Region 5 Impact Assessment Results

In Region 5, the modeled centralized treatment improvement consisted primarily of PVC and cast-iron pump components; the fraction of the life cycle corresponding to processing is primarily driven by the processing and molding of PVC pipes and the casting of iron components (Figure 4.4A). The relative contribution from transportation is highest for POE Device N, in part due to additional components such as PVC piping, rubber spacers, etc. that need to be included in the device installation that are not

present in POE Device K. The end of life of spent adsorptive media for both POE devices contribute the most to the total impact from these devices, particularly to the ecotoxicity category. Centralized treatment has the highest impact for the carcinogenics category only, driven by the cast iron components.

POE Device K has the largest total impact overall, predominantly due to the end-of-life disposal of the adsorptive media (Figure 4.4B). POE Device K has a higher frequency of replacement than POE Device N due to a shorter useful life of the media, accounting for the difference in impact between the two devices. The centralized improvement has the lowest impact of the three alternatives; this is a result of relatively little material being needed over a 30-year period. The centralized improvement consists largely of installing additional PVC piping and a new chlorine dosing pump, both of which have an estimated useful life of 17 years (derived from the EPA Cost Models). As a result, only one replacement is necessary in the 30-year period for the components in the centralized improvement. In contrast, media within the POE devices has a useful life of 7-10 years (depending on the specific device), resulting in 3-4 full replacements within the 30-year period.

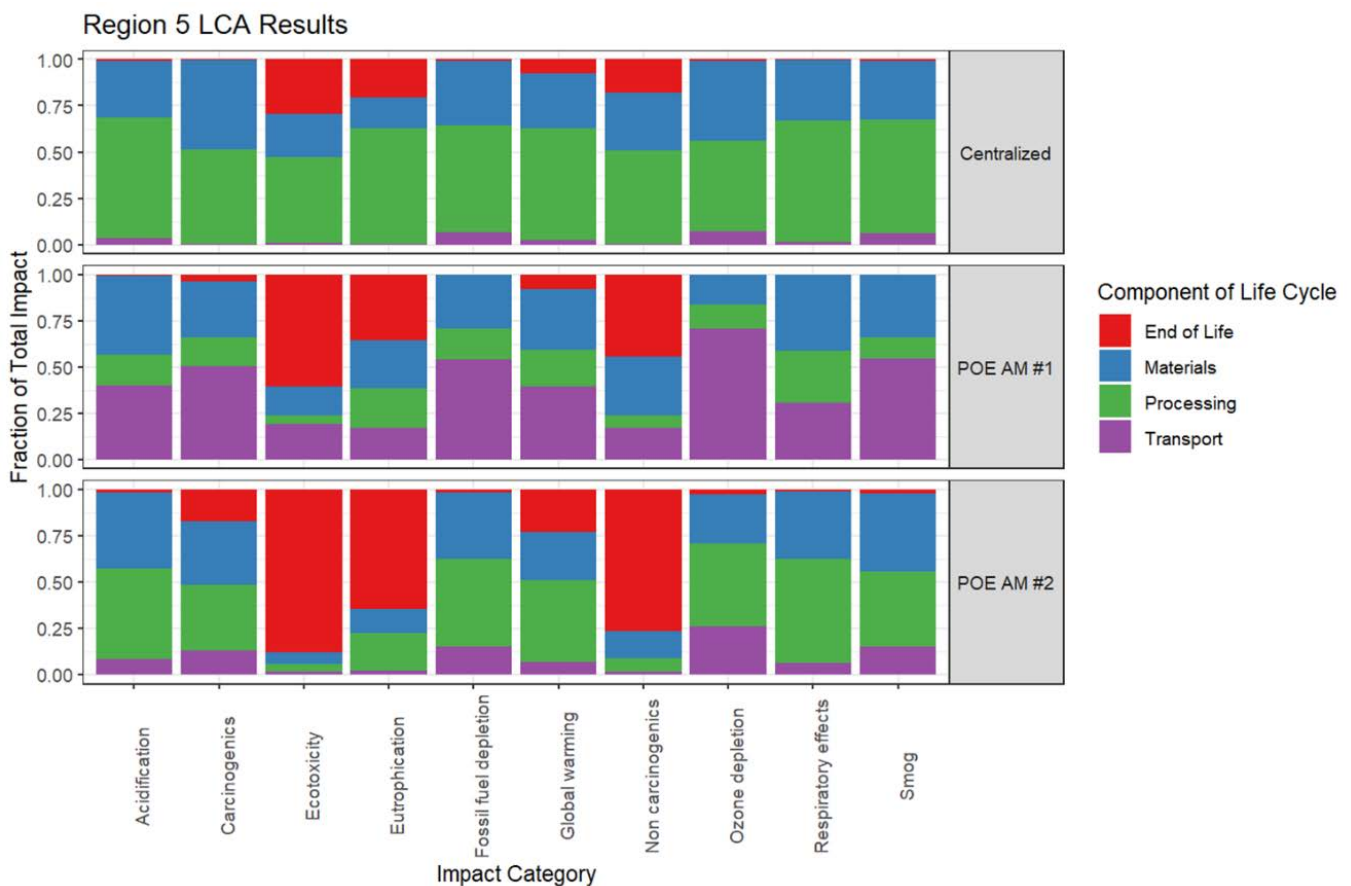

Region 5 LCA Results

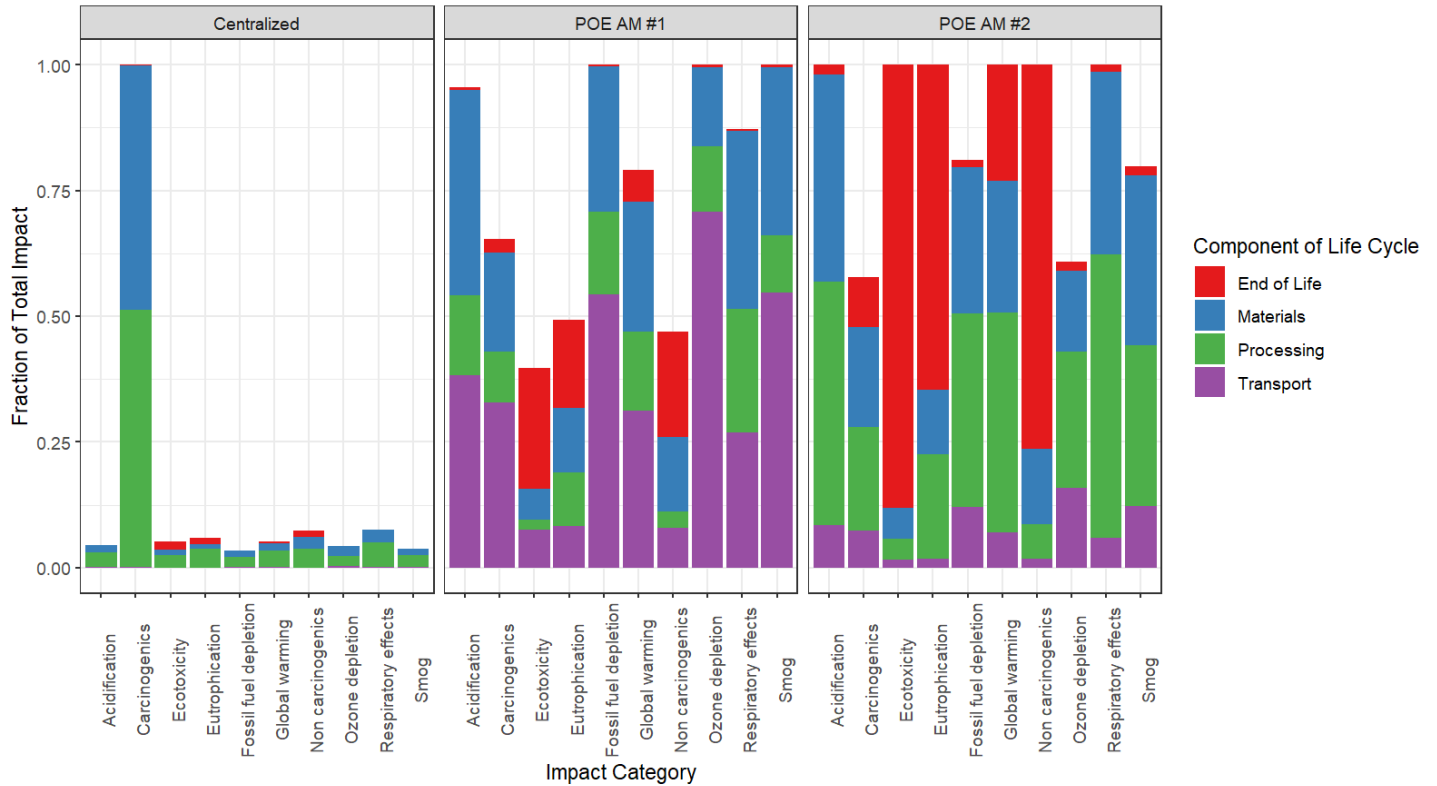
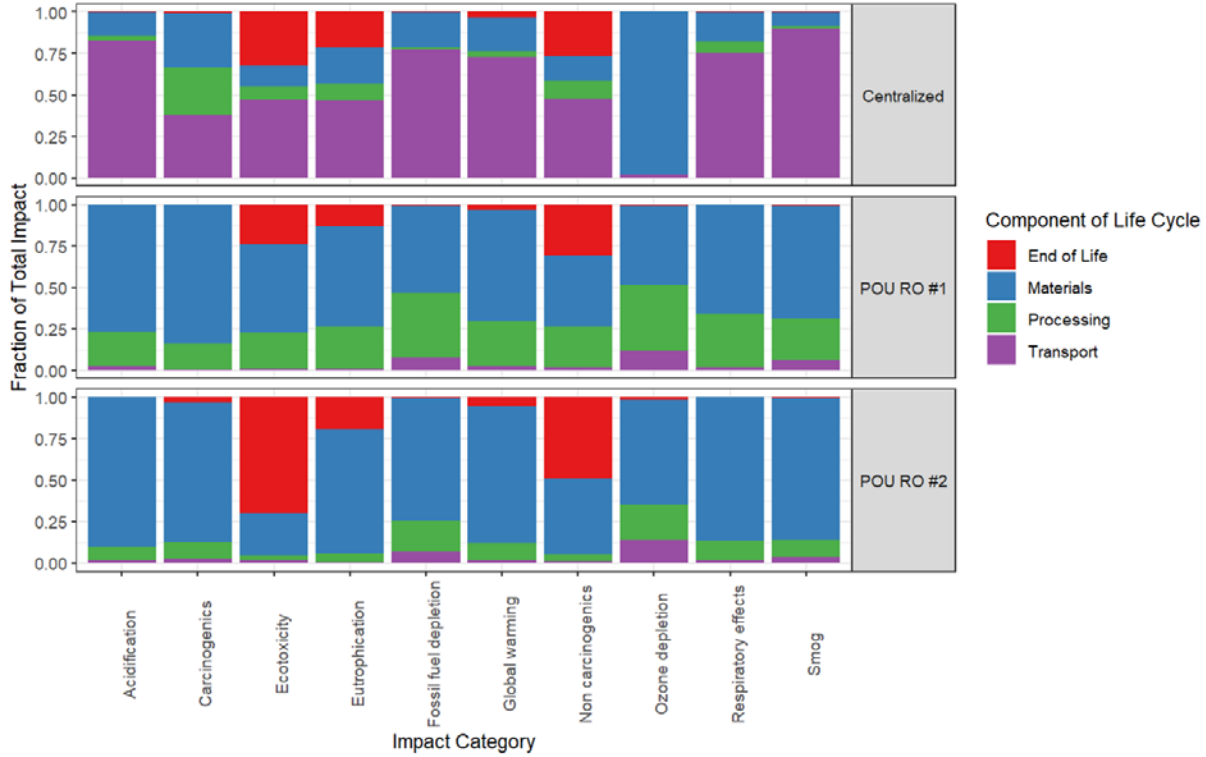

Figure 4.4: LCA Impact assessment results for Region 5. Panel (A) shows the relative contribution of each stage of the life cycle of a product to the overall impact. Panel (B) compares the alternative technologies, normalizing the data to the highest impact across all three alternatives.

4.2.2.3 Region 7 Impact Assessment Results

In Region 7, Figure 4.5A shows which phases of the life cycle the largest fraction to the total impact. For centralized treatment, transportation has a large impact on all categories with the exception of ozone depletion, driven largely by the distance needed to obtain the ion exchange resin from a manufacturer and the number of times the resin is transported to a waste disposal facility over the 30-year period. For both POU RO units, the materials phase of the life cycle is a larger fraction of the total impact, in part due to the multiple components (each RO device contains two pre-filters (GAC and polyethylene pre-sediment filters), one post filter (GAC), and a polysulfone membrane). Obtaining these raw materials contributes to all impact categories, particularly to acidification, carcinogenics, global warming, respiratory effects, and smog. We hypothesize that part of the reason these raw materials contribute to these categories specifically is due to the extraction and activation of the GAC pre- and post- filters, as the carbon component can come from the extraction of coal. We also observed that the disposal of GAC increases the end-of-life fraction of the total impact for both POU RO devices, particularly in the ecotoxicity and non-carcinogenics impact categories.

Region 7 LCA Results



Region 7 LCA Results

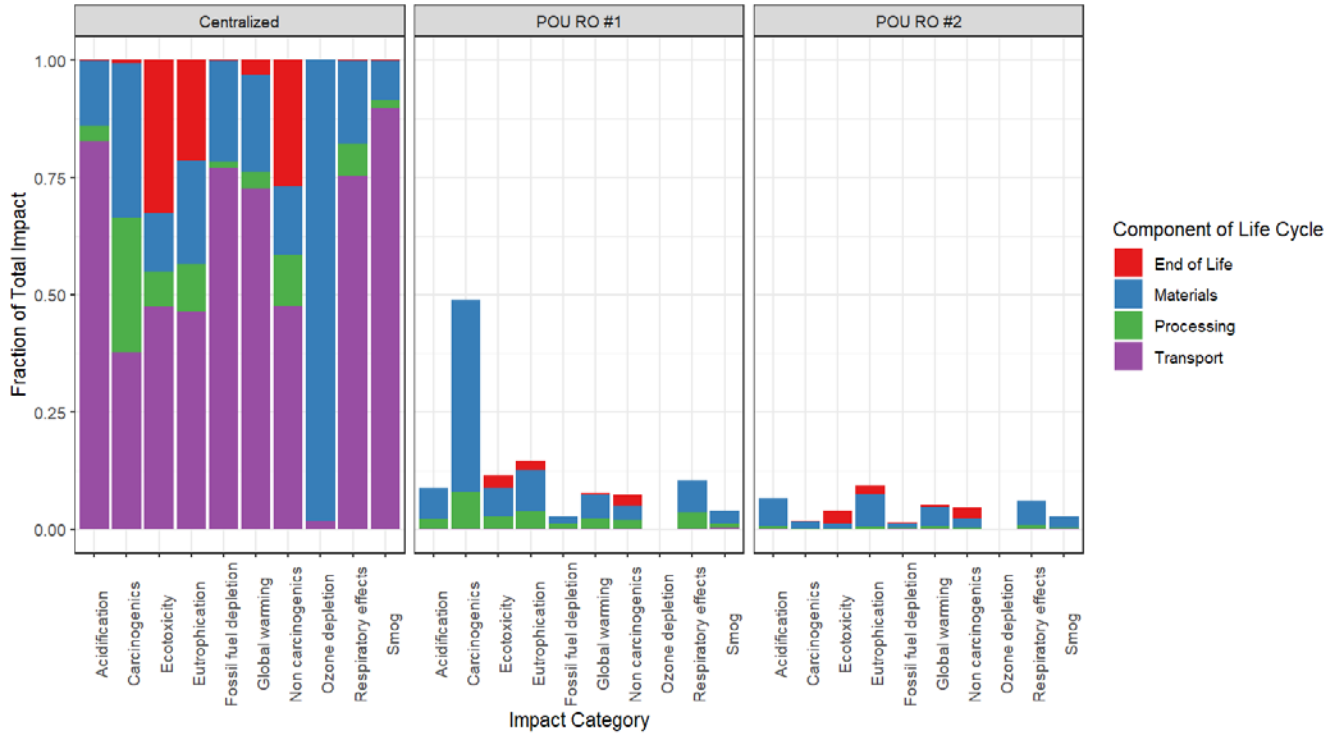

Figure 4.5: LCA Impact assessment results for Region 7. Panel (A) shows the relative contribution of each stage of the life cycle of a product to the overall impact. Panel (B) compares the alternative technologies, normalizing the data to the highest impact across all three alternatives.

Figure 4.5B shows that the centralized improvement was the largest relative impact in each impact category. The largest total impact was observed for the centralized treatment improvement in all impact categories, largely due to obtaining, processing, transporting and disposing of the ion exchange resin over time. Similarly, to the adsorptive media results obtained in Region 1 and 5, we observed that the higher frequency of replacement of the media over time contributes to the transportation and end of life phases of the life cycle. In contrast, the ecotoxicity impact category for the POU RO units is primarily due to the material and end of life components of the life cycle, due primarily to the frequent disposal of GAC pre- and post-filters. POU RO Device G has the lowest impact overall in Region 7, preferred over POU RO Device D because it contains smaller components and therefore less material.

4.2.2.4 Region 9 Impact Assessment Results

In Region 9, the materials phase of the life cycle constituted the largest fraction of the total impact for POU AM Device B (Figure 4.6A). For POU RO Device D, the total impact is a balance between all four life cycle phases, driven by the presence of several different materials. In POU AM Device B, the primary component driving the material impact is stainless steel, present in both the device housing and valve components. For centralized treatment, the transportation phase of the LCA makes up a large component of the total impact largely due to the remoteness of the CWS, which is on average 60 miles from manufacturing and processing facilities and 120 miles from the nearest municipal solid waste disposal location, approximately 2-4 times the distance to a processing facility in the other three regions and 8-12 times the distance to a solid waste disposal facility in the other three regions. As a result, disposal, including transportation to disposal facilities drives the total impact along with the 7–10-year useful life of ion exchange resin.

Region 9 LCA Results

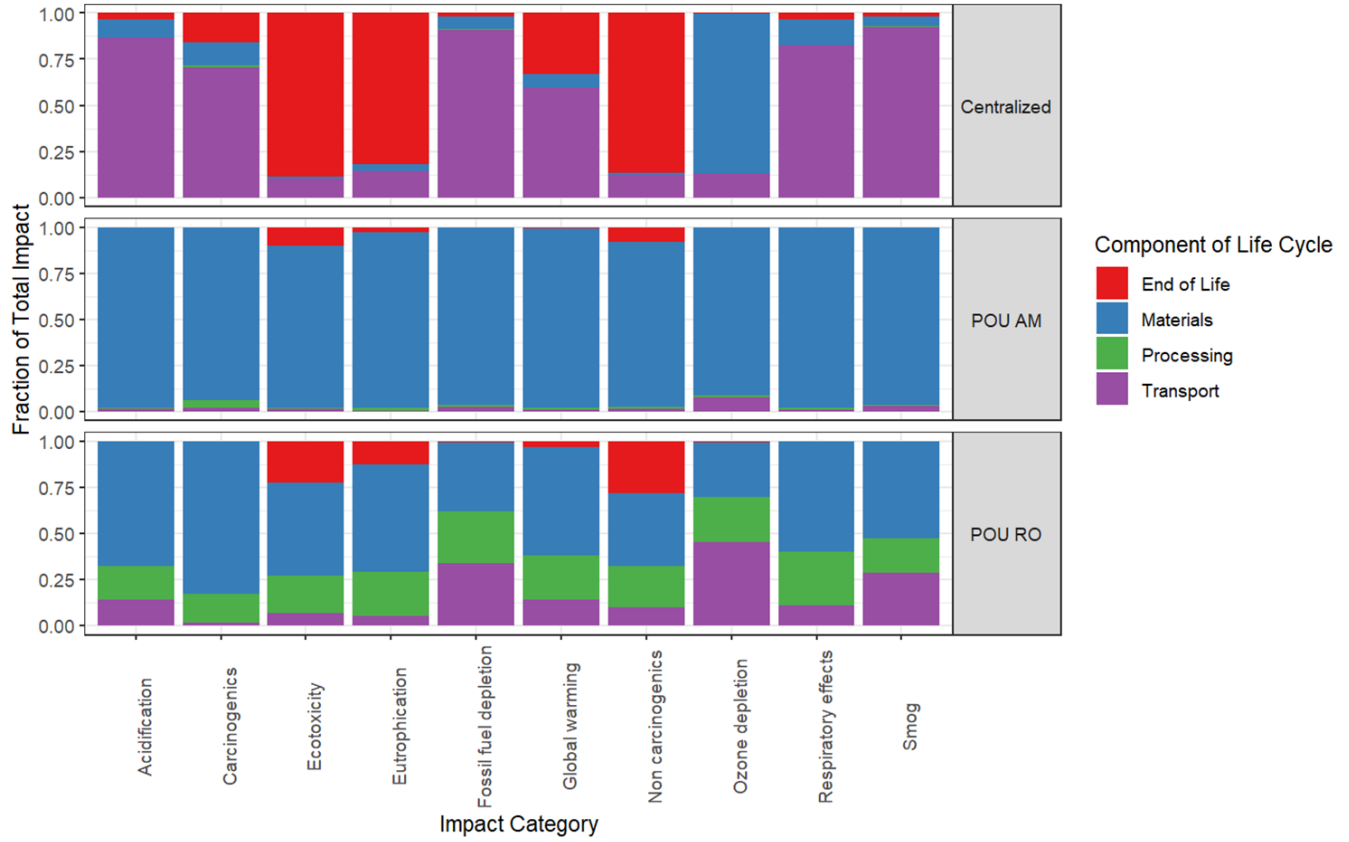

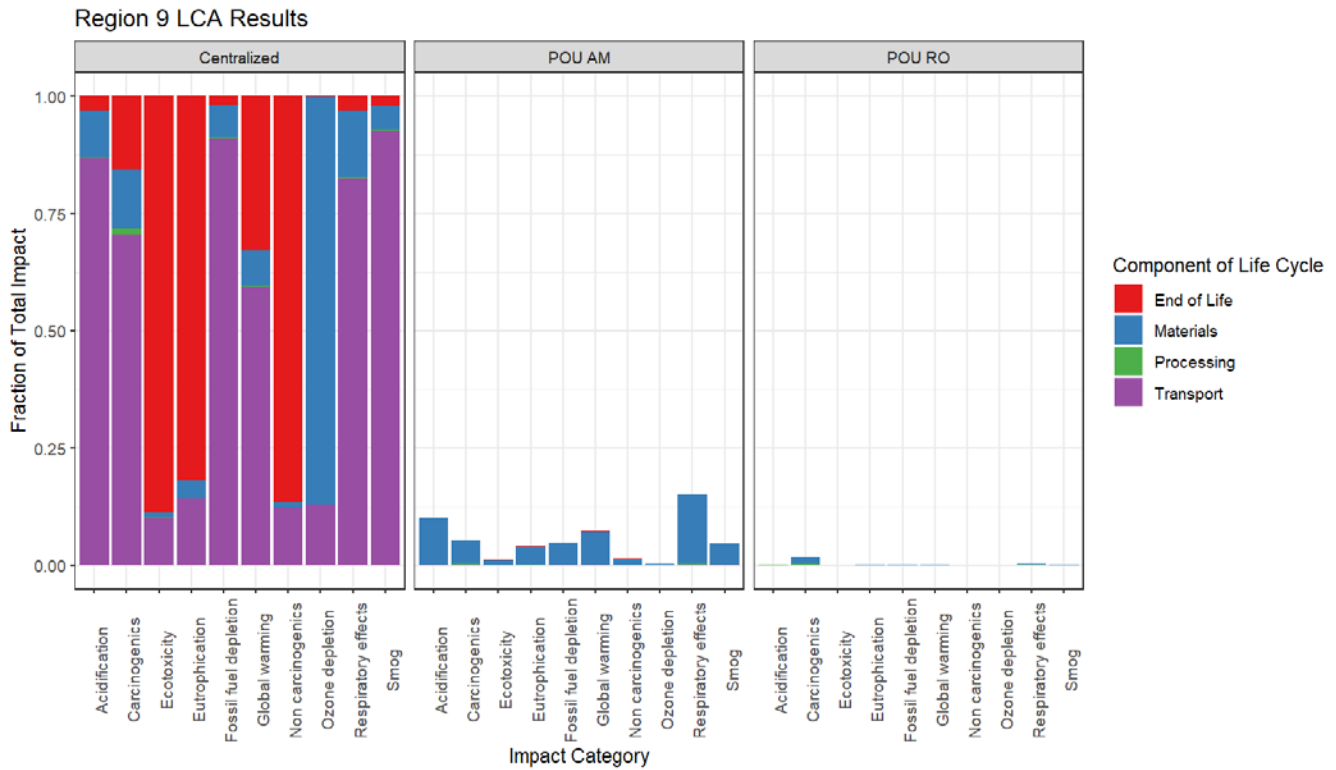

Figure 4.6: LCA Impact assessment results for Region 9. Panel (A) shows the relative contribution of each stage of the life cycle of a product to the overall impact. Panel (B) compares the alternative technologies, normalizing the data to the highest impact across all three alternatives.

Figure 4.6B revealed the centralized treatment improvement has the largest total relative impact, across all impact categories. Compared to the total impact from the centralized treatment facility, the impact from both POU devices is very small, less than 25% of the total impact from centralized treatment in each impact category. The POU RO device has the lowest total impact of the three alternatives. The POU AM device, as was found in Region 1, has a higher overall impact than the RO device due to the disposal and raw materials associated with the adsorptive media.

4.2.2.5 Summary of LCA impact assessment results

Figure 4.7 provides a summary of each treatment option in each of the four regions, including comparing life cycle phases across phases regions and treatment options (panel A) and the total relative impact normalized within each region (Panel B).

LCA Results

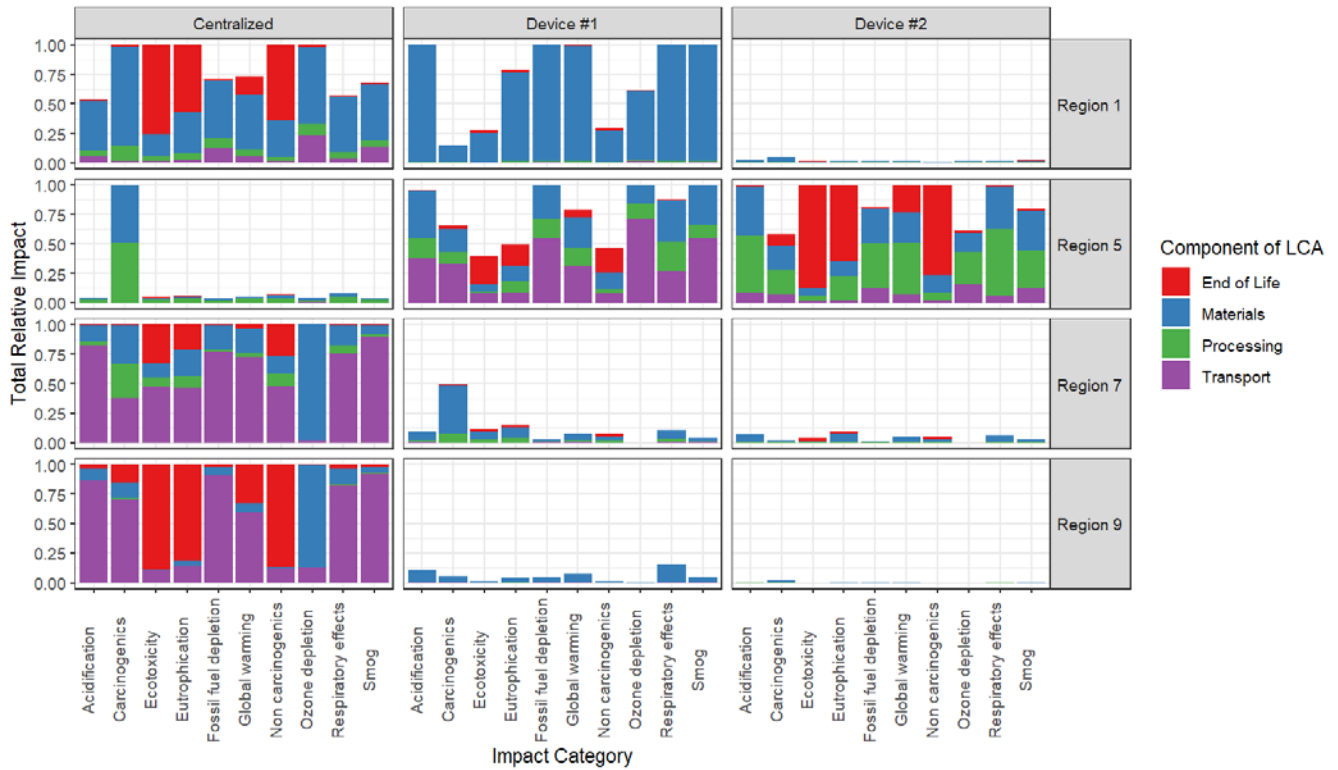
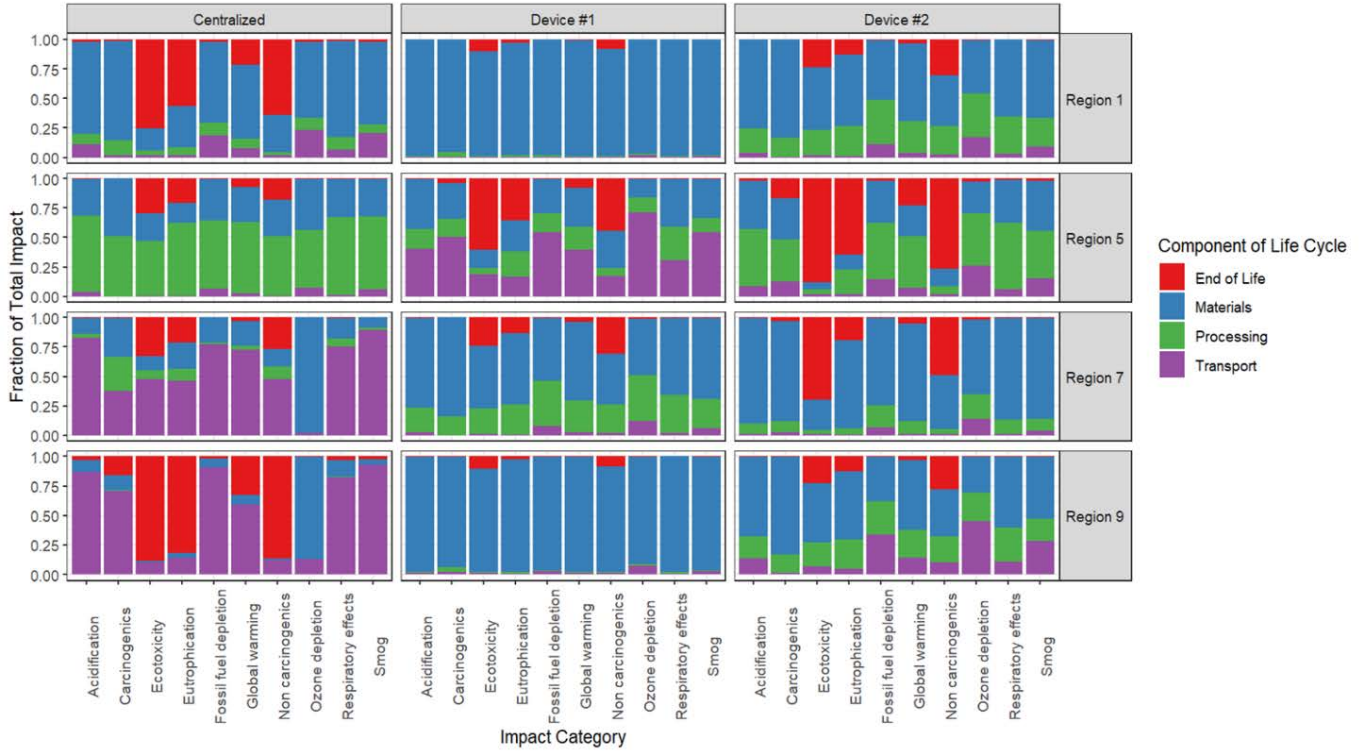

Figure 4.7: Comparison of LCA impact assessments across all four case studies. Panel (A) shows the relative contribution of each stage of the life cycle of a product to the overall impact. Panel (B) compares the alternative technologies, normalizing the data to the highest impact across all three alternatives.

The impact assessment revealed the following conclusions in each Region: the POU RO unit (Device D) selected in both Regions 1 and 9 had the lowest total relative impact compared to the POU AM device and the individual centralized improvements, the centralized alternative had the lowest total relative impact in Region 5, and POU RO Device G had the lowest total relative impact in Region 7. Conversely, centralized treatment alternatives had the highest total relative impact in Regions 1, 7 and 9. In Region 5, POE Device K had the highest total relative impact, driven by the frequency of replacement of the adsorptive media. Table 4.6 summarizes these results, scoring the alternative with the lowest impact with three points and the alternative with the highest impact with one point.

Table 4.6: Summary and ranking of the LCA impact assessment results in each CWS.

Region	Technology	Metric
		LCA (Smallest Impact)
		3 = Best Option, 2 = 2 nd Best Option, 1 = 3 rd Best Option
1	Centralized Upgrade	1
	POU AM Device B	2
	POU RO Device D	3
5	Centralized Upgrade	3
	POE AM Device N	2
	POE AM Device K	1
7	Centralized Upgrade	1
	POU RO Device D	2
	POU RO Device G	3
9	Centralized Upgrade	1
	POU AM Device B	2
	POU RO Device D	3

5 – Life Cycle Costing (LCC)

5.1 Methods

The cost of each treatment improvement was quantified using the EPA WBS Cost Model equations and unit costs for individual technologies over 30 years (USEPA, 2021a). EPA cost model assumptions were modified to accurately reflect the components present in each selected treatment option, with both one-time costs (capital costs such as installation) and ongoing costs (such as filter cartridge replacement) accounted for. Results are presented both as total costs and costs per household, similar to the functional unit used in the LCA. A comparison of the cost methodology presented in this study in comparison to past studies is presented in Appendix E for reference.

5.1.1 EPA Cost Models

We used components of the EPA work-based structure cost models for centralized treatment technologies and for POU/POE devices for cost modeling for small systems (USE EPA, 2021a) (Figure 5.1). Using components from each model, we estimated the life cycle cost (LCC) over 30 years using data from: (1) the default assumptions in each model to size the system design (flow rate), (2) values determined through conversations with CWS stakeholders where existing infrastructure was already in place (Region 1 and Region 5), (3) replacement frequencies and component costs of POU/POE devices, and (4) values from literature and previous case studies where the CWS stakeholders could not provide a specific value or where the improvement involved the installation of a new centralized treatment technology (Region 7 and 9). To accurately estimate costs for each CWS, we made the assumptions and decisions described below when using the models.

In the POU/POE cost model, we determined the capital cost of a unit by consulting manufacturers for hardware costs, replacement frequencies, and replacement component costs for each device. We used the number of connections in a CWS as the input for the number of households and estimated both the average daily flow and max daily flow where possible from data provided from the community. In the centralized cost models for the upgrade, each CWS had a treatment facility building already built in the community with adequate footprint to house a treatment improvement; therefore, we excluded the cost of construction of a facility from the centralized cost models.

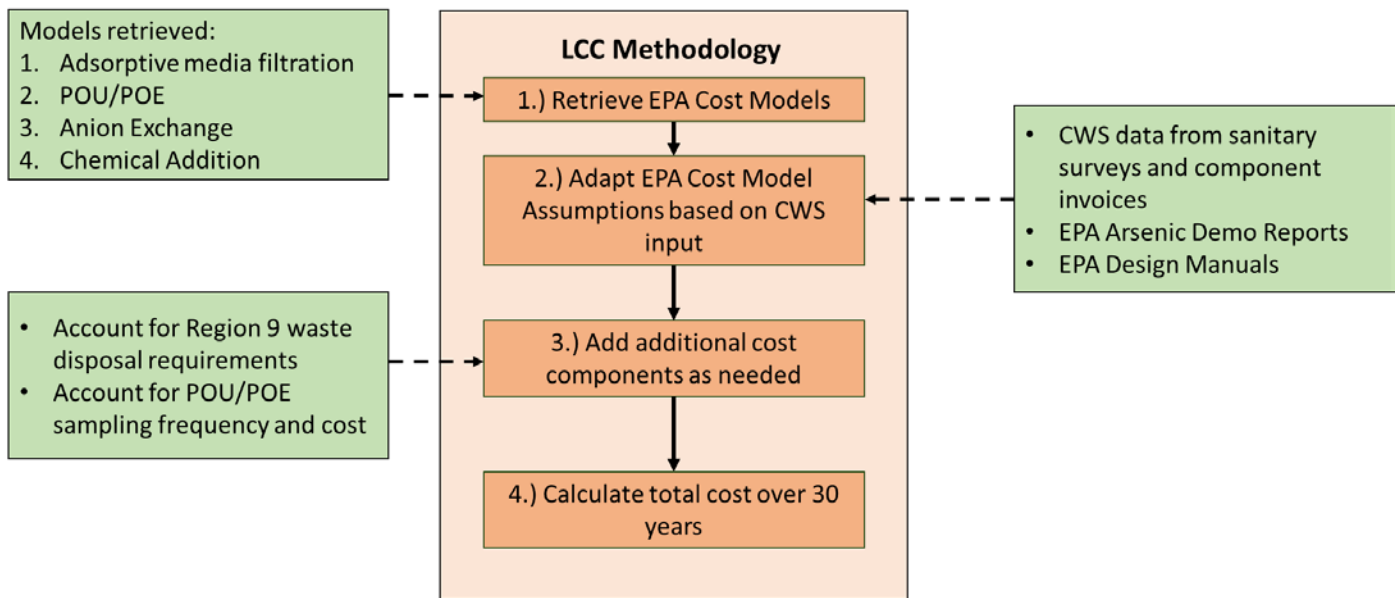

Figure 5.1: Methodology (shown in orange) and data inputs (shown in green) to calculate life cycle cost over a 30-year period.

Using estimates from stakeholder engagement and literature, we generated results for centralized treatment upgrades for each CWS. Cost information was extracted from the Output sheet of each EPA Cost model after running the model with a set of data. We extracted the following information from each model: (1) the component material, (2) the size of the component, (3) the number of components, (4) the unit cost of each component and (5) the useful life of the component. The process flow schematics (Appendix A) were used to extract the relevant information from the EPA cost model output to populate a cost inventory (similar to the procedure in Section 5 for LCA). From this inventory, we calculated the total capital cost (including both direct, indirect, and add-on costs), and annual operation and maintenance costs (O&M) for each set of design assumptions.

We used the useful life information provided in the EPA Cost Models to determine the number of replacements necessary over 30 years by dividing the useful life by thirty years and rounding down to the nearest whole number. For POU/POE devices, we relied upon communication with manufacturers to determine the useful life of POU/POE device components since replacement of specific components such as filter cartridges is more frequent (1-3 years) compared to centralized treatment components lifetimes (10-20 years). Based on the number of replacements, we then adjusted the total cost of each component prior to calculating total capital and O&M costs. For yearly costs such as labor and chemical costs, we multiplied the yearly cost by 30 years to obtain the total cost over 30 years to avoid double counting the first year of labor.

Table 5.1 shows which values were extracted from the EPA cost models and which values we calculated to find the total cost over 30 years. These calculations do not consider interest over time and provide example calculations only, not actual values used to estimate cost in subsequent figures (full details are provided in the Appendix).

Table 5.1: Values extracted from EPA cost models were used to calculate the number of replacements over a 30-year period. Values extracted from the EPA cost model are shown on the left in yellow and calculated values are shown in green on the right of the table.

Values extracted from EPA Cost Model					Calculated values		
Cost Component	Number of Units [unitless]	Unit Cost [\$]	Component Cost [\$]	Useful Life [years]	Number of full replacements in 30 years [replacements]	Number of multiples to include [unitless]	Cost over 30 years [\$]
Example Component	a	B	$C = a * B$	x	$r = 30/x$	$R = 1$ [initial installation] + $\text{ROUNDDOWN}(r)$	$R * C$
Process Valve	2 units	\$45.00	= 2 units * \$45 = \$90	17 years	30/17 years [useful life] = 1.76	= 1 + $\text{ROUNDDOWN}(1.76) = 2$	= 2 * 90 = \$180
Operator Labor	60 hours/year	\$30/hour	\$1800/year	1 year	30/1 year = 30 years	= 30 years (this was manually adjusted to avoid double counting the first year)	= 30 * \$1800 = \$54,000

5.1.2 Data inputs

5.1.2.1 Community data

We consulted stakeholders from each CWS to adjust the assumptions made in the EPA cost models to more accurately reflect state policies, community characteristics, and additional factors influencing costs. We presented the current list of model assumptions from the EPA cost models to each CWS's stakeholders and discussed how each assumption could be modified if necessary. Then, the assumptions from each CWS were used to iterate through the EPA cost model under different scenarios: POU RO device, POU adsorptive media device, model by number of households, model by flow rate, etc.

5.1.2.2 Literature data

To fill any gaps in the EPA cost models, we consulted previously conducted LCC studies from literature, previous EPA studies such as the Arsenic Treatment Demonstration project, and the EPA design manuals for specific treatment technologies. Data and assumption sources have been noted where applicable.

5.1.3 Modeling best and worst-case cost

Through conversations with POU/POE manufacturers and CWS stakeholders, we determined that including a range of cost estimates in our analysis was important. For example, we learned that, often, POU/POE devices were observed to need frequent component replacement and that replacing components in private households can be challenging, especially in light of social distancing during the COVID-19 pandemic. In addition, we learned from manufacturers the quality of water entering the POU/POE device has a large impact on device performance. For example, while a POU device may remove 95% of pentavalent arsenic at a pH of 7.5, this can be influenced by sulfate, iron, and total solids content of the influent water. As a result, we determined a set of best- and worst-case assumptions to model both low and high-cost estimates respectively.

First, where possible, we used CWS-specific information for best- and worst-case scenario values. Best-case scenarios used manufacturer and design standards for both POU/POE and centralized treatment upgrades and represent the ideal scenario (water quality in source water, operational practices, technology performance) for technology installation and operation. Worst-case scenarios integrated evidence from previous POU/POE and centralized treatment installation case studies and feedback from CWS stakeholders. For example, we learned from a conversation with a stakeholder in Region 7 that travel time in rural areas of Nebraska can significantly increase the labor costs of maintenance activities for POU/POE and centralized systems, and the time to sample POU/POE units for compliance purposes. CWS stakeholders in Region 9 also highlighted the importance of waste disposal per California state regulations; therefore, specific cost considerations related to residuals management were adjusted based on these requirements recommendations from Region 9 stakeholders.

For input data generated from literature, the best-case scenario was constructed by selecting the smallest values from literature or from each community water system assumptions as the assumptions for each of the cost component from the EPA Cost Model. The best-case represents the scenario where labor requirements are minimized, lab analysis is reduced after the first year as a result of adequate contaminant removal, operation and maintenance times are limited to only necessary activities and replacement frequencies are decreased by increasing the useful life of the components. The worst-case scenario was constructed by selecting the largest values from literature or from each community water system assumptions. The worst-case scenario represents an increase in the labor costs, an increase in the number of hours per year spent on operations and maintenance activities, no reduced compliance sampling after the first year and replacement frequencies are increased by decreasing the useful life of components. Because many of these best-case and worst-case values were primarily generated from literature, the assumptions may be smaller or larger than the CWS-specific assumptions which leads to a non-intuitive decrease in cost in the worst-case assumptions.

5.2 Results

5.2.1 Cost Assumptions

5.2.1.1 Centralized treatment improvements

We estimated the cost of centralized improvements using the EPA Cost Models for adsorptive media (for Region 1), chemical addition (Region 5), and anion exchange (for Region 7, Region 9) as a baseline to inventory components necessary to life cycle costing. In Region 1, we used the EPA Adsorptive media cost model default assumptions to generate a baseline inventory for an adsorptive media system including 2 filtration vessels and a backwash system (USEPA, 2021c).

In Region 5, we reviewed an inventory report provided by the CWS to create an inventory of current system components. In addition, we reviewed other EPA cost models specific to chemical addition (such as phosphate addition), since a pre-chlorination cost model is not yet publicly available and used these to generate a list of potential components to include in the centralized upgrade. In addition, since no EPA cost model was available, we relied on literature from the EPA Arsenic Demo Reports, manufacturer websites, and past project invoices where possible to collect cost information.

In Regions 7 and 9, we relied primarily on the EPA Anion Exchange cost model since there is little existing centralized infrastructure in place in either CWSs. In Region 7 we chose a nitrate selective resin and based the design parameters on the EPA Design Manual for Nitrate Removal by ion Exchange (USEPA, 1978) and the WBS documentation for the anion exchange cost model (USEPA, 2017b). We selected a residuals management strategy of piping liquid waste streams to a centralized wastewater facility and a fully automated system in Region 7. We calculated the number of bed volumes using the sulfate concentration in the groundwater in Region 7 and the following relationship from the EPA WBS Cost model:

$$BV = -606 * \ln x + 3150$$

Where BV represents the number of bed volumes before regeneration, and x represents the sulfate concentration in the groundwater source (USEPA, 2017b). This yielded a BV value of 1052 BVs for Region 7 and a value of 1366 BVs for Region 9. In Region 9, we selected a strong base polyacrylic resin, a fully automated system and residuals discharge to an evaporative pond based on feedback from CWS stakeholders.

3.4.2 POU/POE Devices

As with the centralized treatment improvement, we adjusted the EPA Cost Model assumptions for POU/POE devices to be specific to each case study's context. The EPA POU/POE cost model consists of both standardized models (with assumptions about flow rates based on household size), and user defined models wherein assumptions can be adjusted to suite a specific community.

In Region 1, state-level stakeholders suggested the following adjustments to the EPA POU Cost model assumptions: decreased printing and distribution of public education materials to reflect virtual means

of communication, increased labor costs corresponding to state specific wage requirements, increased monitoring frequency for initial monitoring, increased cost per arsenic sample analysis, and consolidated maintenance and operational activities. These changes resulted in higher costs for lab analysis, materials and initial monitoring costs than the standard EPA model, but lower labor costs. In Region 5, CWS stakeholders indicated the EPA standard model assumptions were likely the best assumptions for the community. Few POE or POU installations have been completed in Illinois and thus there is relatively little evidence from past experiences with POE and POU devices. In Region 7, CWS stakeholders did indicate the time to complete both sampling and maintenance needed to be increased to reflect the amount of travel time necessary to reach rural communities with POU/POE installations; they also noted that the cost of POU devices in the past has been highly variable and specific to each community. In Region 9, we consulted previous POU studies and state level administrators and learned California has a very intensive initial public education program to encourage 100% participation in POU/POE installations. In addition, depending on the system, the California sampling requirements for compliance are higher than other states, in part because California allows systems to begin piloting prior to 100% installation. Previous case studies from California have sampled in each house 2-4 times a year compared to once a year specifically due to the nature of the contaminant in the system (for example, acute exposure to elevated levels of nitrate). The assumptions in Table 5.2 reflect these higher public education costs, including more public meetings, flyers, and outreach materials and labor from clerical staff to prepare materials. These assumptions are summarized in Table 5.1 from each CWS in comparison to the standard EPA Cost Model assumptions. Where appropriate, we also included values from a 2020 California white paper based on previously installed POU/POE devices (California Water Boards, 2020).

Table 5.2: Assumptions used to model cost using the EPA POU/POE Cost Model. The assumptions presented in this table do not include individual POU/POE device components as these components are device specific.

Category	Sub-Category	Parameter	Units	Default Value in EPA Model	CA 2020 Paper Assumptions	NH Assumptions (Region 1)	IL Assumptions (Region 5)	NE Assumptions (Region 7)	CA Assumptions (Region 9)
Initial Equipment Costs	Initial Equipment Costs	Wage rate for installation specialist (plumber/electrician)	\$/hour	\$33.12	\$33.12*	\$24.49	\$33.12*	\$33.12*	\$100
		Wage rate for system technical and maintenance labor	\$/hour	\$25.07	\$25.07*	\$21.01	\$25.07*	\$25.07*	\$57
		Wage rate for scheduling and administrative labor	\$/hour	\$17.89	\$17.89*	\$10.95	\$17.89*	\$17.89*	\$37
		POU/POE installation time	Hours/household	2	4	2*	2*	4	5

		POU/POE installation scheduling time	Hours/household	0.5	2	0.5	0.5*	2	2
Initial Educational Costs	Technical Labor to Support Educational Program	Develop technical education materials	Total hours	10	10*	0	10*	10*	0.25
		Prepare for and attend public meetings	Total hours	2	2*	2*	2*	2*	7.2
		Post-meeting stakeholder communication	Total hours	2	2*	2*	2*	2*	2.75
	Clerical Labor to Support Educational Program	Prepare educational materials for distribution	Total hours	6	6*	0	6*	6*	6*
		Prepare for and attend public meetings	Total hours	2	2*	2*	2*	2*	2*
		Prepare post-meeting materials for distribution	Total hours	2	2*	0	2*	2*	2*
	Communication for Materials for Educational Program	Print flyers announcing public meetings	Flyers	10	10*	0	10*	10*	3
		Cost per flyer for printing	\$/flyer	\$2.00	\$2.00*	0	\$2.00*	\$2*	\$2*
		Buy ads to announce public meetings	Ads	0	0*	0*	0*	0*	\$10
		Cost per meeting ad	\$/ad	\$40	\$40*	0	\$40*	\$40*	\$40*
		Print handouts for meetings	Pages/household	3/house	3/house*	0	3/house*	3/house*	3*
		Print inserts for billing mailers	Pages/household	1/house	1/house*	0	1/house*	1/house*	2
		Cost to print handouts and mailers	\$/page	\$0.08	\$0.08*	0	\$0.08*	\$0.08*	\$1.50
Initial Monitoring Costs	Initial Monitoring Costs (First year only)	Time to take sample during first year	Hours/sample	0.25	0.25*	0.25*	0.25*	0.25*	1
		Time to schedule sample event at household	Hours/sample	1	0*	0	1*	1*	2
		Number of samples per household during the first year	Samples/household	1	1*	1*	1*	1*	4
		Fraction of households sampled during the first year	% households	100	100*	100*	100*	100*	100*

		Laboratory analysis fee	\$/sample	\$25.75 (arsenic) / \$24.25 (nitrate)	\$25.75 (arsenic) / \$24.25 (nitrate)*	\$30 (arsenic)	\$25.75 (arsenic)*	\$16-19 per nitrate	\$30 per sample
		Sample shipping cost (bulk)	\$/bulk shipment	\$9 for 15 samples	\$9 for 15 samples*	0	\$9 for 15 samples*	\$9 for 15 samples*	\$9 for 15 samples*
Indirect Capital Costs	Indirect Capital Costs	Cost to obtain operating permit	\$/% of installed equipment cost	3	3*	0	3*	3*	3*
		Cost to conduct pilot study	\$/% of installed equipment cost	3	3*	0	3*	3*	3*
		Cost for legal activities	\$/% of installed equipment cost	3	3*	3*	3*	3*	3*
		Cost for engineering activities (device selection)	\$/% of installed equipment cost	15	15*	0	15*	15*	15*
		Contingency cost (unknown factors)	\$/% of installed equipment cost	10	10*	10*	10*	10*	10*

*Assumption from the state stakeholder is the same as the EPA Cost Model

We then calculated the total cost per household over 30 years for each POU/POE device using the corresponding assumptions (Table 5.2, Figure 5.2). In Figure 5.2, we present the results from running the EPA cost model for a generic NSF/ANSI 53 certified device removing arsenic under different assumptions, including A) the total cost over 30 years as a portion of the total cost to highlight which elements contribute most to the total cost under different cost assumptions; 2) the total cost over 30 years for each set of assumptions. The results highlight the importance of understanding the true time commitment and cost to operate and maintain POU/POE devices in each CWS. For example, using the California cost assumptions, labor costs are higher as a result of a higher operator wage and increased time to complete O&M activities in California due to the geographically remote location of the community.

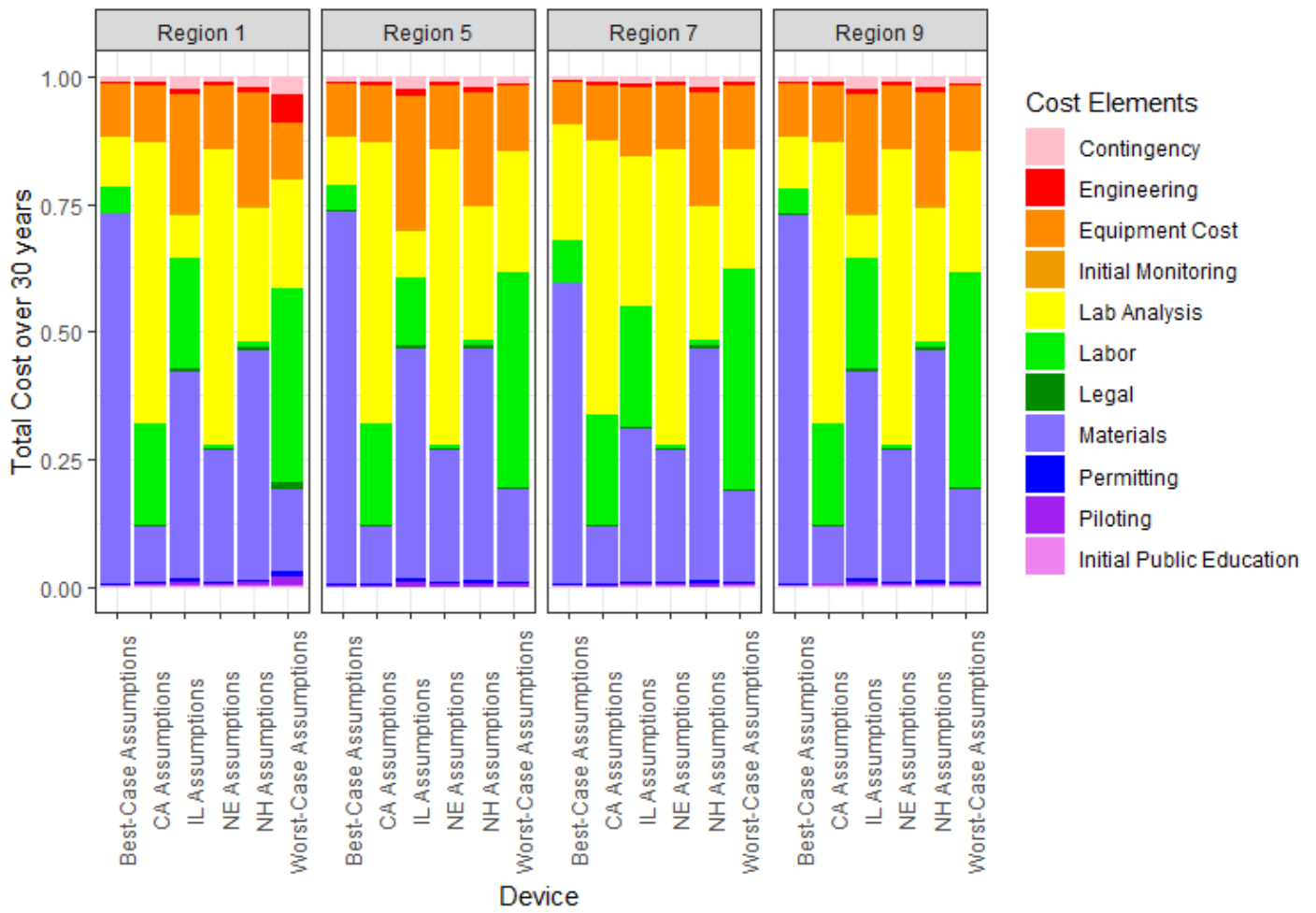

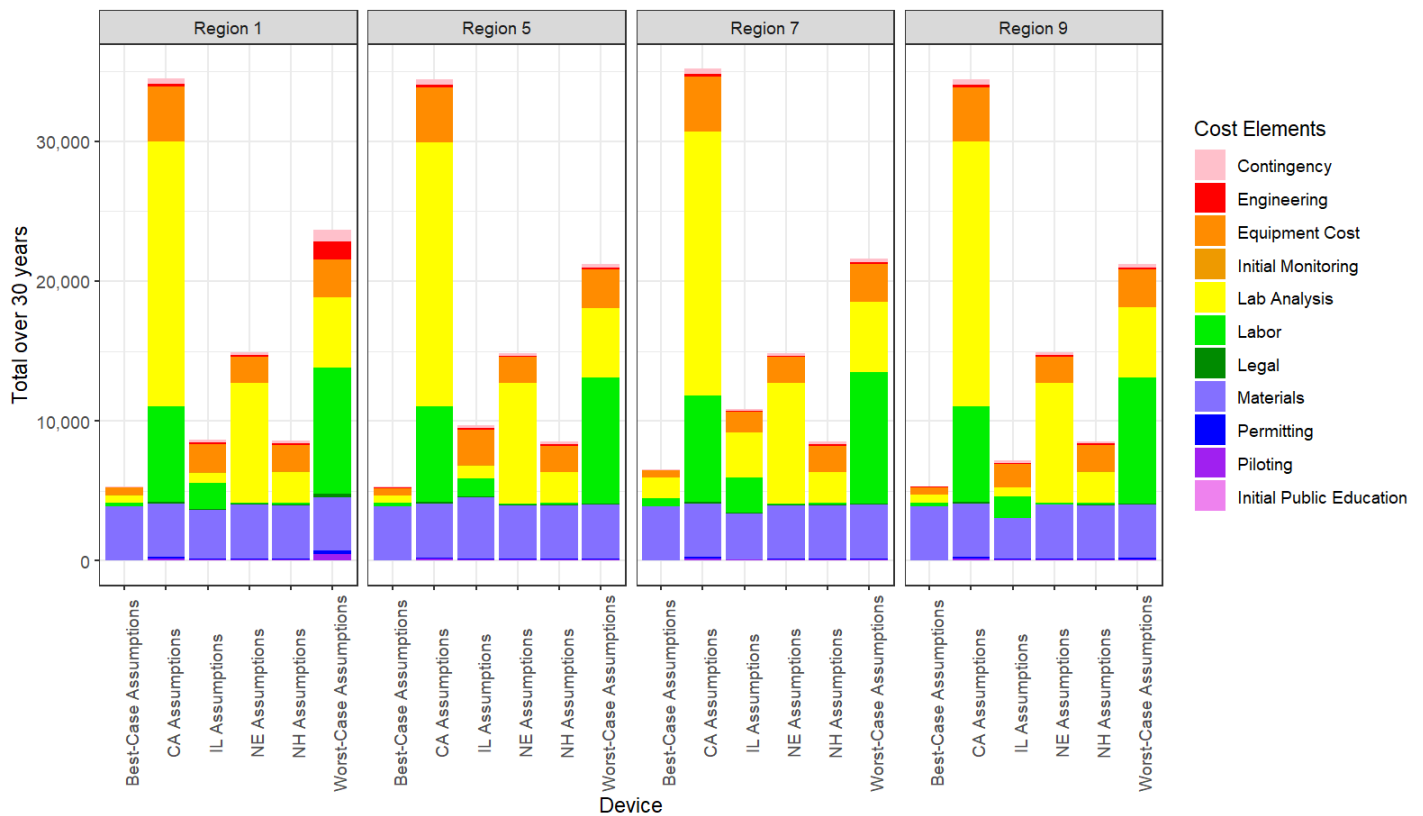

Figure 5.2: A) Total cost over 30 years normalized per household for each set of assumptions used in the POU/POE Cost Models; B) Total cost over 30 years in USD. The results represent a generic POU AM device certified to NSF/ANSI 53 found in the EPA Cost models to show how the difference in assumptions impact cost based on the population served.

Labor and lab analysis are particularly important elements contributing to overall cost when installing POU/POE devices in a CWS (Figure 5.2). California and worst-case assumptions had higher wages for staff, more required samples to be tested, more expensive lab analysis costs, and more staff hours than the other set of assumptions, accounting in part for the large lab analysis cost. In New Hampshire or with best-case assumptions, materials such as POU filter replacement components make up a large portion of the total cost, reflecting a higher replacement frequency of components but lower costs of labor and lab analysis components, while engineering, contingency, initial public education, legal, permitting, piloting and initial monitoring costs are minimal for all the sets of assumptions. The largest portions of costs across all systems are labor, materials, equipment cost and lab analysis. Because these elements constitute O&M costs, we see that O&M costs make up the largest portion of the costs associated with POU/POE devices over 30 years, as anticipated.

5.2.2 Cost Results

The following cost results represent the total cost over 30-years per household in each CWS. A table and figure for each CWS shows the total direct, indirect, and O&M costs over 30 –years per household. Total direct costs consist of equipment costs, initial monitoring costs and initial public education costs.

Total indirect costs consist of permitting, piloting, contingency, engineering and legal and administrative costs. Total O&M costs consist of lab analysis costs, materials costs (replacement components) and labor costs.

5.2.2.1 Region 1 Cost Results

In Region 1, the centralized treatment improvement had the highest per household total direct and total indirect cost over 30 years. The POU carbon fiber adsorptive media had the lowest overall cost; the total direct cost of the adsorptive media device is larger than the RO device, however, the replacement frequency and number of components in the RO system make the O&M costs of the RO device larger over time. The total cost per household of the POU devices are within \$900 of each other over 30 years within O&M costs being the differentiating cost component. Indirect costs over 30 years are smaller for both POU devices compared to centralized treatment.

Table 5.3: Summary of primary costs per household over 30 years in Region 1

Total cost (\$) per household over 30 years			
Improvement	Total Direct	Total Indirect	Total O&M
Central Upgrade	1,953	1,398	8,880
POU AM Device B	2,550	277	4,817
POU RO Device D	1,962	215	5,568

Equipment and material costs make up more of the total per household cost for both POU options (Figure 5.3). This is due in part to the high frequency of replacement components needed for the POU's compared to replacement needs for the centralized treatment upgrade. In addition, lab analysis accounts for much of the total POU cost over 30 years, resulting from monitoring requirements for compliance when using POU's for regulatory compliance in CWSs. For example, in Region 1, in the first year, a sample must be taken at least once in each home for compliance purposes (24 samples in year one). While in some states, after the first year, sampling frequency can be reduced to a fraction of the total houses if contaminant removal is satisfactory in the first year; however, in Region 1, sampling frequency must remain at 100% of the homes over time. Conversations with state administrators revealed that approval for reducing sampling frequency would not likely be reduced because the contaminant is arsenic and because the community only consists of 24 households.

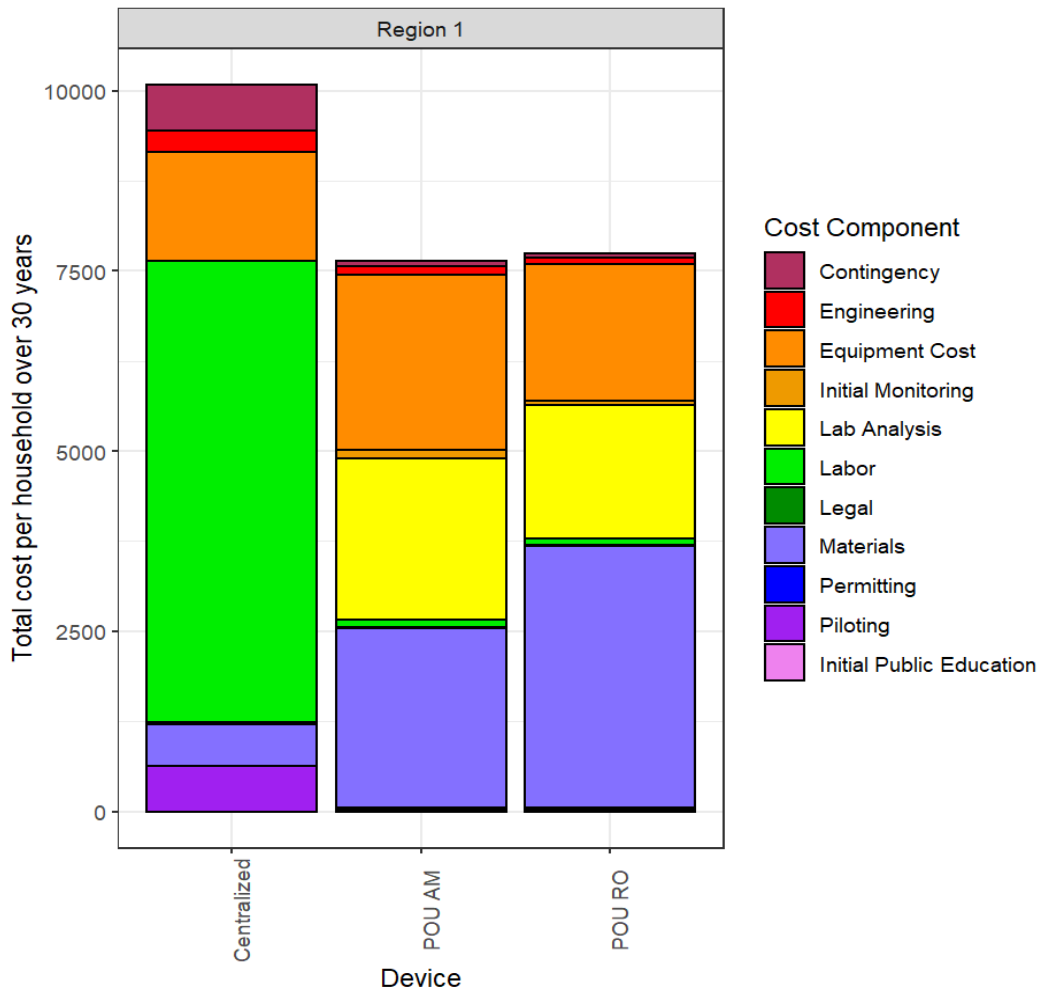

Figure 5.3: Total cost per household over 30 years for each alternative in Region 1 with a breakdown to show the cost elements.

5.2.2.2 Region 5 Cost Results

In Region 5, the total cost per household over 30 years is lowest for the centralized treatment improvement. The treatment improvement is small, therefore, the total direct cost per household over 30 years is \$36, the total indirect cost is \$35, and the total O&M cost is \$298, which consists primarily of labor for the operation of the treatment facility. The total direct cost for POE AM Device N was \$3,774 per household over 30 years, the total indirect cost was \$905, and the total O&M cost was \$16,467. The larger total O&M cost per household is driven by the equipment cost for the POE unit, the cost to replace the adsorptive media over time, and the cost of lab sampling for compliance in all 221 homes in the first year of operation. For POE AM Device K, the total direct cost is \$3,559, the total indirect cost is \$1,202, and the total O&M cost is \$10,496 per household over 30 years (Table 5.4).

Table 5.4: Summary of primary costs per household over 30 years in Region 5

Total cost (\$) per household over 30 years			
Improvement	Total Direct	Total Indirect	Total O&M
Central Upgrade	26	35	298
POE AM Device N	137	602	14,584
POE AM Device K	533	1,096	28,945

In Region 5, because there are many connections (221 homes), the cost to replace adsorptive media filter components in POEs and to conduct lab sampling for compliance is larger than in Region 1. In addition, the POE units are more expensive than the POU AM unit examined in Region 1; replacements are less frequent for the POE unit, but more expensive since the media needs full replacement which can be an intensive process. In addition, even as the portion of houses that must be monitoring yearly for SDWA compliance decreases, since the community consists of 221 homes, the total lab analysis cost is approximately \$10,000 for both POE devices per household over 30 years.

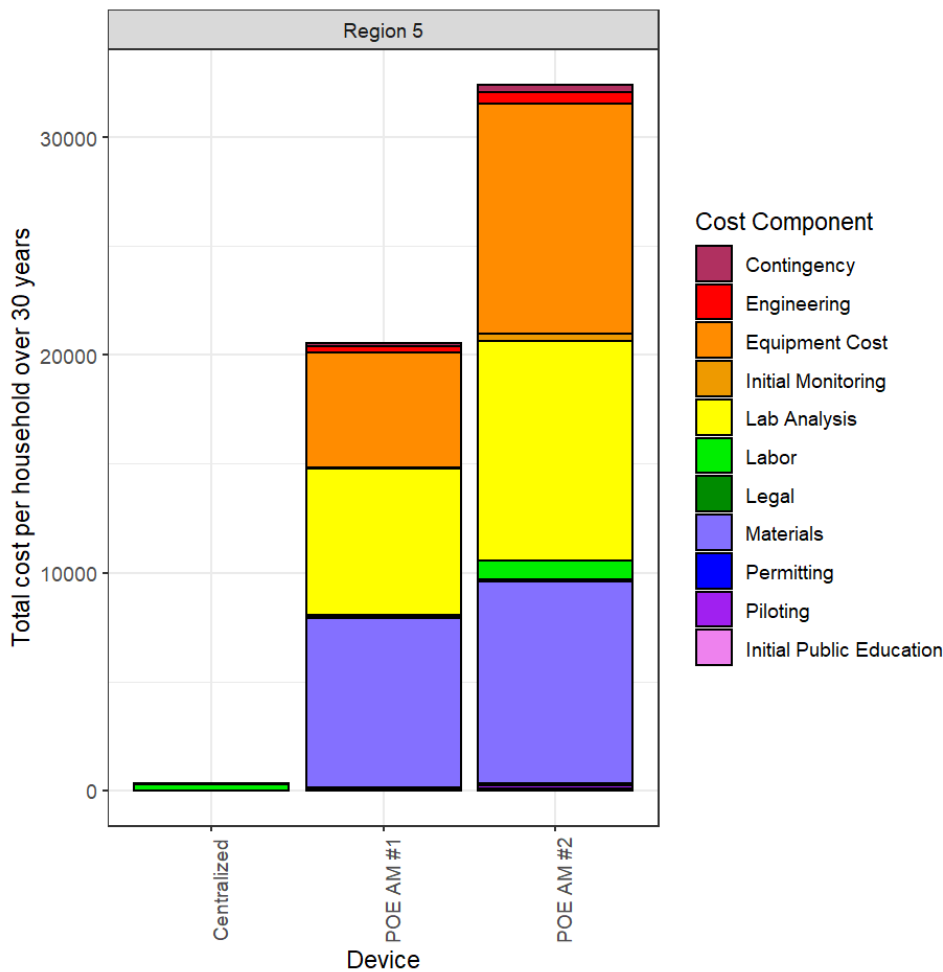

Figure 5.4: Total cost per household over 30 years for each alternative in Region 5 with a breakdown to show the cost elements.

5.2.2.3 Region 7 Cost Results

In Region 7, the centralized ion exchange treatment facility has the lowest per household cost over 30 years out of the three treatment options examined. POU RO Device D was the highest cost alternative, followed by POU RO Device G (Table 5.5) per household over 30 years. The centralized treatment option has a total direct cost per household over 30 years of \$914, a total indirect cost of \$296, and a total O&M cost of \$2,974. POU RO Device D has a total direct cost per household over 30 years of \$7,526, a total indirect cost of \$1,802, and a total O&M cost of \$13,498. POU RO Device G has a total direct cost per household over 30 years of \$5,626, a total indirect cost of \$1,346, and a total O&M cost of \$12,808, making it marginally cheaper than POU RO D. For both POU RO devices, the total O&M cost is higher than the centralized cost in part because 75 devices must be maintained across the community and because both RO devices require pre-filters and post-filters be replaced yearly and the RO membrane be replaced every 3-5 years.

Table 5.5: Summary of primary costs per household over 30 years in Region 7

Total cost (\$) per household over 30 years			
Improvement	Total Direct	Total Indirect	Total O&M
Central Upgrade	914	296	2,974
POU RO Device D	2,414	258	13,498
POU RO Device G	1,834	194	12,808

The higher total costs over 30 years per household associated with the POU RO devices are a result of the lab analysis, equipment, and materials costs associated with each device. Higher lab analysis costs are largely driven by monitoring requirements for nitrate, which cannot be reduced over time; samples must be taken yearly in each home for nitrate (USEPA, 2006) in all 75 households as a precautionary measure. Nitrate contamination is associated with methemoglobinemia which impacts infants predominantly, and therefore samples are required at all locations yearly. There is also a higher public education and labor cost for the POU RO devices than seen in Region 1 due to the increased requirements to provide public notification surrounding the impacts of nitrate (as opposed to arsenic).

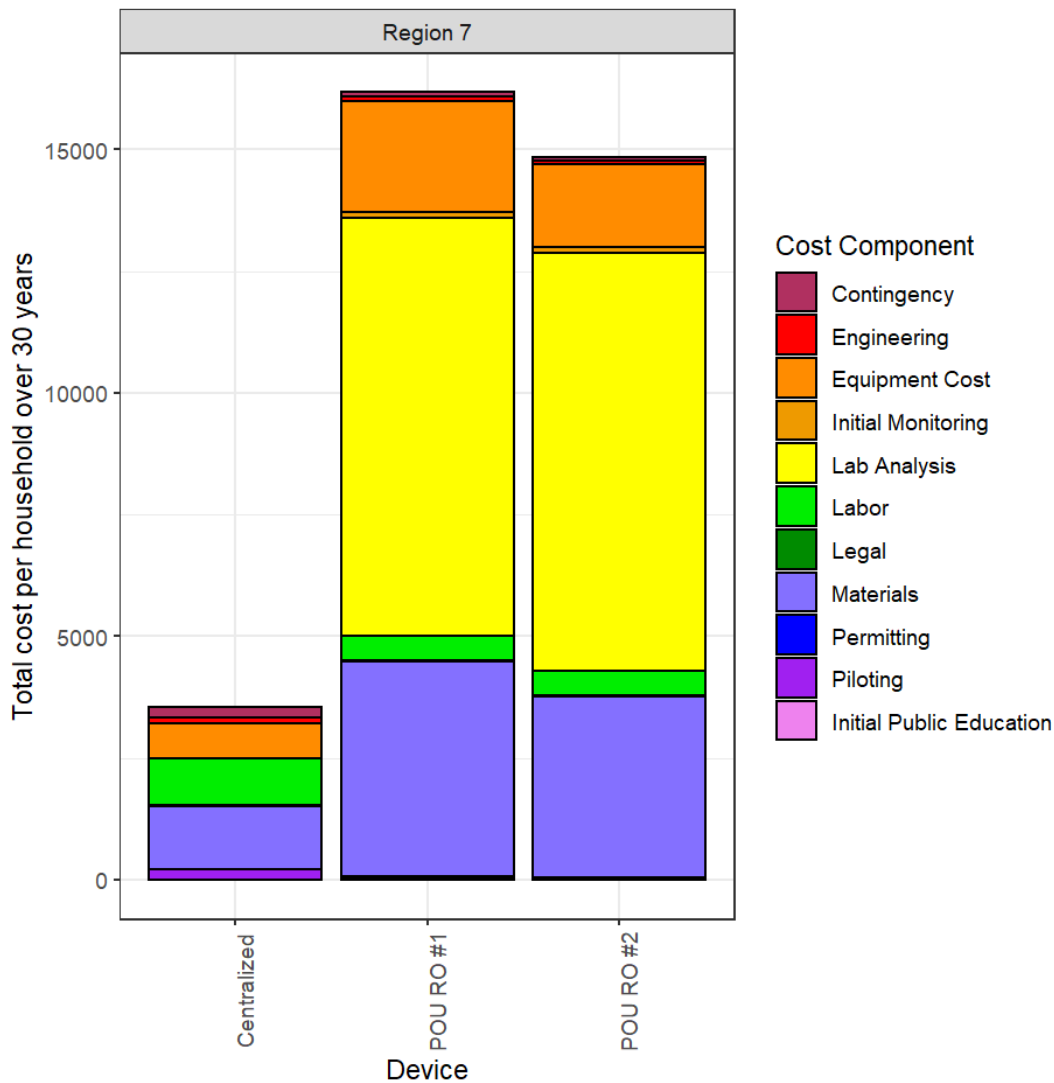

Figure 5.5: Total cost per household over 30 years for each alternative in Region 7 with a breakdown to show the cost elements.

5.2.2.4 Region 9 Cost Results

In Region 9, the centralized treatment improvement is the lowest cost alternative per household over the 30-year period. The centralized improvement has a total direct cost per household over 30 years of \$5,461, a total indirect cost of \$1,881, and a total O&M cost of \$7,307. Of the two POU devices selected for this CWS, POU AM Device B has a higher total direct and indirect cost per household over 30 years, but a lower O&M cost compared to POU RO Device D. The higher total O&M cost of the RO device is largely due to needing to replace multiple components over time, while the AM device has only one primary component to replace every 3-5 years.

Table 5.6: Summary of primary costs per household over 30 years in Region 9

Total cost (\$) per household over 30 years			
Improvement	Total Direct	Total Indirect	Total O&M
Central Upgrade	5,461	1,881	7,307
POU AM Device B	3,634	388	28,246
POU RO Device D	3,484	371	30,157

In Region 9, the labor cost associated with the POU devices results from a higher wage rate in California and an increase in the number of hours spent on POU maintenance compared to other regions. As observed with the other three regions, the lab analysis and equipment costs associated with the POU devices were a larger portion of the total cost per household over 30 years. For both the POU devices, the equipment cost is approximately \$10,000 per household over 30 years and the lab analysis is approximately \$20,000 per household. In Region 9, we assumed multiple samples were necessary in the initial year of monitoring and more samples were taken for compliance over time based on a report of a case study conducted in California (Corona Environmental Engineering, 2021). State sampling requirements for parameters such as nitrate and perchlorate match the recommendations from the Corona case study and other previous case studies conducted in systems using POU devices for arsenic and uranium contamination. Because there were several known case studies in California suggesting higher sampling frequency, we elected to use a higher initial monitoring requirement of 4 samples in the first year only as a result. Conversations with state administrators revealed that this is likely an overestimation of lab analysis costs over time as the frequency of sampling is expected to decrease if the POU devices are performing as intended.

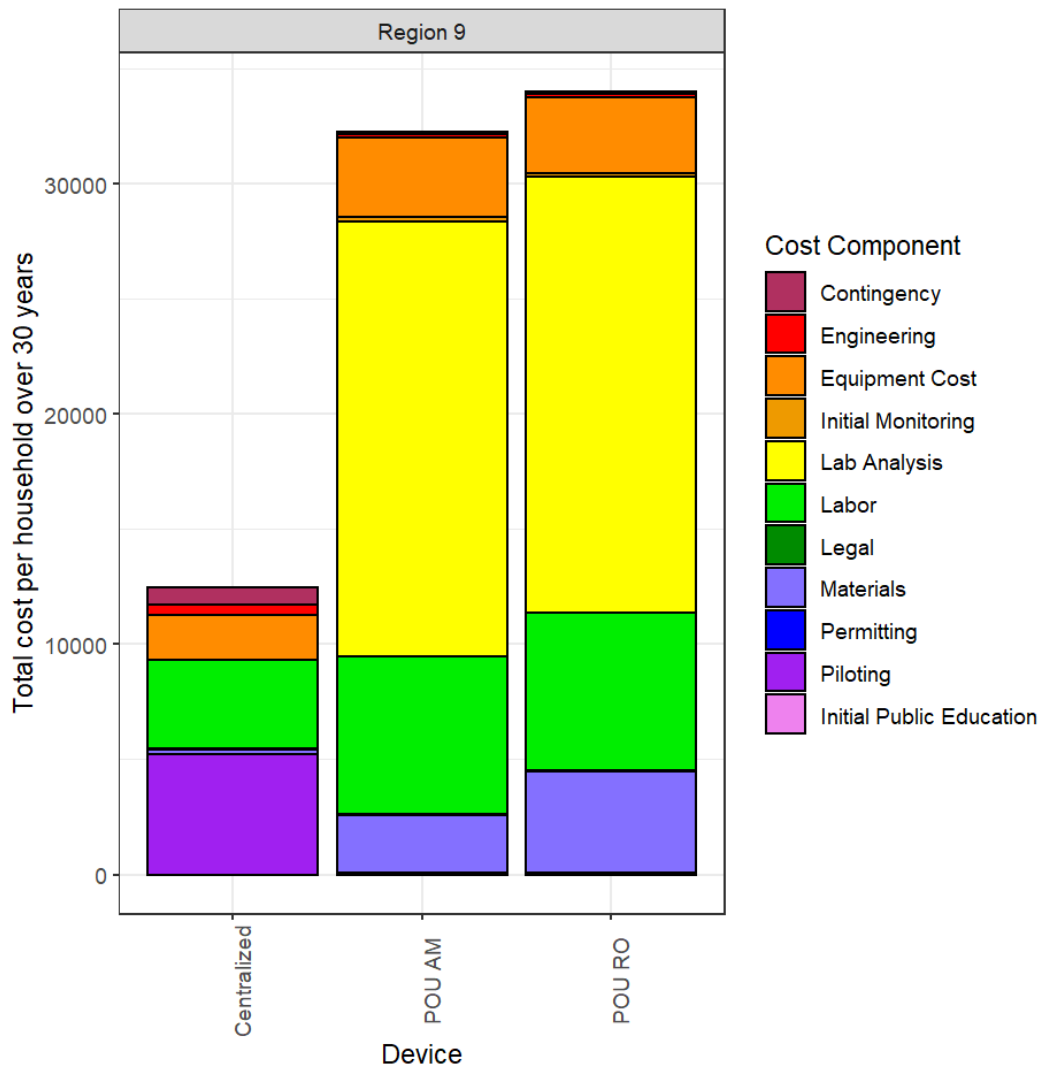

Figure 5.6: Total cost per household over 30 years for each alternative in Region 9 with a breakdown to show the cost elements.

5.2.3 Cost comparisons between centralized and POU/POE

When comparing the cost of POU/POE devices to centralized treatment costs using the EPA models, we made the following assumptions to align the cost element categories (Figure 5.5). The total cost is the total of the total direct, the total indirect and the total O&M costs over the 30-year period. Centralized treatment upgrade costs included the costs of fittings, valves, pumps, and instrumentation, aligning with the components included in the POU/POE equipment cost element. Centralized legal costs were calculated using the “Administration” line from the centralized cost models to align with the “Legal and Administrative” costs from the POU/POE models. Centralized material costs were calculated as the sum of media, resin and chemical costs, aligning with POU/POE materials costs. Finally, “Miscellaneous” cost for centralized treatment is the sum of miscellaneous costs for both equipment and O&M.

Table 5.7: Cost comparison (\$) by category of cost for each CWS over 30 years per household

Type of Cost	Region 1 (New Hampshire)			Region 5 (Illinois)			Region 7 (Nebraska)			Region 9 (California)		
	POU AM Device B	POU RO Device D	Centralized Upgrade	POE AM Device N	POE AM Device K	Centralized Upgrade	POU RO Device D	POU RO Device G	Centralized Upgrade	POU AM Device B	POU RO Device D	Centralized Upgrade
Total Direct	8,157	7,657	1,953	3,774	3,559	26	7,526	5,626	914	11,420	10,920	5,461
Total Indirect	1,942	1,822	761	905	1,202	35	1,802	1,346	296	2,736	2,616	1,881
Total O&M	4,817	6,728	8,880	16,467	10,496	298	13,498	12,808	2,974	28,246	30,157	7,307

Type of Cost	Region 1 (New Hampshire)			Region 5 (Illinois)			Region 7 (Nebraska)			Region 9 (California)		
	POU AM Device B	POU RO Device D	Centralized Upgrade	POE AM Device N	POE AM Device K	Centralized Upgrade	POU RO Device D	POU RO Device G	Centralized Upgrade	POU AM Device B	POU RO Device D	Centralized Upgrade
Equipment Cost	8,090	7,590	1,509	3,770	3535	26	7,510	5,610	716	11,400	10,900	1,949
Initial Public Education	9	9	NA	4	4	NA	16	16	NA	20	20	NA
Initial Monitoring	59	59	NA	0	19	NA	0	0	NA	0	0	NA
Permitting	243	228	11	113	106	NA	225	168	0	342	327	1
Piloting	243	228	626	113	106	NA	225	168	208	342	327	5,227
Legal and Administrative	243	228	30	113	106	NA	225	168	12	342	327	52
Engineering	404	379	299	189	530	NA	376	281	120	570	545	446
Contingency	809	759	637	377	353	NA	751	561	221	1,140	1,090	728
Labor	101	101	6,405	83	574	298	508	508	970	6,840	6,840	3,835
Materials	2,479	4,390	570	7,800	9286	0	4,398	3,708	1,305	2,479	4,390	209
Lab Analysis	2,236	2,236	NA	8,585	10113	NA	8,591	8,591	NA	18,927	18,927	NA
Residuals	NA	NA	268	NA	NA	NA	NA	NA	172	NA	NA	877

Total O&M costs made up the largest portion of the costs over 30 years for both centralized upgrades and POU/POE treatment options; however, these results can vary by system. In Region 1, the total O&M cost of the centralized upgrade is higher than either POU option per household over the 30-year timeframe, while the opposite is true for Regions 5, 7 and 9 where the total O&M cost of centralized upgrade is less than POU/POE alternatives. In addition, for all four systems, the total direct capital cost and the total indirect capital cost were higher for POU/POE devices than for centralized systems. One possible explanation for larger capital costs for POU/POE units is that their equipment costs are based on the number of homes in each community. In smaller communities such as in New Hampshire and California, the equipment cost per household is larger than in Nebraska and Illinois, where there are few houses to spread the capital cost of centralized treatment. Notably, in Region 5, the centralized treatment improvement is also a small improvement requiring only additional dosing equipment to improve pre-oxidation practices.

Figure 5.7 summarizes Table 5.7, showing the total cost over 30 years for each alternative by the cost component. The total cost to implement and maintain POU/POE systems is larger than the centralized treatment option. In New Hampshire, this is primarily because of material and equipment costs associated with frequently replacing POU/POE units. In California, lab analysis and labor costs drive the total costs of the POU/POE system. In Nebraska and Illinois (which have similar assumptions in Table 5.3), the larger cost of POU/POE devices is primarily driven by lab analysis and equipment and material costs.

Figure 5.7: shows the cost elements that constitute the total cost of each alternative in each water system.

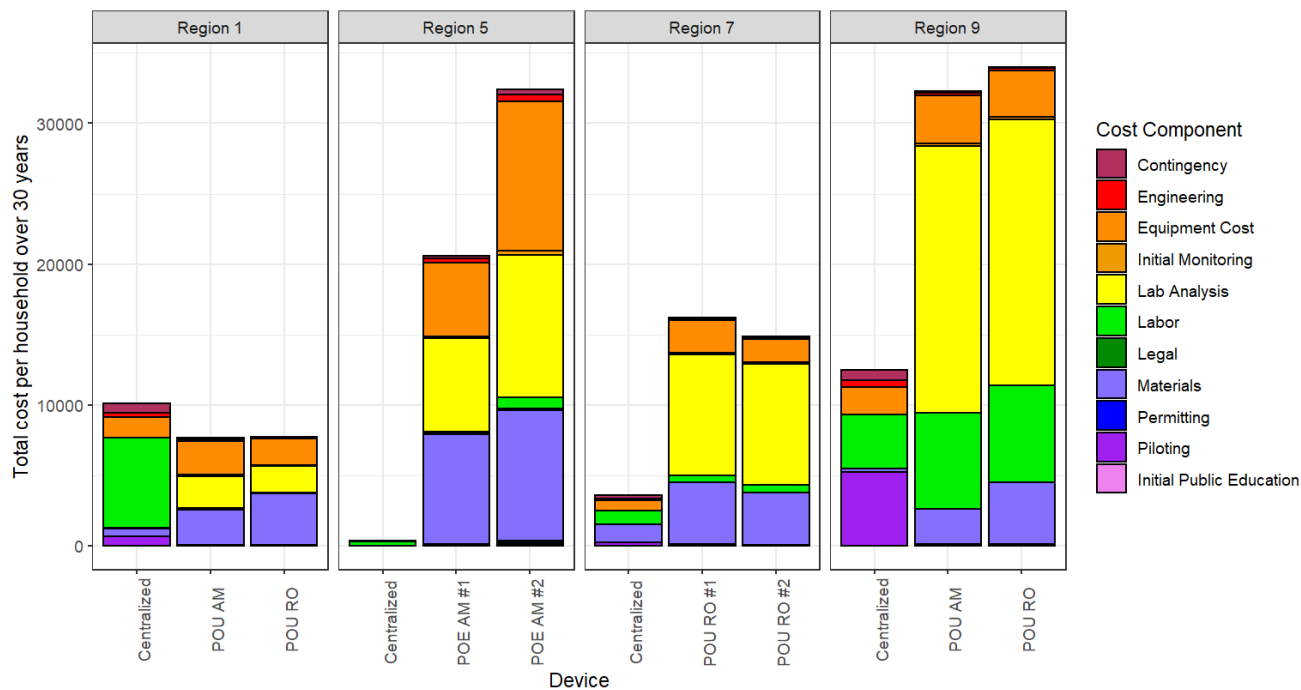

Figure 5.7: Total cost over 30 years for each alternative in each community water system.

Figure 5.8 presents the total cost over 30 years in the first year and in increments of 5 years to capture how cost increases over time for each alternative. In the first year of implementation, the total cost per household of a centralized upgrade is within the same order of magnitude as the installation of a POU/POE device. However, over time, the lab analysis costs, material costs and equipment costs of POU/POE devices increase at a faster rate than centralized treatment upgrades. Centralized treatment upgrade components only need to be replaced on average once in the thirty year time frame, or not at all. However, POU/POE components need to be replaced on average every five years, resulting in a higher equipment and materials cost compared to centralized upgrades. Region 1 and Region 9 have current systems serving approximately the same population and the POU devices considered in our analysis were the same. However, the labor and lab analysis cost model assumptions for Region 9 are such that the cost of ensuring SDWA compliance for the same devices as Region 1 are higher in Region 9, which results in the higher total cost per household over 30 years.

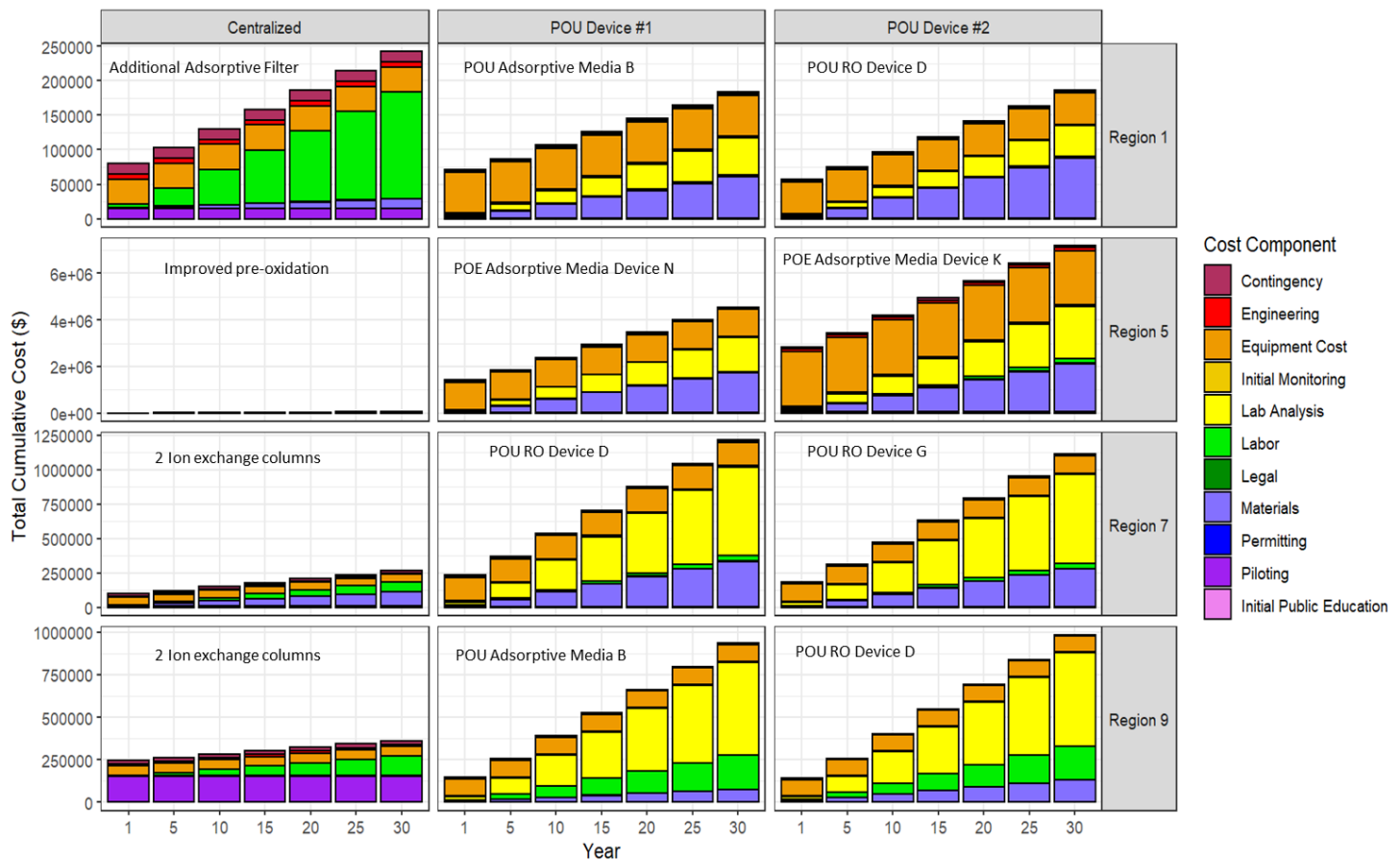

Figure 5.8: Summary of cumulative cost over time for each selected alternative to highlight differences in initial costs to a CWS compared to long term costs.

5.2.3 Cost Sensitivity Results

We conducted a cost sensitivity analysis for each technology option. For illustrative purposes, we present the individual analyses as well as a comparison figure to show the relative increase in cost in total dollars over 30 years for Region 1. For Regions 5, 7 and 9, only the comparison figure is shown in the text for Regions 5, 7 and 9, with full analyses in Appendix E. The cost sensitivity analysis focused on planning costs, the frequency of component replacements, labor costs, and specifically for POU/POE devices, the laboratory sampling costs. The y-axis of the following graphs shows an increase in a specific cost as a percent (either 25% or 50% increase). Because equations for cost are linear, an increase of 25% or 50% results in a change in total dollars of the same magnitude as a decrease by the same percentage. As a result, results are presented as an increase in cost; however, the cost savings for each scenario are the same if a decrease in cost where applied.

5.2.3.1 Region 1 cost sensitivity analysis results

In Region 1, centralized cost estimates were most susceptible to changes in labor costs. If the labor costs were increased by 50% (more hours worked), over 30 years, this can increase the total cost to the community water system by more than \$100,000 (Figure 5.8). In the centralized treatment option assumptions retrieved from the EPA Cost Models, the number of hours worked per year was used to analyze sensitivity while keeping the wage the same. Because centralized treatment requires more hours per year of maintenance and labor, the total cost increases when the time to complete operational and maintenance activities increases.

If the frequency of replacements is increased (decreasing the useful life of a component) by 50%, in Region 1 over 30-years, the total cost can increase by as much as \$60,000 for the community. A combination of increasing labor costs by 25% and replacement costs by 25% can increase the total cost by as much as \$75,000 for centralized treatment. The assumptions made about the time to complete maintenance (labor) and the frequency of replacement components can have a large impact on the total cost to a community over a 30-year period (Figure 5.8). In Region 1, replacing the centralized GFH adsorptive filter media every 7-10 years generated a total cost per household over 30 years less than the total cost for either POU. However, if the filter media needed to be replaced more frequently, requiring more labor, the total cost would increase to \$75,000 over 30 years, which is approximately \$3,125 additional for each home over 30 years.

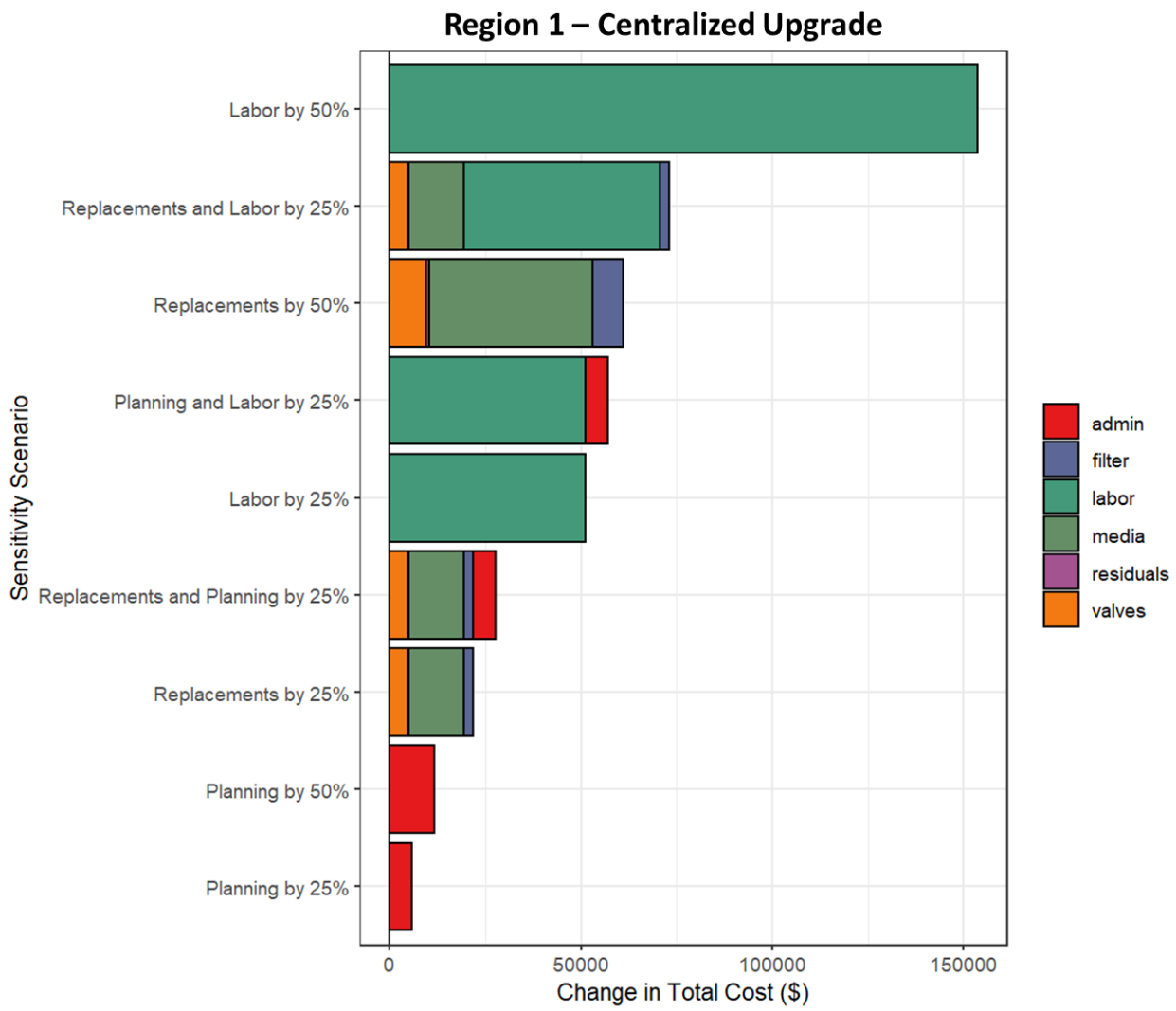

Figure 5.9: Cost sensitivity analysis results for centralized treatment in Region 1

In contrast, the cost sensitivity analysis results for the POU AM device and POU RO device show that for both POU devices, a change in the total planning costs (contingency, permitting, piloting, engineering and legal costs) generates the largest increase in the total cost over 30 years (Figures 5.10 and 5.11). For the POU AM device, an increase in the planning costs of 50% results in a total cost increase of approximately \$3,300, which equates to an additional cost per household of \$138 over 30 years. For the POU RO device, an increase in the planning costs of 50% results in a total cost increase of approximately \$3,100 dollars which equates to an additional \$129 per household over 30 years.

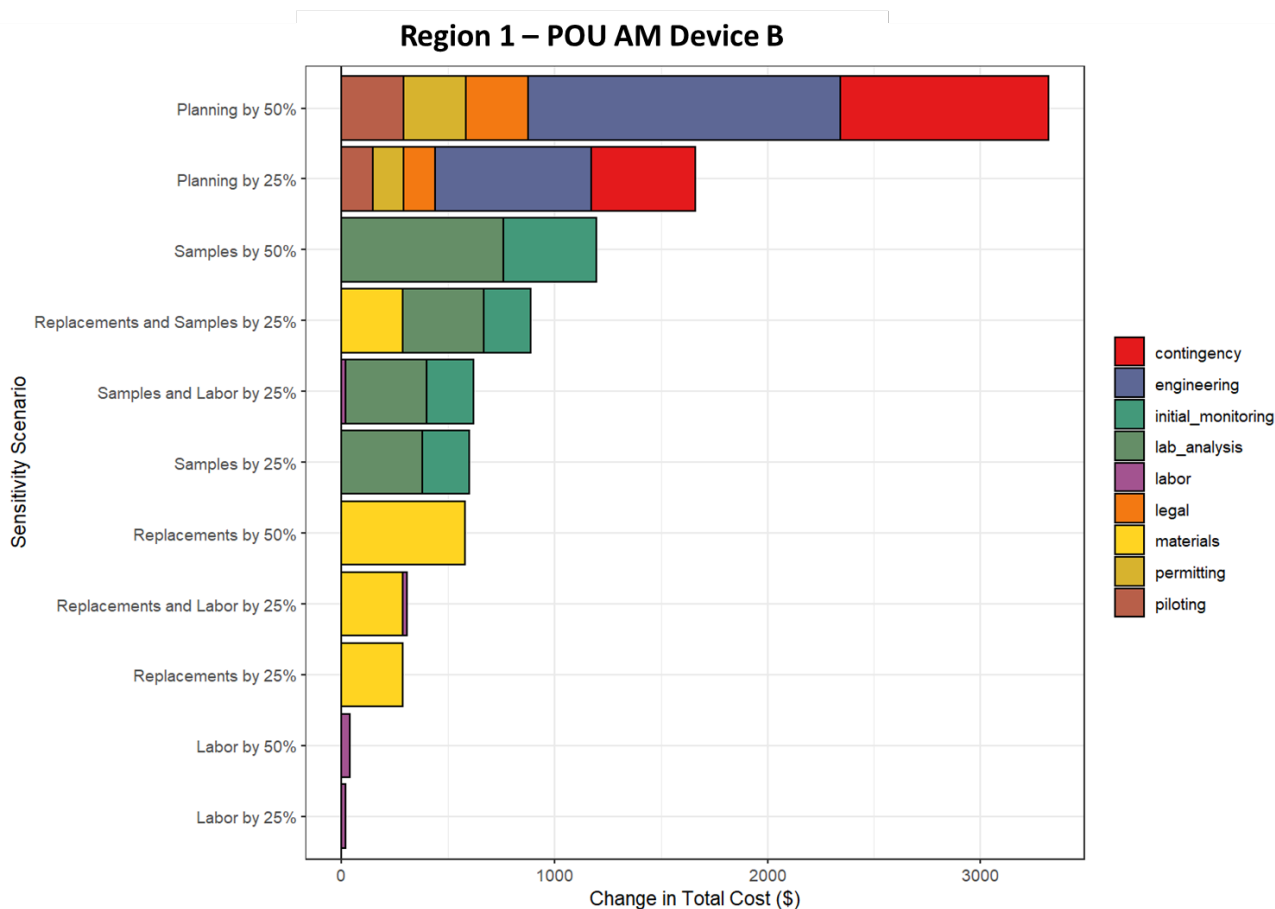

Figure 5.10: Cost sensitivity results for POU AM Device B in Region 1

For the POU AM device, an increase in the sampling cost by 50% results in an increase in the total cost of \$1,200 (or \$50 per household) over 30 years, largely driven by both lab analysis costs and additional initial monitoring costs. Similarly, an increase in the frequency of replacement by 50% results in an increase in the total cost of approximately \$600 (or \$25 per household) over 30 years (Figure 5.10). For the POU RO device, a 50% increase in the sampling cost increases the total cost by \$1,200 (or \$50 per household) over 30 years. A 50% increase in the replacement frequency results in an increase in the total cost of \$1,400 (or \$58 dollars per home) over 30 years (Figure 5.11). For the POU RO, the total cost is more sensitive to the change in replacement frequency because there are more components needing replacement. While the POU AM is designed to only need replacement of the adsorptive media component itself, the POU RO requires replacement of pre-filters, post-filters and the membrane itself. We hypothesize this is one reason the total cost for the RO device is more sensitive to an increase in the replacement frequency compared to the AM device.

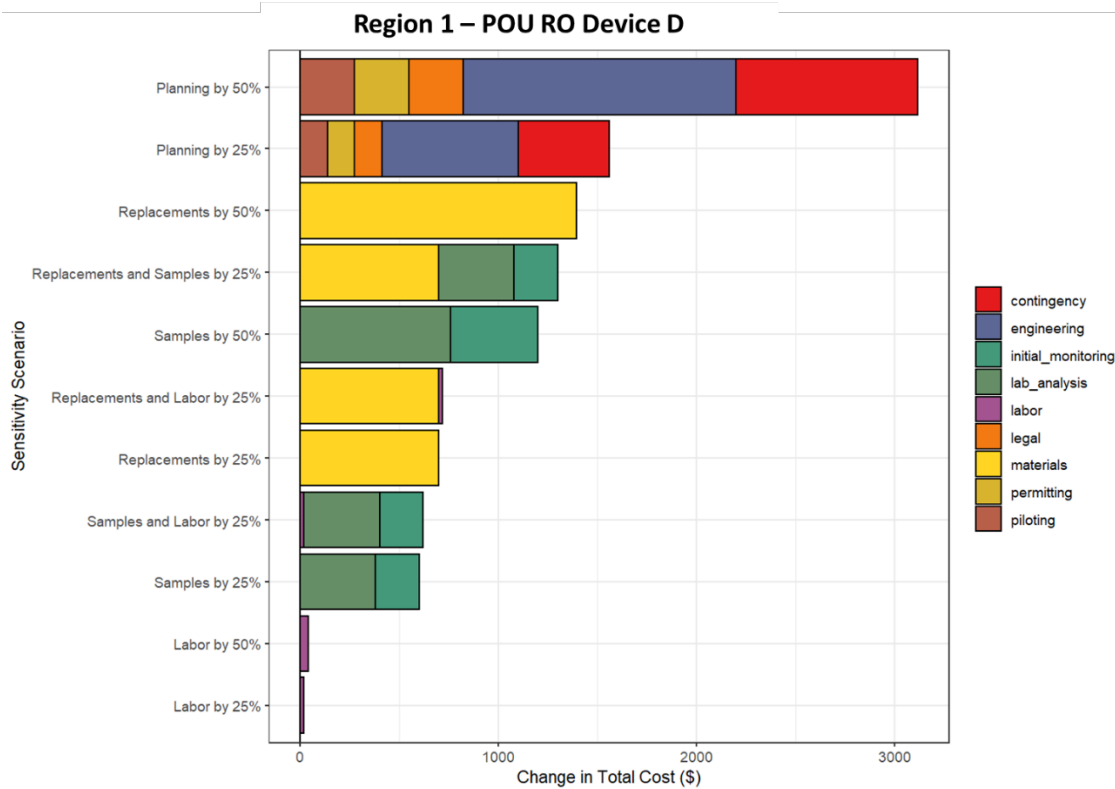

Figure 5.11: Cost sensitivity analysis for POU RO Device D in Region 1.

The increase in total cost in the centralized treatment is at least one order of magnitude greater than the increase in cost in the POU devices (Figure 5.12). POU device components are less expensive than centralized treatment components and, while these components need to be replaced at several locations, the cost is still an order of magnitude smaller than replacing components in the centralized system. In addition, the centralized treatment system cost is highly sensitive to changes in labor costs; POU devices do not experience this sensitivity due to the small number of hours allotted to O&M per year in our modeling assumptions (1-5 hours per year per home). The labor variable was changed by increasing the number of hours spent on operational activities. As a result, in the POU model, the number of hours spent on O&M increased to 1.5-7.5 hours with a 50% increase. Conversely, in the central systems, 127 hours of operator labor were allotted from the EPA Cost model; an increase of 50% resulted in 191 hours of labor at the same rate, causing the substantial increase in the total cost. Therefore, one possible advantage of POU devices may be the decrease in total labor costs over time compared to central treatment.

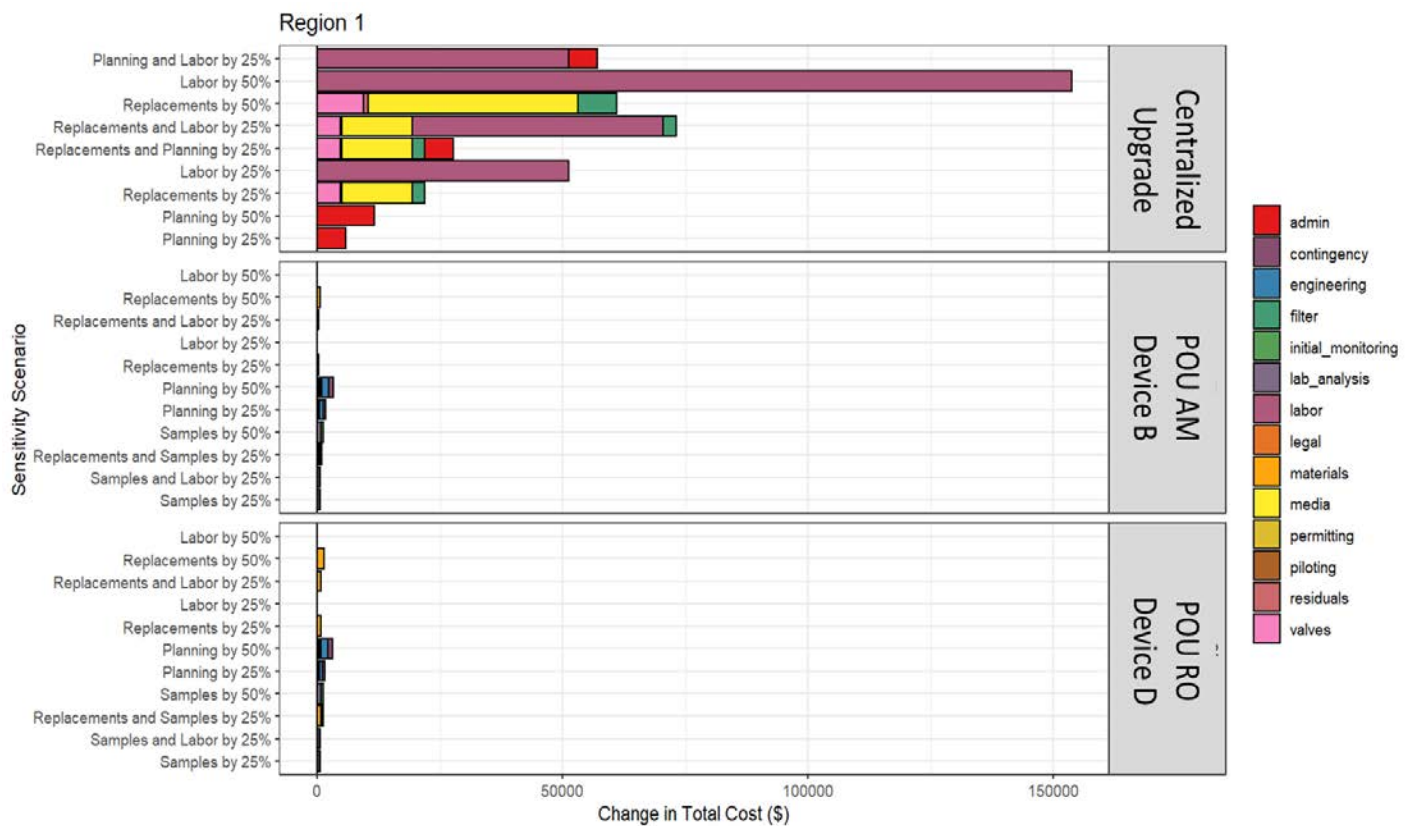

Figure 5.12: Full comparison of cost sensitivity analysis for Region 1.

5.2.3.2 Region 5 cost sensitivity analysis results

In Region 5, centralized treatment costs were most susceptible to changes in labor, similar to the findings in Region 1. In Region 5, centralized treatment costs consisted primarily of PVC piping and a cast iron pump; therefore, the total cost was not sensitive to increases in replacement frequency, as most of the components have a 17-year useful life. An increase in labor costs by 50% increases the total cost of centralized treatment by as much as \$2,000,000 over 30 years, corresponding to an additional \$9,050 per household. Even with this increase in per household cost, the total cost per household over 30 years of centralized treatment is still less than the total cost associated with either POE unit (a total cost of O&M \$9,348 for centralized compared to \$10,496-\$16,467 for the POE units).

In comparison, for both POE units, the total cost is most sensitive to changes in planning costs, partly because planning costs are a percentage of the total direct cost. For POE Device N, an increase in planning costs of 50% resulted in an increase in the total cost of approximately \$65,000 over 30 years (or \$294 per household), while this was \$140,000 for POE Device K. For both POE devices, the total cost was also sensitive to an increase in replacement cost but less so to changes in sampling cost and labor costs. For POE Device N, an increase in the replacement frequency and cost by 50% would result in an increase in the total cost of approximately \$30,000 over 30 years (or \$136 per household), while the

same increase for POE Device K, would result in an increase in the total cost of approximately \$35,000 over 30 years (or \$158 per household).

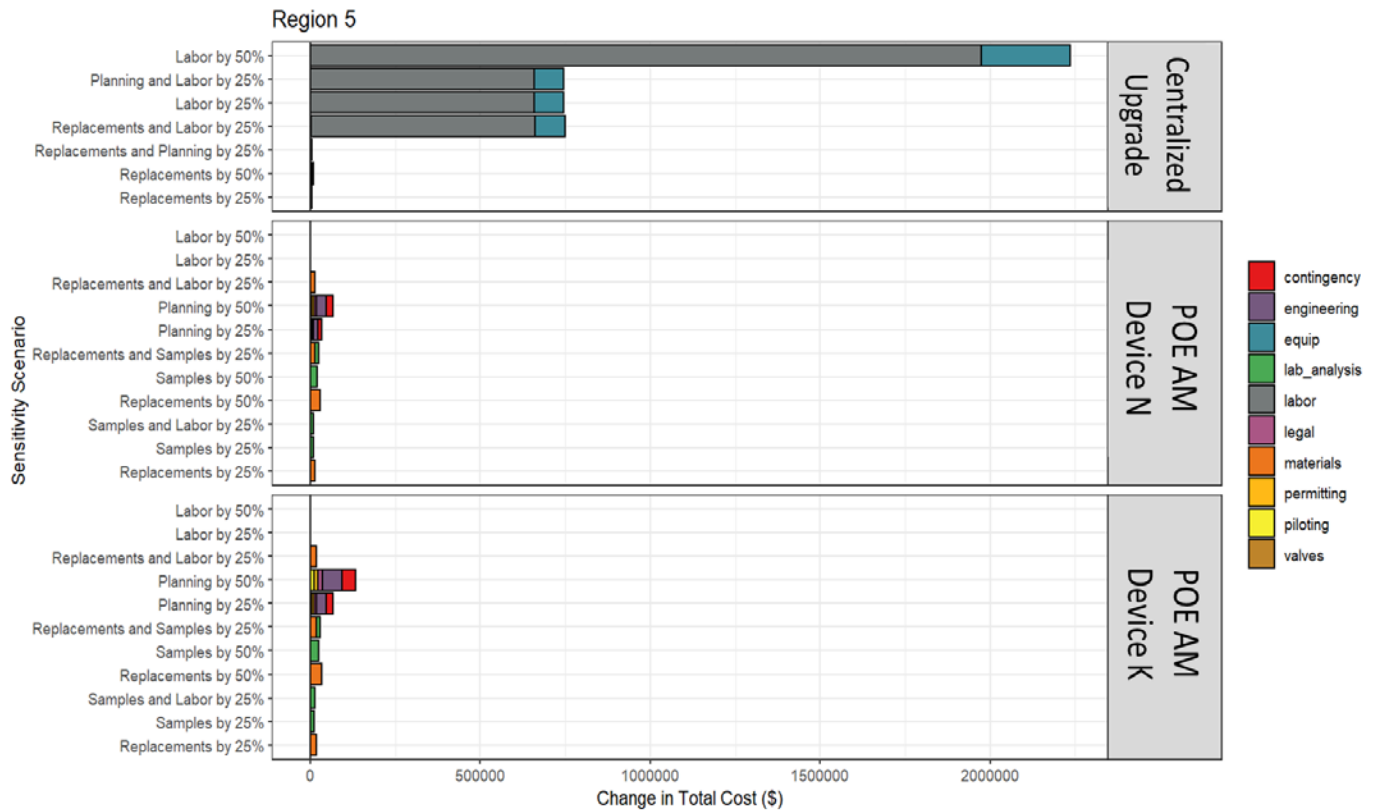

Figure 5.13: Summary of the cost sensitivity results from Region 5.

As in Region 1, the centralized improvement was most sensitive to increases in labor costs, resulting in an increase in the total cost two orders of magnitude greater than the increases in total cost for both POE devices (Figure 5.13). While the centralized improvement is most sensitive to changes in labor costs, the POEs were most sensitive to changes in both planning and replacement costs (see Appendix E for detailed cost sensitivity results).

5.2.3.3 Region 7 cost sensitivity analysis results

In Region 7, centralized costs were most sensitive to changes in the replacement of the ion exchange resin (Figure 5.13). Increasing the replacement frequency by 50% would increase the total cost over 30 years by approximately \$100,000 (or \$1,300 per household). An increase in the centralized system planning costs by 50% results in an increase in cost of approximately \$50,000 (or \$667 per household). Centralized system costs were least sensitive to changes in labor costs, which notably differs from Region 1 and 5. In Region 7, the centralized treatment system is a full new facility, whereas in Region 1 and 5, the improvement is a small addition to the existing system. As a result, in Region 7, we see the replacements of not only the ion exchange resin, but also from chlorination disinfection chemicals as well, has a larger impact on the total cost over time.

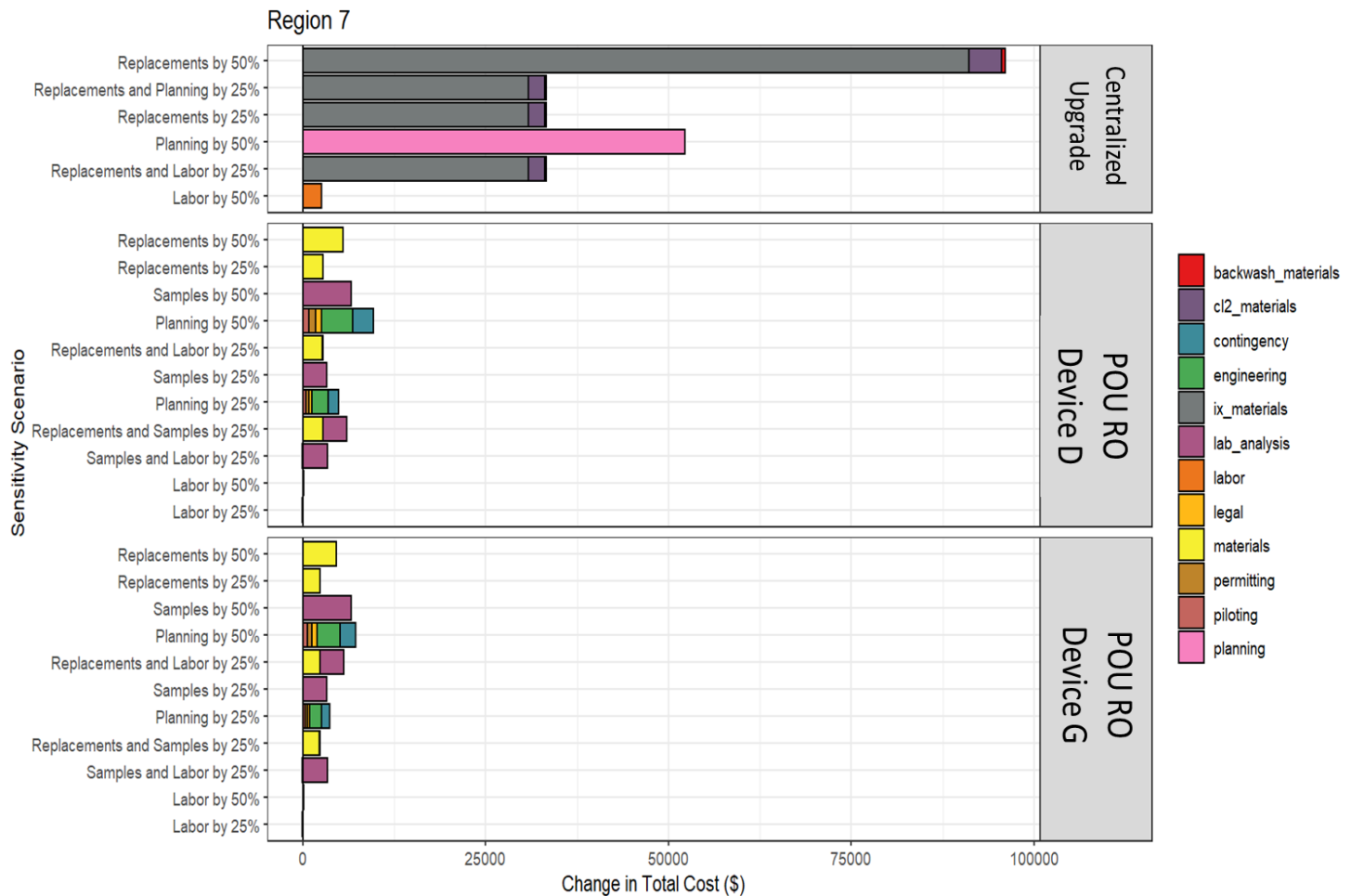

Figure 5.14: Summary of the cost sensitivity results from Region 7.

For both POU RO devices, each device is most sensitive to changes in the total planning costs, which are driven in part by the equipment cost. For POU RO Device D, a 50% increase in the total planning costs would result in an increase of approximately \$10,000 over 30 years (or \$133 per household), while for the same increase, for POU RO Device G, would be an additional \$7,000 over 30 years (or \$93 per household). Both RO devices are also susceptible to changes in sampling frequency as well. In Region 7, because the contaminant of concern is nitrate, the sampling frequency for compliance cannot be reduced over time since nitrate has acute health impacts on infants. As a result, an increase in sampling frequency of 25% would lead to an increase of approximately \$6,500 for both POU (\$87 per household). Neither RO device was sensitive to changes in labor costs. Increasing the frequency of replacements resulted in an increase of approximately \$5,500 for POU RO Device D (\$73 per household) and approximately \$4,500 for POU RO Device K (\$60 per household).

5.2.3.4 Region 9 cost sensitivity analysis results

In Region 9, centralized cost was most sensitive to the frequency of replacement (Figure 5.15). If replacement frequency were to experience a 50% increase, the centralized costs would increase by approximately \$170,000 (or \$5,862 per household). Similar to Region 7, the centralized treatment improvement is a new ion exchange facility, including an evaporative pond. Full replacement of the ion exchange media must occur more frequently than replacement of the adsorptive media in Region 1, and two vessels with resin are required in the basic ion exchange system (USEPA, 2017b). The centralized treatment improvement is also sensitive to changes in labor. An increase of 50% to the total hours of labor worked in Region 9 results in an increase of approximately \$120,000 (or \$4,138 per household).

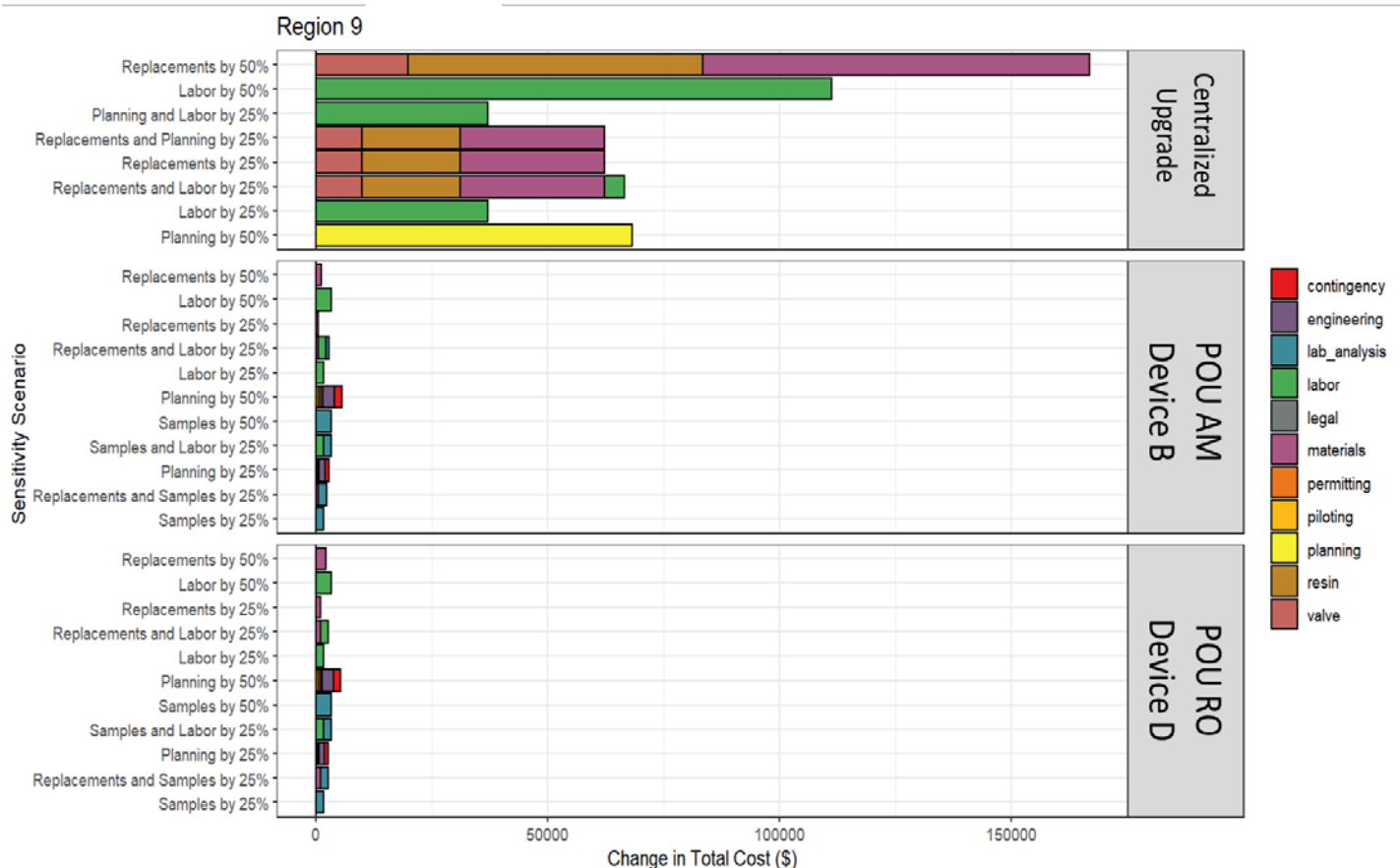

Figure 5.15: Summary of the cost sensitivity results from Region 9.

Both POU devices in Region 9 were most sensitive to changes in planning costs: an increase in the total planning costs for the POU AM or in the POU RO would increase costs by approximately \$5,500 over 30 years (or \$190 per household). Both devices are approximately equally sensitive to changes in sampling and labor; notably, in this region, both the number of hours spent on O&M activities and the labor age were the highest of all four regions, accounting in part for the greater sensitivity to changes in labor costs. A 50% increase in either the sampling costs or the sampling frequency yielded an increase in

total cost of approximately \$3,000 for either device (\$103 per household). The POU costs were more sensitive to costs related to POU operation and compliance than to the specific device, as the total cost was least sensitive to changes in the replacement cost over 30 years.

5.2.4 Best- and Worst-Case Cost Scenarios

The assumptions found through a literature search are presents in Table 5.8. Where values could not be found in literature, we selected the lowest value across the CWS assumptions found through stakeholder conversations to represent the best-case scenario. Similarly, we selected the highest value across all four case study CWSs for the worst-case scenario. Using this method, the best-case scenario may increase costs of some elements while decreasing costs of others compared to the specific CWS assumptions since values were derived primarily from literature. For example, sampling frequency after the first year may be reduced to a fraction of the total number of households in a community depending upon the state: we found that some states allow the community water system to reduce sampling frequency to a third of the total homes over time (best-case scenario). However, some states require the CWS to continue to sample 100% of the households after the first year (worst-case scenario), such as in New Hampshire. Therefore, when modeled with the best-case assumptions, the cost of sampling decreases, while the worst-case model in New Hampshire shows results similar to the model run with the NH assumptions, with the only increases resulting from increases in the wages paid to operators.

Table 5.8: Assumptions for best-case and worst-case cost modeling. Assumptions are primarily based on values found in past literature studies.

Sub-Section	Parameter	Units	Default Value in EPA Model	Best Case	Worst Case
Equipment Costs	Unit cost of POU/POE without installation	\$/unit	\$560.92	\$150	\$700
	Unit cost of UV system	\$/unit		\$0	
	Wage rate for installation specialist (plumber/electrician)	\$/hour	\$33.12	\$25	\$40
	Wage rate for system technical and maintenance labor	\$/hour	\$25.07	\$25	\$30
	Wage rate for scheduling and administrative labor	\$/hour	\$17.89	\$10	\$20
	POU/POE installation time	Hours/household	2	1	5
	POU/POE installation scheduling time	Hours/household	0.5	0.5	1
	UV installation time	Hours/household		0	
Technical Labor to Support Educational Program	Develop technical education materials	Total hours	10	0.5	10
	Develop nitrate health impact information	Total hours			

	Prepare for and attend public meetings	Total hours	2	1	2
	Post-meeting stakeholder communication	Total hours	2	0.5	2
Clerical Labor to Support Educational Program	Prepare educational materials for distribution	Total hours	6	0.5	6
	Prepare nitrate health impact information for distribution	Total hours			
	Prepare for and attend public meetings	Total hours	2	1	2
	Prepare post-meeting materials for distribution	Total hours	2	0.5	2
Communication for Materials for Educational Program	Print flyers announcing public meetings	Flyers	10	0	10
	Cost per flyer for printing	\$/flyer	\$2.00	0	\$2.00
	Buy ads to announce public meetings	Ads		0	
	Cost per meeting ad	\$/ad	\$40	0	\$40
	Print nitrate health impact flyers	Flyers		0	
	Print handouts for meetings	Pages/household	3/house	0	3/house
	Print inserts for billing mailers	Pages/household	1/house	0	1/house
	Cost to print handouts and mailers	\$/page	\$0.08	0	\$0.08
Initial Monitoring Costs	Time to take sample during first year	Hours/sample	0.25	0.25	0.5
	Time to schedule sample event at household	Hours/sample	0	0.25	3
	Number of samples per household during the first year	Samples/household	1	1	2
	Fraction of households sampled during the first year	% households	100	100%	100%
	Laboratory analysis fee	\$/sample	\$25.75 (arsenic) / \$24.25 (nitrate)	\$15	\$30
	Sample shipping cost (bulk)	\$/bulk shipment	\$9 for 15 samples	\$15	\$15
Indirect Capital Costs	Cost to obtain operating permit	\$/% of installed equipment cost	3	3%	3%
	Cost to conduct pilot study	\$/% of installed equipment cost	3	3%	5%
	Cost for legal activities	\$/% of installed equipment cost	3	3%	3%
	Cost for engineering activities (device selection)	\$/% of installed equipment cost	15	15%	15%
	Contingency cost (unknown factors)	\$/% of installed equipment cost	10	10%	10%

Equipment Maintenance Labor Costs	POU/POE maintenance	Hours/visit	0.5	0.25	2
	POU/POE replacement frequency	Visits/household/year	1	1	4
	*UV maintenance	Hours/visit	0	0	
	*UV maintenance frequency	Visits/household/year	0	0	
	Scheduling time	Hours/visit	0.5	0.25	0.75
Annual Monitoring Costs	Sampling time (including travel)	Hrs./sample		0.25	1.5
	Sampling scheduling time	Hrs./sample		0	0.25
	Analysis frequency (samples)	Samples/household/year		1	2
	Analysis frequency (Percent)	% households/year		33.3%	100%

Overall, for all of the POU/POE devices modeled, the total cost calculated with the best-case scenario assumptions was smaller than the total cost calculated with the CWS specific assumptions (Figure 5.16). Lab analysis shows the greatest decrease in cost over 30 years with the best-case scenario resulting from decreasing the fraction of houses sampled after year one. In Region 1, lab analysis cost would decrease by \$1,000 over 30 years (\$42 per household) compared to the New Hampshire cost model assumptions, while in Region 5, lab analysis costs would decrease by over \$50,000 (\$226 per household over 30 years).

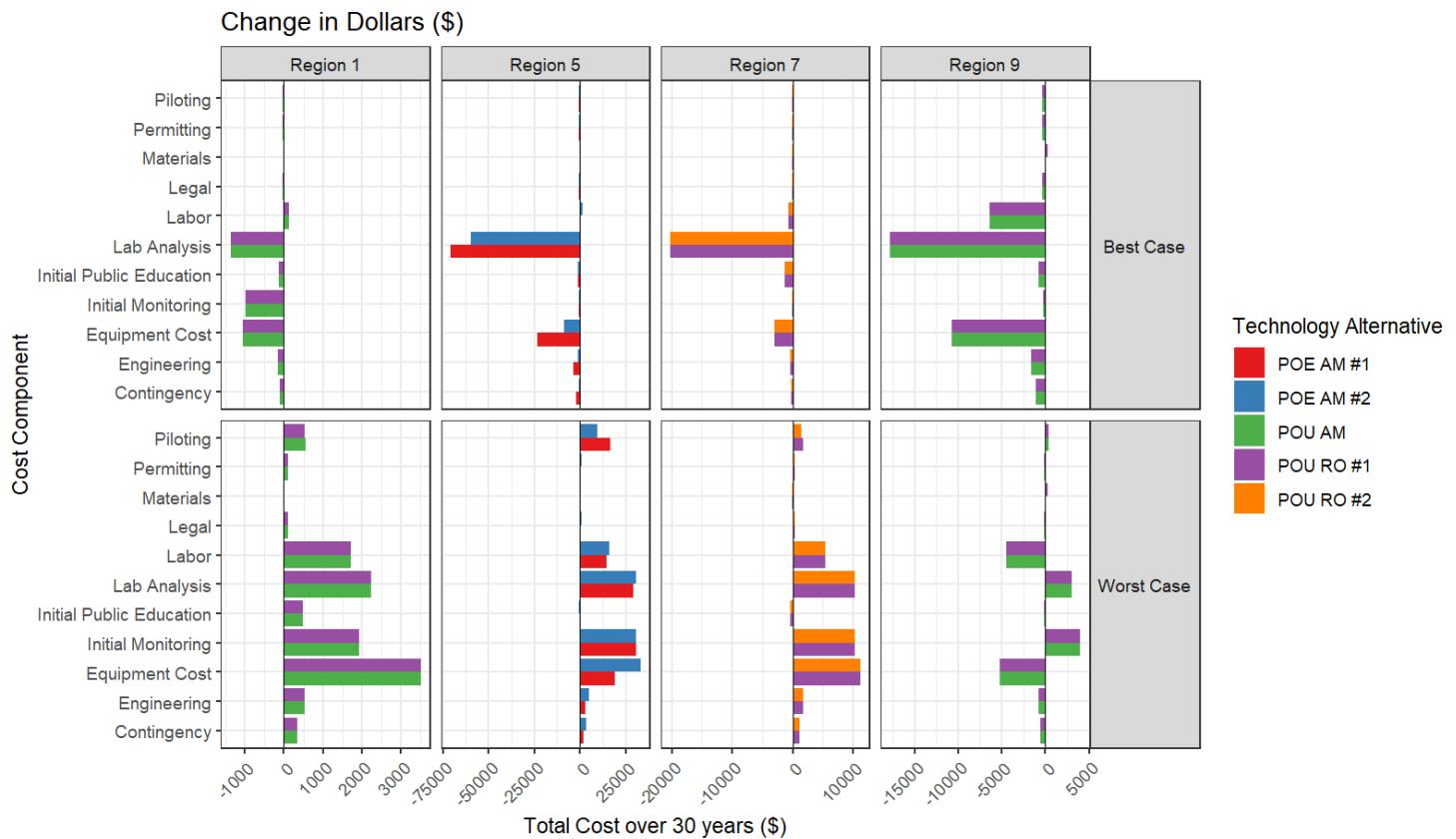

Figure 5.16: Summary of best-case and worst-case cost sensitivity results in all four CWSs. The x-axis represents the change in the total cost over 30 years: a positive number indicates an increase in total cost and a negative number indicates a decrease in total cost.

Modeling total cost with the worst-case assumptions generates notable differences between each CWS. In New Hampshire (Region 1), all of the cost components with the exception of materials would increase under the worst-case assumptions found in literature compared to the CWS-specific assumptions for New Hampshire. Materials costs do not increase or decrease because these are device specific, and the results presented in Figure 5.16 assume the devices and component costs are dependent on the manufacturer-specified cost for a specific device. The same increase in cost compared to the CWS specific assumptions occurs in Region 5 and 9, although the increase in cost varies and decreases for some cost components in Region 7. For example, the equipment cost increases based on the number of households: in Region 1, the total cost over 30 years increases by approximately \$3,500, in Region 5 by approximately \$25,000, in Region 7 by approximately \$10,000. In Region 9, the equipment cost decreases by approximately \$5,000 in the worst-case scenario because the worst-case scenario assumptions are smaller than in Region 9.

In addition to the best/worst-case analysis, we also specifically examined a longer useful life for the RO membrane component of POU Device D. Through conversations with additional device manufacturers, we learned that newer RO devices have a membrane that last up to 10 years compared to the 3–5-year

lifetime identified for the specific devices selected in this study. If the useful life of an RO membrane is increased to 10 years (3 full replacements over 30 years), then for POU Device D, the total materials cost decreases in Regions 1, 7 and 9 compared to the materials cost found with a useful life of 3 years. The materials costs decreased by \$392 (\$16 per household) in Region 1, by \$1,225 (\$16 per household) in Region 7, and by \$617 (\$21 per household) in Region 9 over 30 years.

5.2.5 Summary of cost analysis results

Table 5.8 summarizes the alternative technologies by categorizing the lowest cost per household over 30 years as the best option for a CWS (3 for the lowest cost option, 1 for the highest cost). In three of four CWSs, the total cost per household over 30 years is the lowest for the centralized treatment improvement. Of the POU RO units, in Regions 1 and 9, the RO unit has a higher cost over time than the adsorptive media units, driven in part by more components needing frequent replacement in all households in the community. In Region 5, POE Device K is more expensive, driven by a shorter useful life of the media and a higher equipment cost in comparison to POE Device K. In Region 7, POU RO device G is less expensive than POU RO Device D, most likely from a slightly lower equipment cost; the frequency of replacement components was the same for both devices.

Table 5.8: Summary of best cost options for each CWS.

Region	Technology	Total Cost per household over 30 years (\$)
		3 = Best Option, 2 = 2 nd Best Option, 1 = 3 rd Best Option
1	Centralized Upgrade	1
	POU AM Device B	3
	POU RO Device	2
5	Centralized Upgrade	3
	POEAM Device N	2
	POE AM Device K	1
7	Centralized Upgrade	3
	POU RO Device D	1
	POU RO Device G	2
9	Centralized Upgrade	3
	POU AM Device B	2
	POU RO Device D	1

6 – Triple Bottom Line Approach Summary

6.1 CWS and Device Selection

Four CWS were selected as case studies using data from both the SDWIS database and information from state-level stakeholders in each EPA region selected. In Region 1, we selected a CWS serving 50 people in New Hampshire currently using adsorptive media filtration to treat arsenic, with a mean arsenic concentration of 8.3 µg/L in groundwater. In Region 5, we selected a CWS serving 450 people in Illinois currently using aeration and pressure sand filtration to co-precipitate iron and arsenic with a mean arsenic concentration of 21.6 µg/L in a series of ground water wells. In Region 7 we selected a CWS serving 150 people in Nebraska, currently distributing water from a wellhead with a mean nitrate concentration of 9.3 mg/L in groundwater wells. Finally, in Region 9, we selected a CWS serving approximately 50 people in California, with an inactive adsorptive media filtration treatment facility and both arsenic and uranium contamination in two groundwater wells.

In Region 1, we chose two POU devices, one certified to NSF/ANSI 53 (adsorptive media) and one certified to NSF/ANSI 58 (reverse osmosis) for arsenic removal. We identified a potentially viable centralized treatment upgrade as installation of a second adsorptive media filter unit to treat the full flow from both groundwater well heads with a specific arsenic removal filter media. In Region 5, we chose two POE devices (since only POE devices may be used for long-term compliance in Illinois), one certified to NSF/ANSI 53 and one with a media designed to remove arsenic and certified to NSF/ANSI 61. For the centralized alternative, we elected to optimize pre-oxidation of arsenic from As (III) to As (V) using pre-chlorination prior to pressure sand filtration. In Region 7, we selected two devices certified to NSF/ANSI 58 (reverse osmosis) for nitrate-nitrite removal. We chose ion exchange with a nitrate selective resin as the centralized treatment improvement in Region 7. Finally, In Region 9, we selected the same two POU devices as in Region 1 for arsenic removal and, for the centralized treatment system improvement, we chose anion exchange with a strong base polyacrylic resin as the CWS improvement.

6.2 Triple Bottom Line Approach results

Table 6.1 presents the summary results for the triple bottom line approach for each of the three treatment options in each CWS. We scored each option from 1-3, with 3 as the ‘best’ for each analysis. For exposure assessment, the best score was given to the option that minimized lifetime exposure to a person within each community, measured as the decrease in average daily contaminant dose from the expected exposure with no intervention. For the LCA, the best score was given to the option with the smallest relative overall impact in comparison to the other options. For the LCC, the best score was given to the option with the lowest total per household cost over the 30-year study period. The scores were then added up to generate an aggregate score for each alternative considered for the CWS.

While an aggregate score was used to make a judgement about the “best” alternative for each CWS, each analysis should be considered separately to avoid obscuring important results. For example, while a centralized treatment improvement device may score highly for cost, the contaminant exposure a

CWS population is exposed to may be deemed unacceptable by a CWS and therefore, regardless of the sustainability or cost of the alternative, be unacceptable. Similarly, if the cost of an alternative is so high that a community cannot finance the treatment option, the alternative may be unacceptable even if the sustainability of the device is preferred and exposure is reduced to an acceptable level. In the following discussion of each CWS, we use this aggregate score as a starting point only to examine which alternative may be the best option for a CWS.

Table 6.1: Summary of the triple bottom line results for each CWS

Region	Technology	Metric			TOTAL
		Decrease in contaminant exposure (ug/kg/day)	LCA	Total Cost per household over 30 years (\$)	
		3 = Best Option, 2 = 2nd Best Option, 1 = 3rd Best Option			
1	Centralized Upgrade	1	1	1	3
	POU AM Device B	3	2	3	8
	POU RO Device D	2	3	2	7
5	Centralized Upgrade	1	3	3	7
	POE AM Device N	2	2	2	6
	POE AM Device K	3	1	1	5
7	Centralized Upgrade	3	1	3	7
	POU RO Device D	2	2	1	5
	POU RO Device G	1	3	2	6

9	Centralized Upgrade	1	1	3	5
	POU AM Device B	3	2	2	7
	POU RO Device D	2	3	1	6

6.2.1 Region 1

In Region 1, no treatment option scored highest across all analyses, but centralized treatment scored lowest across all analyses. The POU Device B (AM) provided the largest reduction in contaminant exposure over the 30-year period due to its high removal efficiency of 99%, however, it had a larger relative environmental impact than POU Device D (RO device) due to the disposal and processing of both the adsorptive media and the stainless-steel housing. While POU Device D was considered the most sustainable alternative, it was also the most costly, driven by the frequent replacement of RO membranes, pre-filters and post-filters. The POU AM Device B treatment option had the lowest per household cost over the 30-year period because of its low material and equipment costs compared to the RO device and an enabling environment in New Hampshire that optimizes the labor cost for maintenance of devices in a CWS. The centralized treatment improvement, was the least sustainable, resulting from the mass of adsorptive media necessary in the system. Because the LCA impact assessment is based on the amount (in kg) of material needed in each device, both of the POU devices would have a lower impact. The centralized treatment alternative is also the least effective at removing arsenic based on a literature removal efficiency of 80%, resulting in a decrease in exposure that is below the 30-year cumulative NOAEL value but does not meet the same reduction in exposure as the POU devices. Despite the cost benefits of the centralized treatment upgrade, the alternative is ranked lowest among the three alternatives. POU Device B (AM) provides the best removal of the contaminant and is a compromise between the two POU options in terms of sustainability and cost.

In Region 1, the smaller population in the community is one factor that makes it easier to justify the selection of a POU device over centralized treatment. There are only 24 households in this CWS, so the O&M costs for the POU devices is not much lower than for the centralized treatment upgrade, particularly because the centralized treatment improvement also contains an adsorptive media component which increases the cost along with the environmental impact. The lab analysis costs with POU also contributes to the overall costs of POU: as a reminder, in this state, 100% of the homes must be sampled for compliance in the first year and in subsequent years.

6.2.2 Region 5

In Region 5, the nature of the centralized improvement and the use of POE devices as opposed to POU devices drives the results (Table 6.1). Similar to Region 1 results, both POE devices have a higher removal efficiency for pentavalent arsenic than the centralized treatment upgrade. POE Device N has a

removal rate of 97%, leading to the largest reduction in contaminant exposure, resulting in the highest ranking. However, this device is the most expensive over the 30-year study period and has the largest environmental impact, resulting in the lowest ranking among the three alternatives. Both POE devices have a larger environmental impact than the centralized system because of the large amount of adsorptive media to frequently replace compared to the relatively small amount of piping and pumping components necessary for the centralized pre-oxidation system.

Of the three options, the centralized is both the lowest cost alternative and lowest environmental impact. The centralized improvement consisted primarily of PVC piping and cast-iron pumping components, both which have 15–25-year lifetimes and do not need frequent replacements within the 30-year period. The larger useful life of centralized components compared to POU/POE devices results in a lower overall O&M cost. In addition, the centralized improvement did not contain components that have a large environmental impact in any phase of the life cycle (materials, processing, etc.) compared to the adsorptive media found in the POE devices.

The large difference in cost and environmental impact between the centralized treatment system and the POE devices stems from community-specific characteristics. In Illinois, only POE devices are allowed for SDWA compliance, and few examples of successful POE installations were available for reference. POE units are generally more expensive than POU units, require more maintenance and more frequent component replacement. Also, the larger population size of the community (221 people) means the cost of supplying and maintaining POE units in Region 5 is much higher than altering the existing treatment system. In addition, the centralized treatment system already had capacity to remove arsenic; the primary concern was bringing the arsenic levels below the MCL consistently. Based on conversations with the operators and managers, no past speciation of arsenic had been completed so there was no data to determine whether the current treatment system was only removing As (V) and not As (III); we assumed that the centralized system in place pre-intervention was only effectively removing As (V) and therefore pre-oxidation was a logical improvement for the system.

6.2.3 Region 7

In Region 7, the centralized treatment improvement provided the largest decrease in nitrate exposure over 30 years, since the centralized ion exchange system had a literature value removal efficiency of 90% which was larger than the removal efficiency for either of the POU RO devices. Choosing an option that removes as much nitrate as possible is a benefit since it is well documented that nitrate can have deleterious health effects on infants. The centralized treatment improvement also had the lowest cost over the 30-year study period when compared to either POU RO Device. Despite the need to replace the ion exchange resin in the centralized improvement, the useful life of the resin column is estimated at 10 years, longer than any of the POU RO components identified for the two devices in this study. Furthermore, the ion exchange resin only has to be replaced at one location whereas the RO devices would need to be replaced in 75 households over time.

However, the centralized treatment upgrade had the worst environmental impact when the impacts were normalized amongst the three alternatives, resulting from the ion resin, including obtaining and

processing the material and disposing the material to a landfill. In comparison, POU RO Device G has the lowest environmental impact of the three alternatives, driven by fewer components to replace over time compared to POU RO Device D. Device G was also more affordable. In Region 7, the centralized treatment improvement therefore provided the lowest cost option and the largest reduction in contaminant exposure, with a tradeoff associated with the centralized improvement in its larger environmental impact compared to the POU RO devices.

6.2.4 Region 9

In Region 9, POU Device B (AM) removed 99% of the arsenic in the system, resulting in the largest contaminant exposure decrease. However, due to arsenic concentrations above 30 ug/L in the source water, the 99% removal efficiency is not removing as much arsenic in California as was seen in Region 1. Even with the highest removal efficiency from POU Device B (99%), the cumulative average daily dose of arsenic would exceed the cumulative 30-year NOAEL within the 30-year timeframe because of the implementation timeframe. As a result, none of the options considered adequately remove sufficient arsenic, although we assigned ranking for consistency. It is likely that an additional improvement to the system will need to be made to ensure that arsenic is removed from the drinking water.

While POU Device B provided the largest decrease in contaminant exposure compared to no intervention, it was ranked second in both environmental impact and cost. The centralized treatment cost over 30 years is smallest compared to either POU device, despite the addition of a new treatment facility and an evaporative pond onsite for brine disposal. While the initial capital cost of the centralized treatment facility is more than the POU devices, the total cost over time is less because the O&J costs of the POU devices are influenced by the replacement frequency of device components in multiple households over time. Therefore, in Region 9, the POU AM ranks the highest. While the centralized improvement is the least cost option over 30 years, it lacks the ability to adequately remove arsenic and decrease exposure as well as having a large environmental impact due to the ion exchange resin transportation and disposal. Compared to the POU RO device D, POU AM Device B has a higher contaminant removal efficiency but a higher environmental impact. While POU Device B is ranked highest among all three options, aggregating the results into a single metric obscure some of the nuances of each alternative. In Region 9, the decision between which alternative to select will depend on CWS finances and preferences. If the sampling cost could be reduced over time, this could reduce the POU device cost further and make either device more comparable to the cost of centralized treatment.

POU Device G has the smallest environmental impact of the three alternatives, followed by POU Device B. The centralized treatment improvement has the largest overall environmental impact due to the large amount of anionic resin that needs to be processed, transported, and disposed of. In addition, in Region 9, the community is geographically remote, located more than 100 km from the nearest landfill, resulting in a higher environmental impact associated with both disposal of the centralized system components and the transportation impacts of moving components from the centralized treatment facility to the landfill.

7 – Considerations and Recommendations for POU/POE devices as a SDWA compliance strategy

Through this study, we identified several important considerations and assumptions related to the use of POU/POE devices as a compliance strategy in small CWSs. These include system and policy barriers, which constitute challenges to POU/POE implementation found at a regulatory or state level, and technical barriers, which constitute challenges to the long-term health, environmental, and cost impacts of POU/POE devices. Finally, we discuss specific assumptions used in our model that are subject to change based on CWS characteristics. We present these categories below in detail, as well as recommendations for different stakeholder groups involved in the process (state administrators, CWS stakeholders, and device manufacturers).

7.1 Systemic and Policy-Level Barriers

Our case study revealed several systemic or policy-level barriers that influence the feasibility and advantages of implementing POU/POE devices as a compliance strategy. First, using POU/POE devices as a SDWA compliance strategy is governed by what types of devices are allowed for treating specific contaminants in each state. For example, in Illinois, only POE devices are allowed for long-term SDWA compliance and have only been applied previously for radionuclides in specific conditions; had had POU devices been an option as a compliance strategy, the total cost per household over 30 years would have likely been much smaller than our case study findings for the two POE devices. According to the USEPA guidance document on POU/POE devices, a survey of states by the Association of State Drinking Water Administrators showed that there are states where POU/POE devices are not allowed as a compliance strategy and other states where no guidance currently exists on POU/POE for compliance (USEPA, 2006b). Over the course of this study, we shifted our focus from Region 6 to Region 7 to select a case study community in part because we could not locate a state where POU/POE devices would be allowed as a compliance strategy.

Among the model assumptions we explored, we found that the frequency and number of samples necessary to ensure POU/POE performance for compliance can be a driving factor in the cost to implement POU/POE units long-term. While all states we worked with required sampling of 100% of the samples in the first year of POU/POE device operation per USEPA guidance (USEPA, 2006b), whether a state can reduce sampling requirements (and therefore lab analysis costs) is state- and contaminant-specific. A decrease in sampling frequency may be advantageous where POU/POE devices are performing to manufacturer specifications. However, water use in each home depends on the household water consumption patterns and decreasing the sampling frequency could obscure breakthrough of a contaminant in a specific location due to early failure of the device. As a result, state and CWS discretion and input is critical to determining if the additional cost of sampling outweighs the benefit of ensuring public health is protected.

Another potential barrier to POU/POE implementation is the time and energy required to ensure that all households have an equitable access to safe drinking water by ensuring 100% household

participation. The USEPA requirement of 100% CWS participation is critical to protecting consumers from contaminated water; one homeowner with a POU/POE device cannot receive water with lower concentrations of arsenic than a homeowner with no POU/POE device. However, from conversations with state administrators, it can take 2-10 years to come to a legal agreement across 100% of households in a CWS to implement POU/POE devices. In Illinois, the only past POE installation our state contacts knew of was in a small community where it took 7 years to organize the community prior to pilot testing. In New Hampshire, we conversed with a water systems where expensive legal agreements had to be put in place, including a clause in the homeowner's agreement to allow an operator to access POU/POE units inside of people's homes. In California, some communities have considered installing POU under-sink units on the outside of the homes for ease of maintenance but also to assuage homeowner concerns with having an operator inside their home when the homeowner is not present. While in many places, the majority community homeowners may be open to the idea of a POU/POE device, they have concerns about the logistics of maintaining the POU/POE device over time. As a result, we see a need to continue exploring options to ensure homeowners understand POU/POE device benefits and to streamline the community engagement component to gain 100% participation through a systematic approach that acknowledges community concerns while continuing to move the implementation timeline forward.

Part of the difficulty implementing POU/POE devices as a CWS stems from the challenge of finding certified POU/POE devices that can be sourced locally and have readily available replacement components, particularly for rural communities. Over the course of this study, we encountered the challenge both of narrowing down a list of over 150 POU RO devices and locating a second POE device certified to NSF 53. Certification can be costly to a company – including running water quality testing and maintaining certification – so we were only able to initially locate one POE device certified to NSF 53. We did find several POE devices with media certified to NSF 61 and individual manufacturer performance testing, but not a complete NSF/ANSI or WQA certification. As a result, we spent considerable time locating and verifying a second POE device that fit the certification criteria used in this study. A small CWS water system will also encounter these concerns when searching for devices and do not have the benefit of a guiding taskforce to help them locate devices. In addition, if a CWS wants to use a POU RO unit, the problem the CWS will face is narrowing down the list of potential devices to those that can be found at a reasonable price locally. Furthermore, when we examined the list of potential POU RO devices available for pentavalent arsenic removal, we found it difficult to translate the information present on WQA, NSF International, and IAPMO listings to a device on the manufacturer and distributor websites. While it was easy to locate device information for some products, other product websites listed device model numbers different than the NSF International or WQA website; if we found the product on the website, sometimes it was unavailable through the local distributor and had to be sourced from another distribution or a location across the country.

Furthermore, POU/POE devices are certified for removal of specific contaminants while CWSs are responsible for providing water with acceptably low concentrations of all contaminants regulated by the SDWA. A POU/POE device may be certified to remove more than one contaminant; however, using a POU/POE device for SDWA compliance typically focuses on one contaminant at a time. For example,

in Region 5, past MCL violations of the arsenic MCL necessitate a solution to specifically remove arsenic from the system. While the POE may in practice remove multiple contaminants, the context around its implementation and monitoring was focused only on removal of and compliance with the specific contaminant. Therefore, it cannot be used to replace centralized treatment because of the need to meet MCLs for other contaminants.; the designed compliance strategy is designed so centralized treatment and the POE device work in tandem to ensure SDWA compliance. In this case, centralized treatment is allowing the system to meet all other relevant SDWA water quality regulations and the POE device focuses specifically on arsenic. However, implementation of POU/POEs to meet multiple SDWA compliance objectives is an interesting, but unexplored, option.

7.2 Technical Barriers

Our case study results revealed the importance of the number of households served by a CWS when considering POU/POE implementations. In the two larger CWSs in Region 7 and Region 9, the centralized treatment option was favorable overall partly because replacing POU/POE components at multiple households over time generated a higher cost O&M than the centralized option. Because POU/POE components such as RO membranes, pre-filters, and post-filters, and POE adsorptive media every 3-10 years, there is a large cost associated with replacing components in every household over the 30-year study period. For example, in Region 5 we observed that the replacement of the adsorptive GFH media in either POE unit was a significant component of the overall per household cost because the media needed to be replaced every 7-10 years in 221 households. In contrast, in Region 1, the difference in total cost between the centralized improvement and the POU devices was approximately \$5,000-6,000 over 30 years, compared to a difference in total cost of \$21,000-24,000 in Region 5 between centralized and POE devices. Because Region 1 only has 24 households, the cost of replacement materials is smaller than in the other three regions, narrowing the total cost difference between the centralized option and the POU devices. While Region 9 has a similar number of homes to Region 1, the difference in cost is larger due to the larger labor and lab analysis costs. The disposal and replacement of multiple components in POU/POE units are therefore a key driver of the total O&M cost over time and impact CWSs differently. Making devices more durable by increasing the useful life and decreasing replacement cost is one potential solution to ensuring POU/POE device longevity and acceptability over time.

In addition to systemic concerns with POU/POE device piloting, there are technical barriers that can make piloting a lengthy and costly process, particularly for very small CWSs. Many of the small CWSs included in this study run a water treatment plant intermittently, with no continuous 24-hour water supply. Supply and operational hours of the treatment facility are governed by demand and storage availability. As a result, piloting POU/POE devices in each specific CWS with water use patterns is critical to understanding how POU/POE devices will function in the CWS. In addition, the water quality of each CWS varies. When consulting with POU/POE device manufacturers, we asked questions about CWS specific water quality to determine whether additional components would be necessary to ensure the POU/POE device functions according to performance claims. For example, for the POE AM Device N in Region 5, the manufacturer recommended an additional iron prefilter because the iron to arsenic

ratio is 55:1. Piloting is therefore necessary to ensure that the POU/POE devices are properly configured to both the water demand and water quality present in each CWS.

7.3 Model Assumptions specific to CWSs

During this study, we conversed with four different states that each take a different approach to adopting and implementing POU/POE devices for small CWS SDWA compliance. We presented the assumptions we made for each of our analyses for both POU/POE and centralized treatment improvements and summarize the critical parameters that vary across states for future use of the triple bottom line approach.

For centralized treatment, we focused on components above and beyond current CWS operation to emphasize how the improvement would impact the system. For the four states we worked with, only Region 7 required additional water quality sampling for the centralized improvement. Because arsenic and nitrate sampling are already required by the SDWA, the frequency and number of samples taken would not increase with the centralized improvement. However, in Region 7, the addition of a chlorine disinfection system necessitated additional chlorine residual sampling in the distribution system that the CWS would have to pay for if the improvement was implemented. We identified these additional sampling requirements by consulting state specific treatment guidelines and monitoring programs. Additional sampling requirements for centralized treatment will be state specific; we therefore recommend CWSs work with state administrators to identify additional sampling costs.

In addition, centralized disposal of liquid waste streams such as brine from an ion exchange system, may be subject to state specific guidelines. We worked with state administrators in California to identify possible waste disposal scenarios for brine in the Region 9 CWS. The Region 9 CWS had a series of septic tanks onsite which are not considered an appropriate waste treatment method for ion exchange brine in California. As a result, state administrators suggested we add the construction and maintenance of an evaporative pond to the system as an evaporative pond would be the solution the state would ask the system to install if the centralized ion exchange facility was implemented. In addition, we also learned that some states allow POU RO reject water to be disposed of in a septic system in small communities where others do not. Therefore, waste disposal solutions for both centralized and POU/POE should be carefully considered to ensure appropriateness and to ensure that all system components are included in the alternative prior to analysis.

For POU/POE devices specifically, we noted several state specific guidelines or requirements that influence both the LCA and LCC analyses. First, while most states require sampling in 100% of the households in the first year of POU/POE operation, some states allow a CWS to reduce the percent of homes sampled per year based on the contaminant. For nitrate, no decrease in sampling frequency is recommended because nitrate is an acute contaminant for infants, but for arsenic, states such as California and Illinois have programs to reduce the number of samples over time. The percent of households sampled over time is critical to the overall lab analysis cost, which we noted was a large component of POU/POE total costs over 30 years.

In addition, the labor component of O&M activities for POU/POE devices varied between states. Labor costs changed based on both the wage paid to an operator and the amount of time spent on O&M activities. In Region 1, less than one hour was allotted for maintenance activities, while in Region 9, up to 4 hours was spent on device maintenance. As a result, the O&M costs between these two regions was noticeably different even though the CWSs had a similar number of households served. Since labor assumptions are state specific, we recommend CWSs consult with state administrators to develop O&M plans to ensure labor and maintenance costs are not underestimated.

Finally, for both centralized and POU/POE alternatives, the source water quality and specific contaminant of concern are both critical to the selection of an appropriate device or technology. USEPA guidance on POU/POE devices provides a list of the best available technologies that are considered appropriate for specific contaminants (USEPA, 2006b). POU/POE devices are listed by contaminant on the NSF International and WQA websites and, while there are multiple devices, we noted that not every technology type (ion exchange, RO, etc.) is certified to NSF/ANSI standards for a specific contaminant. As a result, choosing the technology type for a POU/POE application largely depends on the types of devices currently certified to NSF/ANSI standards, especially because USEPA guidance requires devices to be certified if they are being used for SDWA compliance (USEPA, 2006b).

For centralized treatment improvement options, we analyzed past water quality data and discussed operational concerns with state administrators and CWS stakeholders to identify appropriate technologies to evaluate. For example, in Region 5, our decision to examine pre-oxidation was driven by the water chemistry in the system: the iron to arsenic ratio is 55:1 and the amount of iron present in the groundwater makes technologies such as pre-oxidation preferable to adsorptive media technologies due to concerns of preferential removal of iron. Similarly, in Region 7, we identified ion exchange as an appropriate technology to remove nitrate because there were few competing ions such as sulfates in the ground water source. Furthermore, specific contaminant chemistry is also important to technology selection. For example, arsenic has two forms in water, and different technologies preferentially remove As (V) over As (III). Identifying the relevant water quality parameters to make an informed decision is key to selecting appropriate technologies.

7.4 Recommendations

In this section, we present specific recommendations for the different stakeholders involved in POU/POE implementation for SDWA compliance. We then provide recommendations and considerations for the use of the triple bottom line approach by water systems.

7.4.1. For CWS managers and stakeholders

For CWS stakeholders including managers, operators and homeowners interested in implementing POU/POEs for compliance, we recommend:

- Initiating the community household consultation process early when considering POU/POE devices as a compliance strategy to ensure 100% participation in a timely manner. Provide structure and support when creating legal agreements to facilitate 100% participation.

- Understanding the CWS financing situation to best forecast upfront capital costs and examine long-term O&M costs of using POU/POE devices as a compliance strategy.
- Understanding changes in operator certification requirements, legal administrative costs, etc. that would occur when implementing a centralized or POU/POE device. Consider hiring an engineering firm to establish these costs prior to making a commitment to either a centralized improvement or a POU/POE device.
- Streamlining and coordinating maintenance and sampling activities to limit the burden on households during O&M activities.

7.4.2 For POU/POE device manufacturers and distributors

For POU/POE device manufacturers and distributors, we recommend:

- Aligning the information available to CWSs across the certifier, manufacturer, and distributors websites and media platforms to ensure that CWSs have easy access to device cost and performance information.
- Collaborating with state agencies and administrators to pilot and test device performance with CWS specific water quality to decrease the time required to pilot and implement POU/POE devices.
- Increasing the durability and useful life of POU/POE components to decrease the frequency of replacing components to ultimately decrease the total overall O&M costs of POU/POE devices over the long-term.
- Include clear information on manufacturer or trade association websites that can be used not only by homeowners, but also by CWS managers to understand the appropriateness of POU/POE devices as a CWS SDWA compliance solution.

7.4.3 For State administrators

For state administrators and agencies, we recommend:

- Establishing clear guidance for both POU and POE devices within the state to allow small CWSs greater flexibility to meet SDWA compliance regulations.
- Continually review the sampling requirements for POU/POE device compliance over time to verify whether the sampling program is both cost effective for the community and whether the POU/POE device is adequately removing the contaminant of concern at a representative number of households within the CWS.
- Helping CWS stakeholders to adequately characterize the water quality in both the source and treated water to enable informed decisions about appropriate technologies. For example, speciating arsenic to understand whether additional pre-oxidation is needed for the removal of As(III) in addition to As (V).
- Establishing clear procedures to permit and approve POU/POE devices to minimize a case-by-case approach. The state should document the steps taken to approve the POU/POE solution to aid future CWSs interested in using POU/POE devices as a solution and promote knowledge sharing.
- Providing support and structure for constructing legal agreements in CWSs that facilitate 100% household participation in a timely manner.

7.4.4 Future use of the triple bottom line approach

To obtain accurate results from the triple bottom line approach, we have compiled the following recommendations for CWSs or state administrators looking to leverage this approach for very small water systems.

Exposure Assessment

1. Exposure assessment calculations should account for lifetime exposure to ensure that exposure over time is not an underestimation. We recommend evaluating exposure to an infant, child and adult over the study period to examine a worst-case exposure scenario using the average daily dose equations.
2. Exposure routes should be specific to the contaminant being evaluated. While this study examined contaminants where inhalation and dermal exposure was negligible, the inhalation and dermal exposure routes should be accounted for when examining volatile inorganic contaminants and other contaminants with inhalation and dermal information available from the EPA IRIS database.
3. In general, additional studies are needed to model inhalation of aerosolized water particles, including the concentration of a contaminant that is aerosolized and the lung absorption rates of different individuals to understand if inhalation risk is truly negligible from water.

Life Cycle Assessment

1. Disposal of waste media and materials from both centralized and POU/POE devices needs to be examined to determine if the concentration of contaminants in device components are non-hazardous or hazardous waste. For the purposes of this study, we assumed the concentration of arsenic in disposed media would not be large enough to constitute a hazardous waste; however, for other contaminants this may not be the case. CWSs and state administrators need to work with device manufacturers to understand how much of a contaminant is present in spent media prior to landfill disposal.
2. A CWS may consider recycling or media regeneration as potential waste scenarios within the life cycle analysis. In this study, we assumed that materials would be disposed in a landfill; however, specific adsorptive medias can be regenerated or recycled, providing a more environmentally sustainable alternative.

Life Cycle Costing

1. Cost modeling needs to include the useful life and replacement frequency of all components of either a centralized improvement or a POU/POE device to capture the total cost over time of operating and maintaining the improvement. Other studies (Bixler et.al., 2021) have examined net present value or worth using an average useful life and a functional unit based on volume of water treated which may not accurately account for the total cost over time to a community.
2. State and CWS-specific cost assumptions need to be clearly documented and reported so that future studies can accurately compare results and make informed decisions. When reviewing literature to conduct this study, we identified several different cost models and assumptions that needed careful evaluation to determine their applicability to our study. We recommend states and CWSs keep a very clear record of the assumptions used to model cost.

References

- Allaire, M., Wu, H., Lall, U., 2018. National trends in drinking water quality violations. Proceedings of the National Academy of Sciences 115, 2078–2083. <https://doi.org/10.1073/pnas.1719805115>
- AWWA Research Foundation (AWWARF). (2005). POU/POE Implementation Feasibility Study for Arsenic Treatment. Retrieved from: <https://www.waterrf.org/research/projects/poupoe-implementation-feasibility-study-arsenic-treatment>
- Azuma, K., Uchiyama, I., & Okumura, J. (2013). Assessing the risk of Legionnaires' disease: The inhalation exposure model and the estimated risk in residential bathrooms. *Regulatory Toxicology and Pharmacology*, 65(1), 1–6. <https://doi.org/10.1016/j.yrtph.2012.11.003>
- Bilec, M., Ries, R., Matthews, H.S., Sharrard, A.L., 2006. Example of a Hybrid Life-Cycle Assessment of Construction Processes. *J. Infrastruct. Syst.* 12, 207–215. [https://doi.org/10.1061/\(ASCE\)1076-0342\(2006\)12:4\(207\)](https://doi.org/10.1061/(ASCE)1076-0342(2006)12:4(207))
- Bixler, T.S., Song, C. and Mo, W. (2021). Comparing centralized and point-of-use treatments of per- and polyfluoroalkyl substance. *AWWA Water Science*. DOI: 10.1002/aws2.1265
- Boffetta, P., Zunarelli, C., & Borron, C. (2020). Dose-Response Analysis of Exposure to Arsenic in Drinking Water and Risk of Skin Lesions: A Systematic Review of the Literature. *Dose-Response*, 18(4), 155932582095782. <https://doi.org/10.1177/1559325820957823>
- California Water Boards. (2020). Draft White Paper Discussion on: Long Term Solutions Cost Methodology for Public Water Systems and Domestic Wells. Retrieved from: https://www.waterboards.ca.gov/safer/docs/draft_whitepaper_lt_solutions_cost_meth_pws_dom_wells_updated.pdf
- Corona Environmental Engineering. (2021). Developing Equitable and Effective Early Action Plans: The Cost of Interim Drinking Water Solutions and Public Outreach for Nitrate Contaminated Drinking Water. Retrieved from: <https://www.communitywatercenter.org/coronareport>
- Davis, M. J., Janke, R., & Taxon, T. N. (2016). Assessing Inhalation Exposures Associated with Contamination Events in Water Distribution Systems. *PLOS ONE*, 11(12), e0168051. <https://doi.org/10.1371/journal.pone.0168051>
- International Association of Plumbing and Mechanical Officials [IAPMO]. (2021). Product Listing Directory. Retrieved from: <https://pld.iapmo.org/>. [3 February 2021]
- International Standards Organization [ISO] (2006). ISO 14040: Environmental Management – Life cycle assessment – principles and framework. Retrieved from: <https://www.iso.org/standard/37456.html>

National Sanitation Foundation [NSF]. (2021a). NSF Product and Service Listing: NSF/ANSI 53. Drinking Water Treatment Units – Health Effects. Retrieved from: <https://info.nsf.org/Certified/DWTU/Listings.asp?ProductFunction=053%7CArsenic+%28Pentavalent%29%3C%3D50+ppb+Reduction&ProductType=&submit2=Searchhttps://info.nsf.org/Certified/DWTU/Listings.asp?ProductFunction=053%7CArsenic+%28Pentavalent%29%3C%3D50+ppb+Reduction&ProductType=&submit2=Search> [15 March 2021].

National Sanitation Foundation [NSF]. (2021b). NSF Product and Service Listing: NSF/ANSI 58. Reverse Osmosis Drinking Water Treatment Units. Retrieved from: <https://info.nsf.org/Certified/DWTU/Listings.asp?ProductFunction=058%7CArsenic+%28Pentavalent%29%3C%3D300+ppb+Reduction&ProductType=&submit2=Search> [15 March 2021].

National Sanitation Foundation [NSF]. (2021c). Search for NSF Certified Drinking Water System Components. Retrieved from: <http://info.nsf.org/certified/pwscomponents/index.asp?standard=061>

Oxenford, J. L., & Barrett, J. M. (2016). Understanding Small Water System Violations and Deficiencies. *Journal - American Water Works Association*, 108, 31–37. <https://doi.org/10.5942/jawwa.2016.108.0040>

Powers, M., Yracheta, J., Harvey, D., O’Leary, M., Best, L. G., Bear, A.B., MacDonald, L., Hasan, J. S. K., Thomas, E., Morgan, C., Olmedo, P., Chen, R., Rule, A., Schwab, K., Navas-Acien, A., George, C.M. (2019). Arsenic in groundwater in private wells in rural North Dakota and South Dakota: Water quality assessment for an intervention trial. *Environmental Research*. Vol. 168. Pp. 41-47. Doi: <https://doi.org/10.1016/j.envres.2018.09.016>.

Rubin, S.J., 2013. Evaluating violations of drinking water regulations. *Journal - American Water Works Association* 105, E137–E147. <https://doi.org/10.5942/jawwa.2013.105.0024>

Speth, T., R. Khera, C. Patterson, AND P. Ransom. Cost of POU vs Centralized Treatment. 2020 WQA Virtual Annual, NA Virtual Meeting, OH, April 16 - 21, 2020. Retrieved from: https://cfpub.epa.gov/si/si_public_record_report.cfm?Lab=CESER&dirEntryId=348941

USEPA (n.d.). Arsenic Mitigation Strategies. Retrieved from: <https://www.epa.gov/sites/default/files/2015-09/documents/train5-mitigation.pdf>

US EPA. (2007). COST EVALUATION OF POINT-OF-USE AND POINT-OF-ENTRY TREATMENT UNITS FOR SMALL SYSTEMS: COST ESTIMATING TOOL AND USER GUIDE. Retrieved from: <https://www.epa.gov/sites/production/files/2015-04/documents/epa815b07001.pdf>

USEPA. (2006a). Design Manual: Removal of Arsenic from Drinking Water supplies by Iron Removal Process. Retrieved from: <https://nepis.epa.gov/Exe/ZyNET.exe/2000D2G2.TXT>

US EPA. (2021a). Drinking Water Treatment Technology Unit Cost Models. Retrieved from: <https://www.epa.gov/sdwa/drinking-water-treatment-technology-unit-cost-models>

USEPA (2011). Exposure Factors Handbook. Retrieved from: <https://cfpub.epa.gov/ncea/risk/recordisplay.cfm?deid=236252>

US EPA. (2020a). Exposure Assessment Tools by Routes – Inhalation. Retrieved from: <https://www.epa.gov/expobox/exposure-assessment-tools-routes-inhalation>

US EPA. (2020b). Exposure Assessment Tools by Routes – Dermal. Retrieved from: <https://www.epa.gov/expobox/exposure-assessment-tools-routes-dermal>

US EPA. (1992). Guidelines for Exposure Assessment. Retrieved from: https://www.epa.gov/sites/production/files/2014-11/documents/guidelines_exp_assessment.pdf

US EPA Integrated Risk Information System [IRIS]. (1991). Arsenic, inorganic; CASRN 7440-38-2. Retrieved from: https://iris.epa.gov/static/pdfs/0278_summary.pdf

US EPA Integrated Risk Information System [IRIS]. (2021b). Nitrate: CASRN 14797-55-8 | DTXSID5024217. Retrieved from: https://cfpub.epa.gov/ncea/iris2/chemicalLanding.cfm?substance_nmbr=76.

US EPA Integrated Risk Information System [IRIS]. (1989). Uranium, soluble salts; no CASRN. Retrieved from: https://cfpub.epa.gov/ncea/iris/iris_documents/documents/subst/0421_summary.pdf

USEPA (1978). Nitrate Removal from Water Supplies by Ion Exchange. Retrieved from: <https://nepis.epa.gov/Exe/ZyNET.exe/9101MNNX.TXT>

USEPA. (2006b) Point-of-Use or Point-of-Entry Treatment Options for Small Drinking Water Systems Retrieved from: https://www.epa.gov/sites/production/files/2015-09/documents/guide_smallsystems_pou-poe_june6-2006.pdf

USEPA (2003a). Removal of Arsenic from Drinking Water by Adsorptive Media. Retrieved from: <https://nepis.epa.gov/Exe/ZyNET.exe/30002K50.TXT>

USEPA (2003b). Removal of Arsenic from Drinking Water by Ion Exchange. Retrieved from: <https://nepis.epa.gov/Exe/ZyNET.exe/30002KZR.TXT>

USEPA (2017a). Safe Drinking Water Information System [SDWIS] Federal Reporting Services. Retrieved from: <https://www.epa.gov/ground-water-and-drinking-water/safe-drinking-water-information-system-sdwis-federal-reporting>

USEPA. (2020c). Tool for Reduction and Assessment of Chemicals and Other Environmental Impacts (TRACI). Retrieved from: <https://www.epa.gov/chemical-research/tool-reduction-and-assessment-chemicals-and-other-environmental-impacts-traci>

US EPA. (2021c). Work Breakdown Structure-Based Cost Model for Adsorptive Media Drinking Water Treatment. *Personal communication*.

US EPA. (2017b). Work Breakdown Structure-Based Cost Model for Anion Exchange Drinking Water Treatment. Retrieved from: <https://www.epa.gov/sdwa/drinking-water-treatment-technology-unit-cost-models>

Water Quality Association. (2021). *Find WQA-Certified Water Treatment Products*. Retrieved from: <https://www.wqa.org/find-products#/keyword/?claims=121>. [26 January 2021]

Zhou, J., You, Y., Bai, Z., Hu, Y., Zhang, J., & Zhang, N. (2011). Health risk assessment of personal inhalation exposure to volatile organic compounds in Tianjin, China. *Science of The Total Environment*, 409(3), 452–459. <https://doi.org/10.1016/j.scitotenv.2010.10.022>

Zhou, Y., Benson, J. M., Irvin, C., Irshad, H., & Cheng, Y.-S. (2007). Particle Size Distribution and Inhalation Dose of Shower Water Under Selected Operating Conditions. *Inhalation Toxicology*, 19(4), 333–342. <https://doi.org/10.1080/08958370601144241>

Appendix A: Selected technology process flow diagrams

Figure A1: Centralized adsorptive media for Region 1

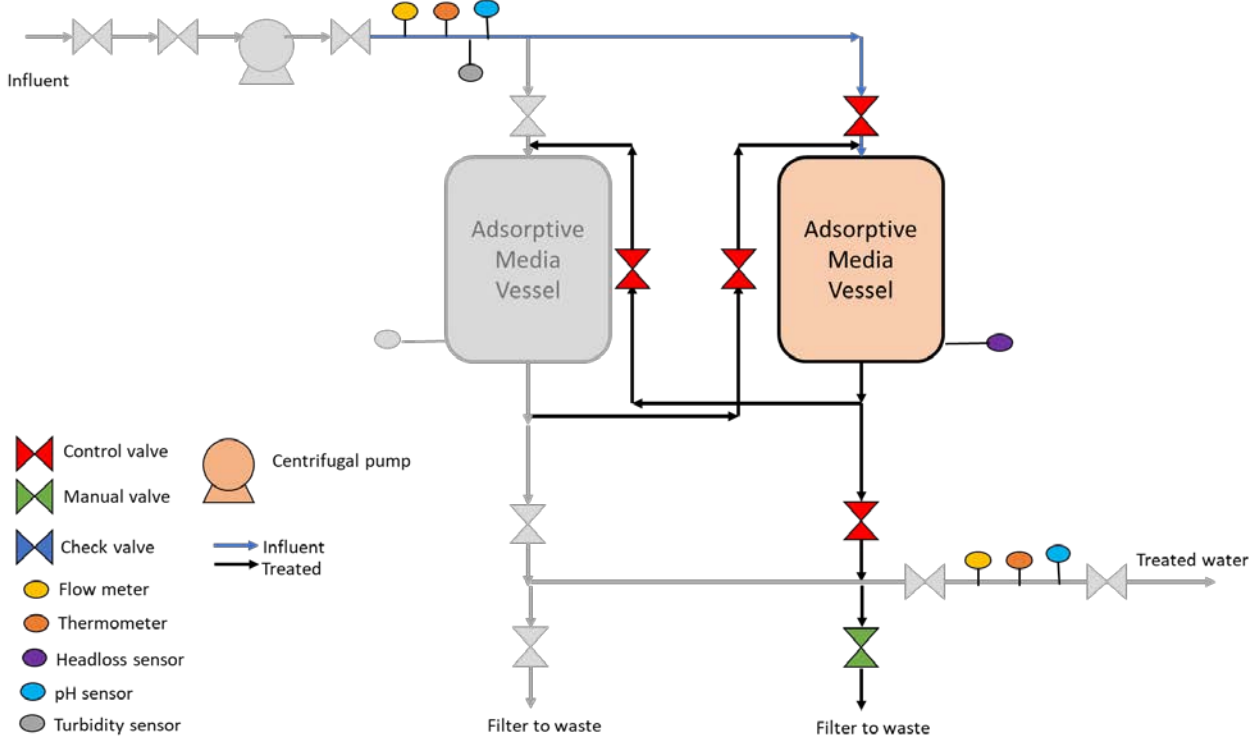

Figure A2: Centralized pre-oxidation modifications for Region 5

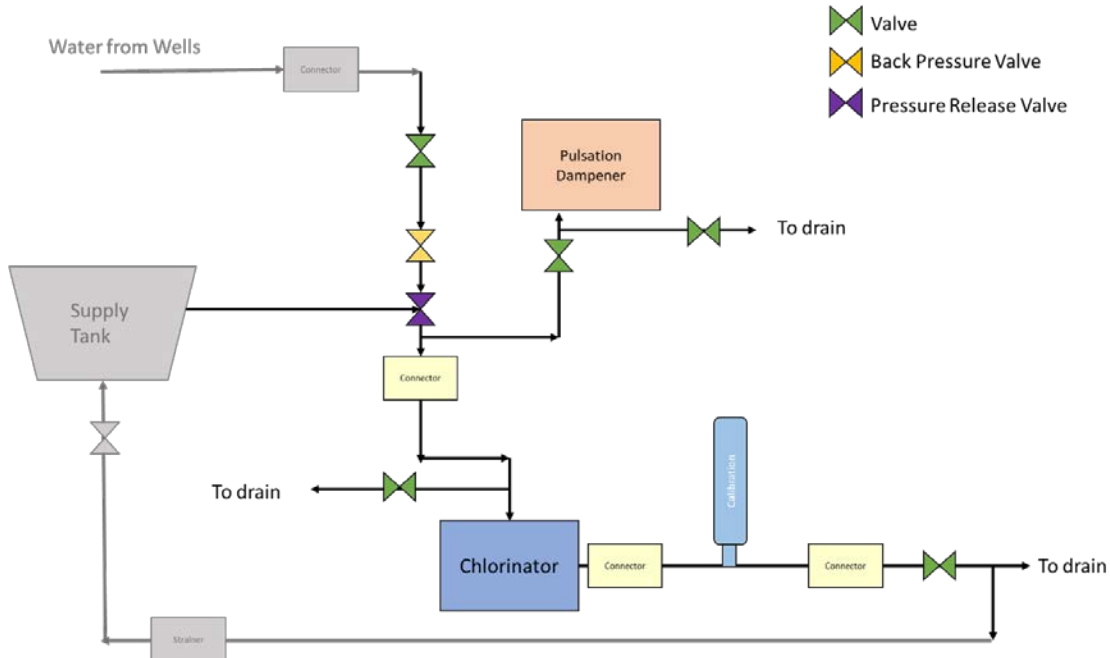

Figure A3: Centralized anion exchange process for Region 7 and Region 9

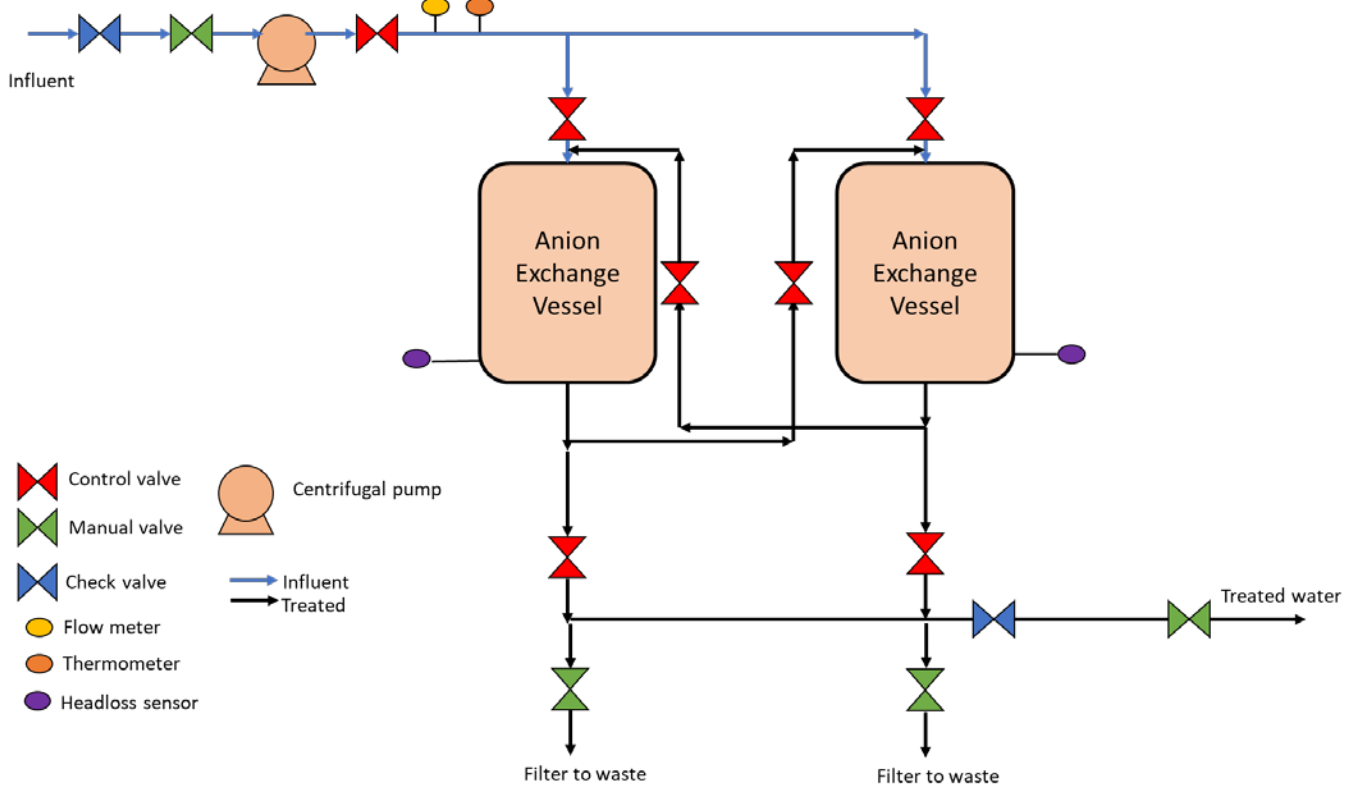

Figure A4: POE Adsorptive Media process flow (Region 5)

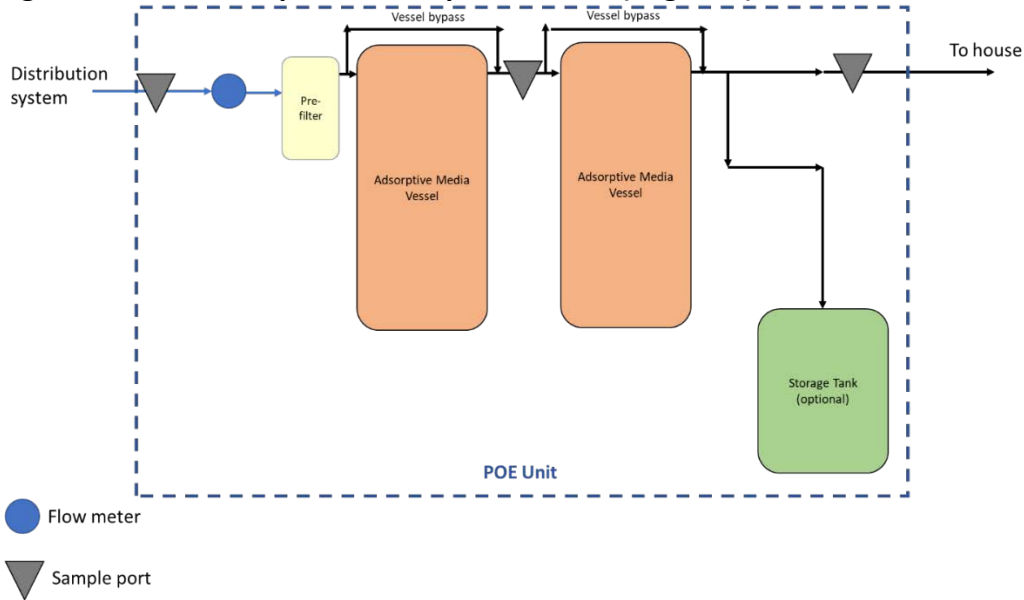
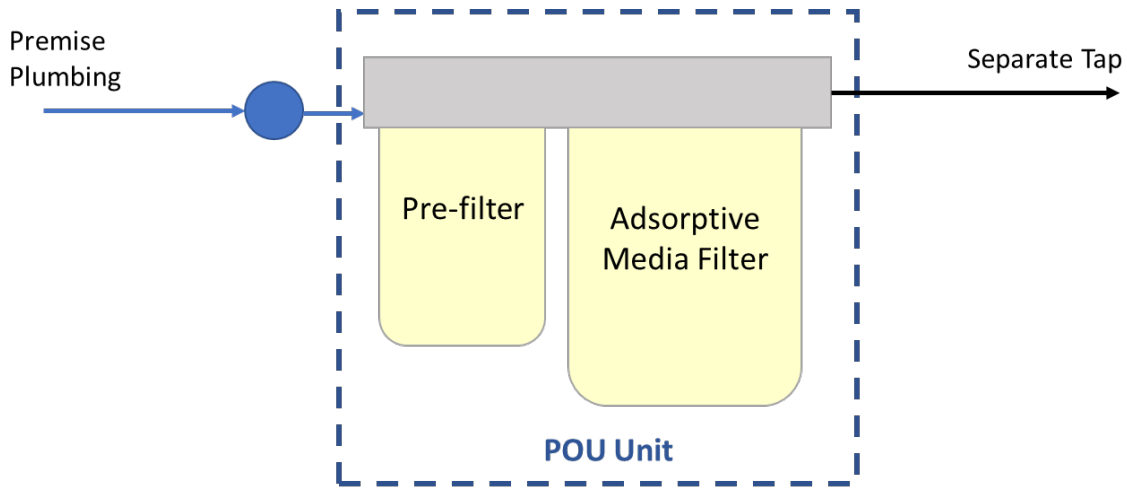
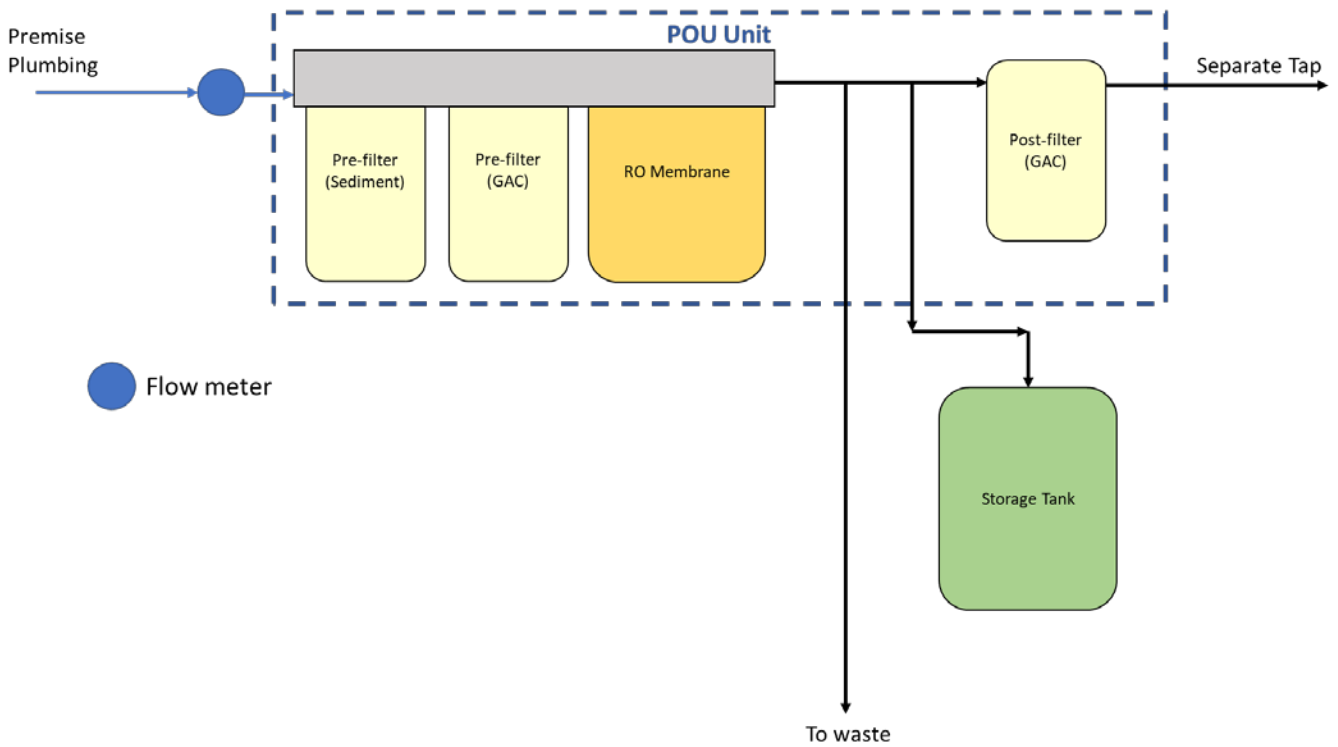

Figure A5: POU Adsorptive media device (Region 1 and Region 9)



● Flow meter

Figure A6: Process flow diagram of POU RO devices (Region 1, Region 7 and Region 9)



● Flow meter

Appendix B: POU and POE Device Listings

Table B1: Eligible POU devices certified to NSF/ANSI 53

Company Name	Device	Device Type	Service Cycle (gallons)	Cost Information
Company A	Device A1	Plumbed-In	600	Retail is \$550, cost of replacements is approximately \$125
	Device A2	Plumbed-In	600	
Company B	Device B1	Plumbed-In	500	Unit = \$1035, with no additional kits (additional kits are \$45 for the countertop kit and \$45 for the below the sink kit US Continental Shipping = \$15.50 Replacement filter = \$150, \$10 shipping
	Device B2	Plumbed-In	600	Model XXXX Device = \$740, shipping = \$13.00 Replacement filter = \$150, \$10 shipping
Company C	Device C1	Plumbed-In to Separate Tap	600	Three different models

Table B2: Eligible POU devices certified to NSF /ANSI 58

Company	Model Number	Type of Device	Daily Production Rate (gpd)	Claim	Certification
Company D	Device D1	Plumbed-In to Separate Tap	11	Nitrate/Nitrite Reduction, Arsenic Pentavalent <= 300 ppb Reduction	NSF/ANSI 58
Company E	Device E1	Plumbed-In to Separate Tap	15.75	Nitrate/Nitrite Reduction, Arsenic Pentavalent <= 300 ppb Reduction	NSF/ANSI 58

Company F	Device F1	Plumbed-In to Separate Tap	11	Nitrate/Nitrite Reduction, Arsenic Pentavalent <= 300 ppb Reduction	NSF/ANSI 58
Company G	Device G1	Plumbed-In to Separate Tap	11	Nitrate/Nitrite Reduction, Arsenic Pentavalent <= 300 ppb Reduction	NSF/ANSI 58
Company H	Device H1	Plumbed-In to Separate Tap	11	Nitrate/Nitrite Reduction, Arsenic Pentavalent <= 300 ppb Reduction	NSF/ANSI 58
Company I	Device I1	Plumbed-In to Separate Tap	11	Nitrate/Nitrite Reduction, Arsenic Pentavalent <= 300 ppb Reduction	NSF/ANSI 58

Table B3: Eligible certified POE devices

Company Name	Device	Technology Type	Certifications
Company J	Device J1	RO	CSA B483.1 – 2007
Company K	Device K1	Adsorptive Media (GFH)	CSA B483.1 – 2007 NSF/ANSI 53
	Device K2	Adsorptive Media (GFH)	CSA B483.1 – 2007 NSF/ANSI 53
	Device K3	Adsorptive Media (GFH)	CSA B483.1 – 2007 NSF/ANSI 53
Company L	Device L1	RO	CSA B483.1 – 2007
	Device L2	RO	CSA B483.1 – 2007
Company M	Device M1	RO	CSA B483.1 – 2007

Company N	Device N1	Adsorptive Media (GFH)	NSF/ANSI 61
	Device N2	Adsorptive Media (GFH)	NSF/ANSI 61
	Device N3	Adsorptive Media (GFH)	NSF/ANSI 61
	Device N4	Adsorptive Media (GFH)	NSF/ANSI 61

Table B4: NSF Listings as of January 2021

NSF/ANSI Standard	Performance Claim	# of Companies	# of Products
NSF/ANSI 58 (RO)	Pentavalent Arsenic ≤ 50 ppb*	5	19
NSF/ANSI 58 (RO)	Pentavalent Arsenic ≤ 300 ppb	30	135
NSF/ANSI 53 (Health Effects)	Pentavalent Arsenic ≤ 50 ppb*	4	6
NSF/ANSI 58 (RO)	Nitrate/Nitrite	23	104

Appendix C: Exposure Assessment

Methods for Inhalation Exposure

Inhalation.

Calculations. Chronic daily intake for the inhalation exposure route can be calculated using the following equation (US EPA, 2020a):

$$CDI = \frac{C_{air} * InhR * ED * EF}{BW * LT} \quad (3.5)$$

In Equation 3.5, *InhR* represents the inhalation rate in m³/hour, *C_{air}* represents the concentration of the contaminant in air in mg/m³. The remaining variables are the same as Equation 3.1, and we used the same deterministic values to calculate chronic daily intake (Table 3.1).

Input values. An inhalation rate (*InhR*) of 16 m³/day was used for adults (both male and female) from the US EPA Exposure Factors Handbook, *InhR* of 15 m³/day for teenagers, and *InhR* 5 m³/day for infants (US EPA, Chapter 6, 2011). The *C_{air}* was calculated by finding the total volume of water inhaled during a 15-minute bathing event. Zhou et.al. calculated the total volume of water inhaled during a ten- minute shower to be 0.5 m³. From this value, we calculated the total volume inhaled during a 15- minute bathing event as 0.75 m³. Using a total showering volume of 90 L (based on a flow rate of 6 L/min and exposure time of 15 minutes), we determined an equation to relate the concentration and volume of water from the shower to the volume inhaled and then solved for the concentration in air.

Table C1: Literature values for health effects from the contaminants of concern considered in this study.

Contaminant	Intake Values (mg/kg/day)	Health Effects
Arsenic*	0.01 – 0.1	Hyperpigmentation, Hyperkeratosis
	>0.01	GI concerns, Liver damage
	>0.05	Hematological
	0.01-0.03	Neurological (peripheral neuropathy)
	0.014 – 0.065	Cardiovascular
	0.02-0.06	Increase in Raynaud’s disease, cyanosis of fingers and toes

*Source: USEPA Integrated Risk Information System [IRIS]. (2020). Arsenic, inorganic; CASRN 7440-38-2

Table C2: Literature values for the removal of arsenic via POU or POE devices

Study	Location (s)	POU or POE	Technology	Sample Size	Arsenic Removal
Yang et. al. 2020	New Jersey Maine	POE (NJ) POU (ME)	RO POU Dual Tank Adsorption (NJ)		ME: mean reduction from 105 to 14.3 µg/L NJ: mean reduction from 15.8 to 2.1 µg/L
Walker et.al. 2005	Nevada	POU	47% of homes had RO or distillation	134 homes	50% of homes still had As > 13 µg/L
George et.al. 2006	Nevada	POU	RO	19 homes	10 homes still had As > 10 µg/L at end of study period
Walker et.al. 2008	Nevada	POU	RO	59 homes	Average As removal = 80%, 18 homes still had As > 10 µg/L
Slotnick et.al., 2006	Michigan	POU	RO	5 homes	85.5% removal of As, all homes below 10 µg/L

Lothrop et.al., 2015	Arizona		RO Activated Carbon	5 homes for each technology (10 homes total)	81-99% removal with RO, 24-45% removal with AC
Spayd et.al. 2015	New Jersey	8 POE, 4 POU			As removal to below 3 µg/L POE worked better
Rockafellow-Baldoni et.al., 2018	New Jersey	POE		55 homes	51 homes (93 %) treated below NJ MCL of 5 µg/L
Powers et.al. 2019	North Dakota South Dakota	POU	Adsorption (Carbon fiber)	6 homes	As removal to 1 µg/L for at least 9 months
EPA Demo POU Devices		POU	Adsorptive Media (GFH) RO	8 buildings (AM) 9 homes (RO)	For Media: Kinetico units could remove to 6 µg/L As over 1000 gal and AdEdge units could remove to 8 µg/L over 3000 gal

Table C3: AWWARF Project Arsenic removal efficiencies (AWWARF, 2005)

Location	Technology type	Influent arsenic (mg/L)	Influent iron (mg/L)	Influent pH	Effluent arsenic (mg/L)	Effluent pH	Gallons treated to 10 ppb arsenic breakthrough	Removal efficiency
		Arsenic: Iron ratio						
Metrowater, Tuscon, AZ	POU RO	0.011	< 0.05	7.8	<0.002	6.7-8.8	>780	82%
	POU AA	4.5:1			<0.002	7.4-8.8	2660	82%
	POE Fe-AA				<0.001 – 0.01	7.0-7.7	356,400	91%
	POE GFH				<0.001 – 0.025	7.2-7.7	343,400	91%
Sun City West, AZ	POU RO	0.023	0.04	8.4	<0.002	7.1-8.7	>1300	91%
	POU AA	1.74:1			<0.001 – 0.025	7.7-8.4	1780	96%
	POU Mn-AA				<0.001 – 0.026	7.9-8.5	1780	96%
	POE Fe-AA				<0.001 – 0.022	7.2-8.5	63,400	96%
	POE GFH				<0.001 – 0.014	7.2-8.5	368,600	96%

Stagecoach, NV	POE Fe-AA	0.024	0.73	8.2	<0.001 – 0.014	8.0-8.3	34600	42-96%
	POE GFH	30.4:1			<0.001 – 0.009	8.0-8.3	110,000	63-96%
Unity, ME	POU RO	0.098	0.06	8.1	0.053 – 0.1	8.2	NA	46%
	POU Mn-AA	0.61:1			<0.001 – 0.11	8.0 – 8.1	640	99%
Carson City, NV	POU GFH	0.015	< 0.05	8.3	<0.002-0.012	7.7-8.3	15200	20-87%
	POU Mn-AA	3.3:1			<0.002-0.016	8.0-9.0	7700	87%
Houston, TX	POE GFH	0.002	0.16	7.6	<0.001-0.008	6.2-7.8	>328900	64-95%
	POE Fe-AA	7.3:1			<0.001 – 0.014	5.2-7.0	201,450	36-95%

Table C4: Literature values for removal rates for arsenic achieved by POU/POE devices (AWWARF, 2005).

Location	Influent As (mg/L)	Influent Fe (mg/L)	As: Fe Ratio	Influent pH	Gallons treated before 10 ppb breakthrough	POU/POE	Technology	Effluent pH	Removal Rate (%)
Arizona	0.011	<0.05	4.5: 1	7.8	> 780	POU	RO	6.7-8.8	82%
					2660	POU	Activated Alumina	7.4-8.6	82%
					356,400	POE	Iron based adsorptive media	7-7.7	91%
					343,400	POE	Granular ferric hydroxide media	7.2-7.7	91%
Arizona	0.023	0.04	1.74:1	8.4	>1300	POU	RO	7.1-8.7	91%
					1780	POU	Activated Alumina	7.7-8.4	96%
					1780	POU	Manganese based adsorptive media	7.9-8.5	96%
					63,400	POE	Iron based adsorptive media	7.2-8.5	96%
					368,600	POE	Granular ferric	7.2-8.5	96%

							hydroxide media		
Nevada	0.024	0.73	30.4:1	8.2	34,600	POE	Iron based adsorptive media	8-8.3	42-96%
					110000	POE	Granular ferric hydroxide media	8-8.3	63-96%
Maine	0.098	0.06	0.61:1	8.1	NA	POU	RO	8.2	46%
					640	POU	Manganese based adsorptive media	8-8.1	99%
Nevada	0.015	<0.05	3.3:1	8.3	15,200	POU	Granular ferric hydroxide media	7.7-8.3	20-87%
					7,700	POU	Manganese based adsorptive media	8-9	87%
Texas	0.022	0.16	7.3:1	7.6	> 328,900	POE	Iron based adsorptive media	6.2-7.8	64-95%
					201,450	POE	Granular ferric	5.2-7	36-95%

							hydroxide media		
--	--	--	--	--	--	--	--------------------	--	--

Table C5: Arsenic removal efficiencies from Yang et.al., 2020

State	Study	POU/POE	Technology	Sample size	Removal efficiency
NV	Walker et.al., 2005	POU	47% of homes on RO, 53% using distillation	134 homes	50% of homes still had arsenic > 13 ug/L
NV	George et.al., 2006	POU	RO	19 homes	10 homes still had arsenic > 10 ug/L
NV	Walker et.al. 2008	POU	RO	59 homes	Average removal = 80%, 18 homes still had arsenic > 10 ug/L
MI	Slotnick et.al. 2006	POU	RO	5 homes	85.5% removal of arsenic All homes met MCL (10 ug/L)
AZ	Lothrop et.al., 2015	POU	RO	5 homes	81-99% removal of arsenic
			Activated carbon	5 homes	24-45% removal of arsenic
NJ	Spayd et.al., 2015	8 POE 4 POU	Mixture	Not specified	POE devices performed better and removed arsenic below 3 ug/L
NJ	Rockafellow-Baldoni et.al., 2018	POE	Not specified	55 homes	51 homes treated below NJ MCL of 5 ug/L for arsenic
ND and SD	Powers et.al., 2019	POU	Adsorption	6 homes	Arsenic removed to 1 ug/L for at least 9 months before breakthrough
ME	Yang et.al. 2020	POU	RO	Not specified	86 - 99% removal of arsenic on average from 105 ug/L to 14.3 ug/L

NJ	Yang et.al. 2020	POE	Dual tank filtration	Not specified	86-98% removal of arsenic on average from 15.8 ug/L to 2.1 ug/L
----	------------------	-----	----------------------	---------------	---

Table C6: Deterministic CDI values for Region 5

Scenario			Mean Arsenic Concentration (µg/L)	Bodyweight	CDI (ug/kg/day)	Carcinogenic Risk (ug/kg/day)	Hazard Quotient	MLE	# of People per 10,000 people
Pre-Implementation	Centralized	Aeration, pre-chlorination and pressure sand filtration	9.2	Male = 75 kg	0.25	0.37	0.82	1.8E-05	2
				Female = 55 kg	0.33	0.50	1.12	2.5E-05	3
				Child = 15 kg	1.23	1.84	4.09	9.2E-05	9
				Infant = 5 kg	3.68	5.52	12.27	2.8E-04	28
Post-Implementation	Centralized	Pre-chlorination, aeration, filtration (80% Removal)	1.8	Male = 75 kg	0.0491	0.07	0.25	3.7E-06	0.4
				Female = 55 kg	0.0669	0.10	0.33	5.0E-06	0.5
				Child = 15 kg	0.2453	0.37	1.23	1.8E-05	1.8
				Infant = 5 kg	0.7360	1.10	3.68	5.5E-05	5.5
	POE	POE Device K, Adsorptive Media (98%)	0.37	Male = 75 kg	0.0049	0.01	0.02	3.7E-07	0.0
				Female = 55 kg	0.0067	0.01	0.03	5.0E-07	0.1
				Child = 15 kg	0.0245	0.04	0.12	1.8E-06	0.2
				Infant = 5 kg	0.0736	0.11	0.37	5.5E-06	0.6

	POE	POE Device N, Adsorptive Media (95% Removal)	0.46	Male = 75 kg	0.012	0.02	0.06	9.2E-07	0.1
				Female = 55 kg	0.017	0.03	0.08	1.3E-06	0.1
				Child = 15 kg	0.061	0.09	0.31	4.6E-06	0.5
				Infant = 5 kg	0.18	0.28	0.92	1.4E-05	1.4
Best-Case	Centralized	80% Removal	1.8	Male = 75 kg	0.049	0.07	0.25	3.7E-06	0.4
				Female = 55 kg	0.067	0.10	0.33	5.0E-06	0.5
				Child = 15 kg	0.25	0.37	1.23	1.8E-05	1.8
				Infant = 5 kg	0.74	1.10	3.68	5.5E-05	5.5
	POE	96% Removal	0.37	Male = 75 kg	0.0098	0.01	0.05	7.4E-07	0.1
				Female = 55 kg	0.013	0.02	0.07	1.0E-06	0.1
				Child = 15 kg	0.049	0.07	0.25	3.7E-06	0.4
				Infant = 5 kg	0.15	0.22	0.74	1.1E-05	1.1
Worst-Case	Centralized	79% Removal	1.9	Male = 75 kg	0.0515	0.08	0.26	3.9E-06	0.4
				Female = 55 kg	0.0703	0.11	0.35	5.3E-06	0.5
				Child = 15 kg	0.2576	0.39	1.29	1.9E-05	1.9
				Infant = 5 kg	0.7728	1.16	3.86	5.8E-05	5.8
	POE	42% Removal	5.3	Male = 75 kg	0.14	0.21	0.71	1.1E-05	1.1
				Female = 55 kg	0.19	0.29	0.97	1.5E-05	1.5
				Child = 15 kg	0.71	1.07	3.56	5.3E-05	5.3
				Infant = 5 kg	2.13	3.20	10.7	1.6E-04	16.0

Table C7: Deterministic CDI values for Region 7

Scenario			Mean Nitrate Concentration (mg/L)	Bodyweight	CDI (mg/kg/day)	
Pre-Implementation	Centralized	Distribution from Wellhead	9.4	Male = 75 kg	0.25	
				Female = 55 kg	0.34	
				Child = 15 kg	1.25	
				Infant = 5 kg	3.76	
Post-Implementation	Centralized	Anion exchange with nitrate selective resin (95% removal)	0.47	Male = 75 kg	0.013	
				Female = 55 kg	0.017	
				Child = 15 kg	0.063	
				Infant = 5 kg	0.19	
	POU	POU Device D, Reverse Osmosis (70% Removal)	2.8	Male = 75 kg	0.075	
				Female = 55 kg	0.1	
				Child = 15 kg	0.38	
				Infant = 5 kg	1.13	
		POU	POU Device G, Reverse Osmosis (80% removal)	1.9	Male = 75 kg	0.05
					Female = 55 kg	0.068

				Child = 15 kg	0.25
				Infant = 5 kg	0.75
Best-Case	Centralized	95% Removal	0.47	Male = 75 kg	0.013
				Female = 55 kg	0.017
				Child = 15 kg	0.063
				Infant = 5 kg	0.19
	POU	97% Removal	0.28	Male = 75 kg	0.0075
				Female = 55 kg	0.0103
				Child = 15 kg	0.0376
				Infant = 5 kg	0.1128
Worst-Case	Centralized	65% Removal	3.3	Male = 75 kg	0.0877
				Female = 55 kg	0.1196
				Child = 15 kg	0.4387
				Infant = 5 kg	1.3160
	POU	57% Removal	4.0	Male = 75 kg	0.1078
				Female = 55 kg	0.1470
				Child = 15 kg	0.5389
				Infant = 5 kg	1.6168

Table C8: Deterministic CDI for Region 9

Scenario			Mean Arsenic Concentration ($\mu\text{g}/\text{L}$)	Bodyweight	CDI ($\text{ug}/\text{kg}/\text{day}$)	Carcinogenic Risk ($\text{ug}/\text{kg}/\text{day}$)	Hazard Quotient	MLE	# of People per 10,000 people
Pre-Implementation	Centralized	Adsorptive Media Filtration (inactive)	19.6	Male = 75 kg	0.52	0.78	2.61	3.9E-05	3.9
				Female = 55 kg	0.71	1.1	3.56	5.3E-05	5.3
				Child = 15 kg	2.61	3.9	13.07	2.0E-04	19.6
				Infant = 5 kg	7.84	11.8	39.20	5.9E-04	58.8
Post-Implementation	Centralized	Anion Exchange with strong base resin (95% removal)	0.98	Male = 75 kg	0.026	0.04	0.13	2.0E-06	0.2
				Female = 55 kg	0.036	0.05	0.18	2.7E-06	0.3
				Child = 15 kg	0.13	0.20	0.65	9.8E-06	1.0
				Infant = 5 kg	0.39	0.59	1.96	2.9E-05	2.9
	POU	POU Device B,	0.2	Male = 75 kg	0.0052	0.01	0.03	3.9E-07	0.0

		Adsorptive Media (99% Removal)		Female = 55 kg	0.0071	0.01	0.04	5.3E-07	0.1
				Child = 15 kg	0.026	0.04	0.13	2.0E-06	0.2
				Infant = 5 kg	0.078	0.12	0.39	5.9E-06	0.6
	POU	POU Device D, Reverse Osmosis (97% Removal)	0.59	Male = 75 kg	0.016	0.02	0.08	1.2E-06	0.1
				Female = 55 kg	0.021	0.03	0.11	1.6E-06	0.2
				Child = 15 kg	0.078	0.12	0.39	5.9E-06	0.6
				Infant = 5 kg	0.24	0.35	1.18	1.8E-05	1.8
	Best-Case	Centralized	95% Removal	0.98	Male = 75 kg	0.026	0.04	0.13	2.0E-06
Female = 55 kg					0.036	0.05	0.18	2.7E-06	0.3
Child = 15 kg					0.13	0.20	0.65	9.8E-06	1.0
Infant = 5 kg					0.39	0.59	1.96	2.9E-05	2.9
POU		96% Removal	0.78	Male = 75 kg	0.021	0.03	0.10	1.6E-06	0.2

				Female = 55 kg	0.029	0.04	0.14	2.1E-06	0.2
				Child = 15 kg	0.105	0.16	0.52	7.8E-06	0.8
				Infant = 5 kg	0.31	0.47	1.57	2.4E-05	2.4
Worst-Case	Centralized	40% Removal	11.8	Male = 75 kg	0.3136	0.47	1.57	2.4E-05	2.4
				Female = 55 kg	0.4276	0.64	2.14	3.2E-05	3.2
				Child = 15 kg	1.5680	2.35	7.84	1.2E-04	11.8
				Infant = 5 kg	4.7040	7.06	23.52	3.5E-04	35.3
	POU AM	68% Removal	14.7	Male = 75 kg	0.42	0.63	2.09	3.1E-05	3.1
				Female = 55 kg	0.57	0.86	2.9	4.3E-05	4.3
				Child = 15 kg	2.09	3.14	10.5	1.6E-04	15.7
				Infant = 5 kg	6.27	9.41	31.4	4.7E-04	47.0

Table C9: Uranium deterministic exposure for Region 9

Scenario			Mean Uranium Concentration (µg/L)	Bodyweight	CDI (ug/kg/day)	Carcinogenic Risk (ug/kg/day)	Hazard Quotient	MLE	# of People per 10,000 people
Pre-Implementation	Centralized	Adsorptive Media Filtration (inactive)	21.5	Male = 75 kg	0.5733	0.57	0.19	2.9E-05	2.9
				Female = 55 kg	0.7818	0.78	0.26	3.9E-05	3.9
				Child = 15 kg	2.8667	2.87	0.96	1.4E-04	14.3
				Infant = 5 kg	8.6000	8.60	2.87	4.3E-04	43.0
Post-Implementation	Centralized	Anion Exchange with strong base resin (95% removal)	1.075	Male = 75 kg	0.0287	0.03	0.01	1.4E-06	0.1
				Female = 55 kg	0.0391	0.04	0.01	2.0E-06	0.2
				Child = 15 kg	0.1433	0.14	0.05	7.2E-06	0.7
				Infant = 5 kg	0.4300	0.43	0.14	2.2E-05	2.2
Best-Case	Centralized	99% Removal	0.215	Male = 75 kg	0.0057	0.01	0.00	2.9E-07	0.0
				Female = 55 kg	0.0078	0.01	0.00	3.9E-07	0.0

				Child = 15 kg	0.0287	0.03	0.01	1.4E-06	0.1
				Infant = 5 kg	0.0860	0.09	0.03	4.3E-06	0.4
	POU	50% Removal	10.75	Male = 75 kg	0.2867	0.29	0.10	1.4E-05	1.4
				Female = 55 kg	0.3909	0.39	0.13	2.0E-05	2.0
				Child = 15 kg	1.4333	1.43	0.48	7.2E-05	7.2
				Infant = 5 kg	4.3000	4.30	1.43	2.2E-04	21.5
	Worst-Case	Centralized	99% Removal	0.215	Male = 75 kg	0.0057	0.01	0.00	2.9E-07
Female = 55 kg					0.0078	0.01	0.00	3.9E-07	0.0
Child = 15 kg					0.0287	0.03	0.01	1.4E-06	0.1
Infant = 5 kg					0.0860	0.09	0.03	4.3E-06	0.4
POU		90% Removal	2.15	Male = 75 kg	0.0573	0.06	0.02	2.9E-06	0.3
				Female = 55 kg	0.0782	0.08	0.03	3.9E-06	0.4
				Child = 15 kg	0.2867	0.29	0.10	1.4E-05	1.4

				Infant = 5 kg	0.8600	0.86	0.29	4.3E- 05	4.3
--	--	--	--	------------------	--------	------	------	-------------	-----

Table C10: Probabilistic CDI values for Region 5

Pre-implementation							
	Bodyweight	Central Tendency	Reasonable Worst-Case Exposure (Lower Bound)	95th Percentile	Maximum Exposure	Maximum Exposure (Upper Bound)	Bounding Estimate
	Male	0.068	0.290	0.412	0.608	0.772	1.722
	Female	0.092	0.397	0.561	0.813	1.058	2.368
Post-implementation							
Removal Rate							
42% Removal	Male	0.143	0.189	0.201	0.212	0.222	0.264
	Female	0.195	0.258	0.276	0.290	0.311	0.364
	Child	0.711	0.947	1.017	1.086	1.126	1.280
	Infant	2.151	2.951	3.177	3.436	3.668	4.390
79% Removal	Male	0.052	0.068	0.073	0.077	0.081	0.096
	Female	0.071	0.093	0.100	0.105	0.113	0.132
	Child	0.257	0.343	0.368	0.393	0.408	0.463
	Infant	0.779	1.068	1.150	1.244	1.328	1.589
80% Removal	Male	0.049	0.065	0.069	0.073	0.077	0.091
	Female	0.067	0.089	0.095	0.100	0.107	0.125
	Child	0.245	0.327	0.351	0.375	0.388	0.441
	Infant	0.742	1.018	1.095	1.185	1.265	1.514
95% Removal	Male	0.012	0.016	0.017	0.018	0.019	0.023

	Female	0.017	0.022	0.024	0.025	0.027	0.031
	Child	0.061	0.082	0.088	0.094	0.097	0.110
	Infant	0.185	0.254	0.274	0.296	0.316	0.378
96% Removal	Male	0.010	0.013	0.014	0.015	0.015	0.018
	Female	0.013	0.018	0.019	0.020	0.021	0.025
	Child	0.049	0.065	0.070	0.075	0.078	0.088
	Infant	0.148	0.204	0.219	0.237	0.253	0.303
98% Removal	Male	0.195	0.258	0.276	0.290	0.311	0.364
	Female	0.007	0.009	0.010	0.010	0.011	0.013
	Child	0.025	0.033	0.035	0.037	0.039	0.044
	Infant	0.074	0.102	0.110	0.118	0.126	0.151

Table C11: Probabilistic CDI values for Region 7

Pre-implementation									
	Bodyweight	Central Tendency	Reasonable Worst-Case Exposure (Lower Bound)	95th Percentile	Maximum Exposure	Maximum Exposure (Upper Bound)	Bounding Estimate		
			Male	0.248	0.330	0.356	0.375	0.391	0.425
			Female	0.336	0.452	0.483	0.515	0.525	0.587
Post-implementation									
Removal Rate									
10% Removal	Male	0.223	0.297	0.321	0.338	0.352	0.382		
	Female	0.302	0.407	0.435	0.463	0.473	0.529		
	Child	1.112	1.480	1.604	1.720	1.778	1.951		
	Infant	3.358	4.648	4.975	5.460	5.728	6.973		
65% Removal	Male	0.087	0.116	0.125	0.131	0.137	0.149		

	Female	0.118	0.158	0.169	0.180	0.184	0.206
	Child	0.432	0.576	0.624	0.669	0.692	0.759
	Infant	1.306	1.807	1.935	2.123	2.228	2.712
70% Removal	Male	0.074	0.099	0.107	0.113	0.117	0.127
	Female	0.101	0.136	0.145	0.154	0.158	0.176
	Child	0.371	0.493	0.535	0.573	0.593	0.650
	Infant	1.119	1.549	1.658	1.820	1.909	2.324
80% Removal	Male	0.050	0.066	0.071	0.075	0.078	0.085
	Female	0.067	0.090	0.097	0.103	0.105	0.117
	Child	0.247	0.329	0.356	0.382	0.395	0.434
	Infant	0.746	1.033	1.106	1.213	1.273	1.549
90% Removal	Male	0.025	0.033	0.036	0.038	0.039	0.042
	Female	0.034	0.045	0.048	0.051	0.053	0.059
	Child	0.124	0.164	0.178	0.191	0.198	0.217
	Infant	0.373	0.516	0.553	0.607	0.636	0.775
97% Removal	Male	0.007	0.010	0.011	0.011	0.012	0.013
	Female	0.010	0.014	0.014	0.015	0.016	0.018
	Child	0.037	0.049	0.053	0.057	0.059	0.065
	Infant	0.112	0.155	0.166	0.182	0.191	0.232

Table C12: Probabilistic CDI values for Region 9

Pre-implementation							
	Bodyweight	Central Tendency	Reasonable Worst-Case Exposure (Lower Bound)	95th Percentile	Maximum Exposure	Maximum Exposure (Upper Bound)	Bounding Estimate
	Male	0.14	0.52	0.74	1.53	2.15	3.00
	Female	0.17	0.65	0.93	1.90	2.71	3.71
Post-implementation							
Removal Rate							
45% Removal	Male	0.315	0.414	0.437	0.466	0.481	0.523
	Female	0.431	0.562	0.603	0.637	0.653	0.743
	Child	1.589	2.075	2.207	2.356	2.439	2.682
	Infant	4.704	6.416	6.950	7.618	8.111	9.161
95% Removal	Male	0.026	0.035	0.036	0.039	0.040	0.044
	Female	0.036	0.047	0.050	0.053	0.054	0.062
	Child	0.132	0.173	0.184	0.196	0.203	0.224
	Infant	0.392	0.535	0.579	0.635	0.676	0.763
96% Removal	Male	0.021	0.028	0.029	0.031	0.032	0.035
	Female	0.029	0.037	0.040	0.042	0.044	0.050
	Child	0.106	0.138	0.147	0.157	0.163	0.179
	Infant	0.235	0.321	0.348	0.381	0.406	0.458
97% Removal	Male	0.016	0.021	0.022	0.023	0.024	0.026
	Female	0.022	0.028	0.030	0.032	0.033	0.037
	Child	0.079	0.104	0.110	0.118	0.122	0.134
	Infant	0.235	0.321	0.348	0.381	0.406	0.458
99% Removal	Male	0.005	0.007	0.007	0.008	0.008	0.009
	Female	0.007	0.009	0.010	0.011	0.011	0.012
	Child	0.026	0.035	0.037	0.039	0.041	0.045

	Infant	0.078	0.107	0.116	0.127	0.135	0.153
--	--------	-------	-------	-------	-------	-------	-------

Table C13: Probabilistic uranium removal in Region 9

Pre-implementation							
	Bodyweight	Central Tendency	Reasonable Worst-Case Exposure (Lower Bound)	95th Percentile	Maximum Exposure	Maximum Exposure (Upper Bound)	Bounding Estimate
	Male	0.67	0.90	0.95	1.00	1.03	1.18
	Female	0.91	1.22	1.31	1.37	1.43	1.64
Post-implementation							
Removal Rate							
50% Removal	Male	0.33	0.45	0.47	0.50	0.52	0.59
	Female	0.46	0.61	0.65	0.69	0.71	0.82
	Child	1.68	2.23	2.38	2.53	2.64	2.94
	Infant	5.03	6.93	7.43	8.15	8.60	10.20
90% Removal	Male	0.07	0.09	0.09	0.10	0.10	0.12
	Female	0.09	0.12	0.13	0.14	0.14	0.16
	Child	0.34	0.45	0.48	0.51	0.53	0.59
	Infant	1.01	1.39	1.49	1.63	1.72	2.04
95% Removal	Male	0.03	0.04	0.05	0.05	0.05	0.06
	Female	0.05	0.06	0.07	0.07	0.07	0.08
	Child	0.17	0.22	0.24	0.25	0.26	0.29
	Infant	0.50	0.69	0.74	0.81	0.86	1.02
99% Removal	Male	0.01	0.01	0.01	0.01	0.01	0.01
	Female	0.01	0.01	0.01	0.01	0.01	0.02
	Child	0.03	0.04	0.05	0.05	0.05	0.06
	Infant	0.10	0.14	0.15	0.16	0.17	0.20

Table C14: Number of years to implement an alternative for Region 5 removal rates for a male bodyweight of 75 kg. TCR values > NOAEL and Hazard quotient values > 1 are highlighted in red.

Number of years to implement	Total Carcinogenic Risk (ug/kg/day)				Hazard Quotient			
	Removal Rate				Removal Rate			
	96%	95%	80%	42%	96%	95%	80%	42%
0	0.01	0.02	0.07	0.21	0.0	0.1	0.2	0.7
1	0.03	0.03	0.08	0.22	0.1	0.1	0.3	0.7
2	0.04	0.04	0.09	0.22	0.1	0.1	0.3	0.7
3	0.05	0.05	0.10	0.23	0.2	0.2	0.3	0.8
4	0.06	0.07	0.11	0.23	0.2	0.2	0.4	0.8
5	0.07	0.08	0.12	0.24	0.2	0.3	0.4	0.8
6	0.09	0.09	0.13	0.24	0.3	0.3	0.4	0.8
7	0.10	0.10	0.14	0.25	0.3	0.3	0.5	0.8
8	0.11	0.11	0.15	0.25	0.4	0.4	0.5	0.8
9	0.12	0.12	0.16	0.26	0.4	0.4	0.5	0.9
10	0.13	0.13	0.17	0.26	0.4	0.4	0.6	0.9
11	0.14	0.15	0.18	0.27	0.5	0.5	0.6	0.9
12	0.16	0.16	0.19	0.28	0.5	0.5	0.6	0.9
13	0.17	0.17	0.20	0.28	0.6	0.6	0.7	0.9
14	0.18	0.18	0.21	0.29	0.6	0.6	0.7	1.0
15	0.19	0.19	0.22	0.29	0.6	0.6	0.7	1.0
16	0.20	0.20	0.23	0.30	0.7	0.7	0.8	1.0
17	0.21	0.22	0.24	0.30	0.7	0.7	0.8	1.0
18	0.23	0.23	0.25	0.31	0.8	0.8	0.8	1.0
19	0.24	0.24	0.26	0.31	0.8	0.8	0.9	1.0
20	0.25	0.25	0.27	0.32	0.8	0.8	0.9	1.1
21	0.26	0.26	0.28	0.32	0.9	0.9	0.9	1.1

22	0.27	0.27	0.29	0.33	0.9	0.9	1.0	1.1
23	0.29	0.29	0.30	0.33	1.0	1.0	1.0	1.1
24	0.30	0.30	0.31	0.34	1.0	1.0	1.0	1.1
25	0.31	0.31	0.32	0.34	1.0	1.0	1.1	1.1
26	0.32	0.32	0.33	0.35	1.1	1.1	1.1	1.2
27	0.33	0.33	0.34	0.35	1.1	1.1	1.1	1.2
28	0.34	0.34	0.35	0.36	1.1	1.1	1.2	1.2
29	0.36	0.36	0.36	0.36	1.2	1.2	1.2	1.2
30	0.37	0.37	0.37	0.37	1.2	1.2	1.2	1.2

Table C15: Number of years to implement an alternative for Region 7 removal rates for a male bodyweight of 75 kg

Number of years to implement	Average Daily Dose (ug/kg/day)		
	Removal Rate		
	90%	80%	70%
0	0.03	0.05	0.08
1	0.03	0.06	0.08
2	0.04	0.06	0.09
3	0.05	0.07	0.09
4	0.06	0.08	0.10
5	0.06	0.08	0.10
6	0.07	0.09	0.11
7	0.08	0.10	0.12
8	0.09	0.10	0.12
9	0.09	0.11	0.13
10	0.10	0.12	0.13
11	0.11	0.12	0.14

12	0.12	0.13	0.15
13	0.12	0.14	0.15
14	0.13	0.14	0.16
15	0.14	0.15	0.16
16	0.15	0.16	0.17
17	0.15	0.16	0.17
18	0.16	0.17	0.18
19	0.17	0.18	0.19
20	0.18	0.18	0.19
21	0.18	0.19	0.20
22	0.19	0.20	0.20
23	0.20	0.20	0.21
24	0.21	0.21	0.22
25	0.21	0.22	0.22
26	0.22	0.22	0.23
27	0.23	0.23	0.23
28	0.24	0.24	0.24
29	0.24	0.24	0.24
30	0.25	0.25	0.25

Table C16: Number of years to implement an alternative for Region 9 removal rates for a male bodyweight of 75 kg. TCR values > NOAEL and Hazard quotient values > 1 are highlighted in red.

Number of years to implement	Total Carcinogenic Risk (ug/kg/day)				Hazard Quotient			
	Removal Rate				Removal Rate			
	95%	99%	97%	96%	95%	99%	97%	96%
0	0.04	0.01	0.02	0.03	0.1	0.0	0.1	0.1
1	0.06	0.03	0.05	0.06	0.2	0.1	0.2	0.2
2	0.09	0.06	0.07	0.08	0.3	0.2	0.2	0.3

3	0.11	0.09	0.10	0.11	0.4	0.3	0.3	0.4
4	0.14	0.11	0.12	0.13	0.5	0.4	0.4	0.4
5	0.16	0.14	0.15	0.16	0.5	0.5	0.5	0.5
6	0.19	0.16	0.18	0.18	0.6	0.5	0.6	0.6
7	0.21	0.19	0.20	0.21	0.7	0.6	0.7	0.7
8	0.24	0.21	0.23	0.23	0.8	0.7	0.8	0.8
9	0.26	0.24	0.25	0.26	0.9	0.8	0.8	0.9
10	0.29	0.27	0.28	0.28	1.0	0.9	0.9	0.9
11	0.31	0.29	0.30	0.31	1.0	1.0	1.0	1.0
12	0.34	0.32	0.33	0.33	1.1	1.1	1.1	1.1
13	0.36	0.34	0.35	0.36	1.2	1.1	1.2	1.2
14	0.39	0.37	0.38	0.38	1.3	1.2	1.3	1.3
15	0.41	0.40	0.40	0.41	1.4	1.3	1.3	1.4
16	0.44	0.42	0.43	0.43	1.5	1.4	1.4	1.4
17	0.46	0.45	0.45	0.46	1.5	1.5	1.5	1.5
18	0.49	0.47	0.48	0.48	1.6	1.6	1.6	1.6
19	0.51	0.50	0.51	0.51	1.7	1.7	1.7	1.7
20	0.54	0.53	0.53	0.53	1.8	1.8	1.8	1.8
21	0.56	0.55	0.56	0.56	1.9	1.8	1.9	1.9
22	0.59	0.58	0.58	0.58	2.0	1.9	1.9	1.9
23	0.61	0.60	0.61	0.61	2.0	2.0	2.0	2.0
24	0.64	0.63	0.63	0.63	2.1	2.1	2.1	2.1
25	0.66	0.65	0.66	0.66	2.2	2.2	2.2	2.2
26	0.68	0.68	0.68	0.68	2.3	2.3	2.3	2.3
27	0.71	0.71	0.71	0.71	2.4	2.4	2.4	2.4
28	0.73	0.73	0.73	0.73	2.4	2.4	2.4	2.4
29	0.76	0.76	0.76	0.76	2.5	2.5	2.5	2.5
30	0.78	0.78	0.78	0.78	2.6	2.6	2.6	2.6

Figure C1: Implementation timeline for Region 5

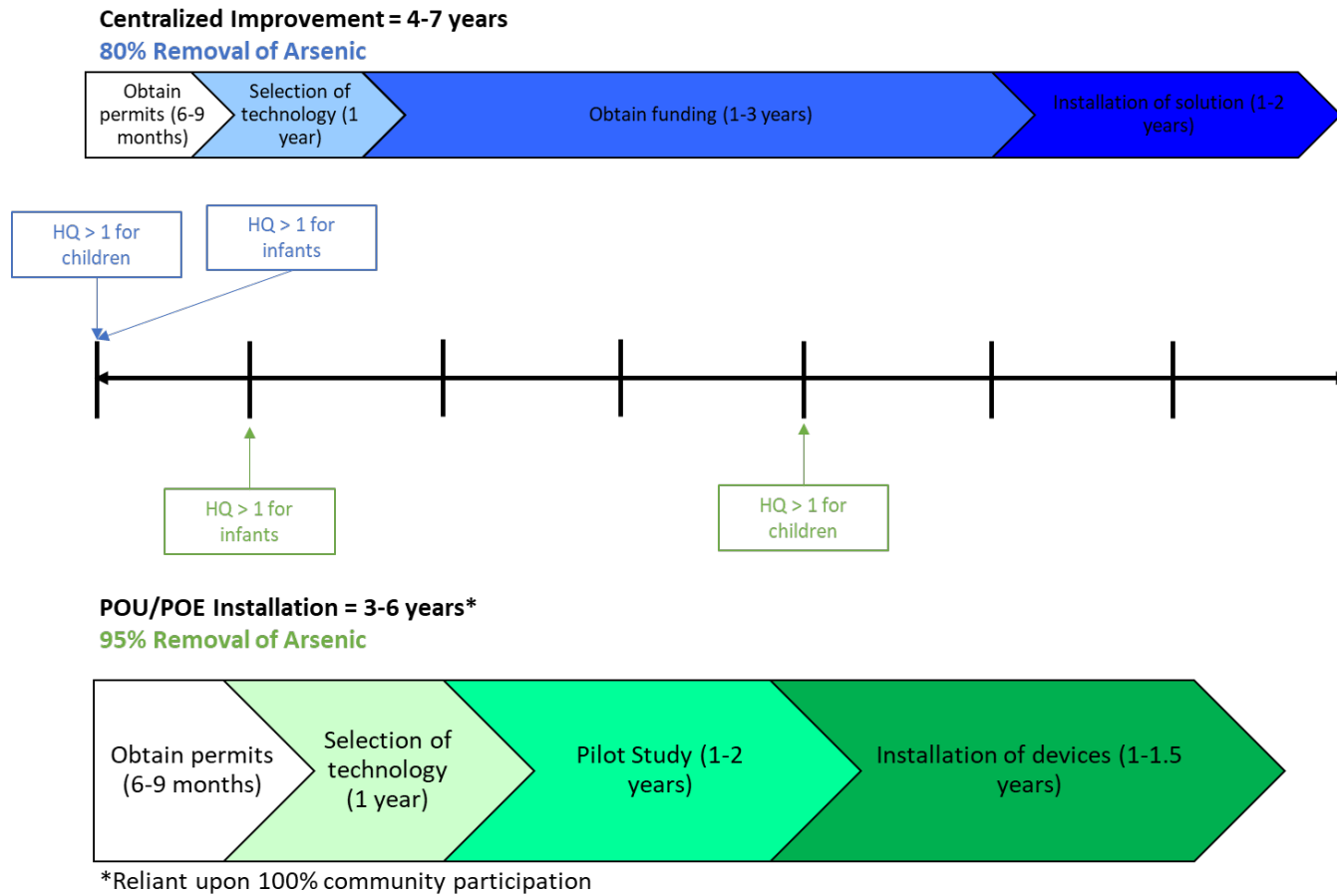
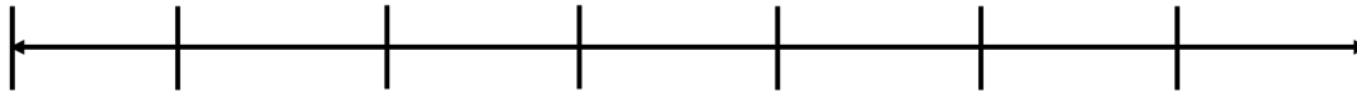

Figure C2: Implementation timeline for Region 7

Centralized Improvement = 4-6 years

90% Removal of Nitrate as N



POU/POE Installation = 3-5 years*

70% Removal of Nitrate as N

Figure C3: Implementation timeline for Region 9

Centralized Improvement = 4-6 years

95% Removal of Arsenic

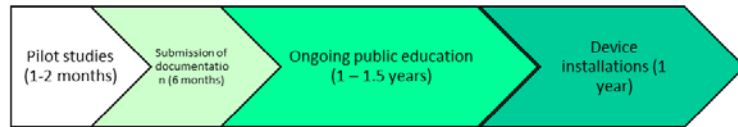
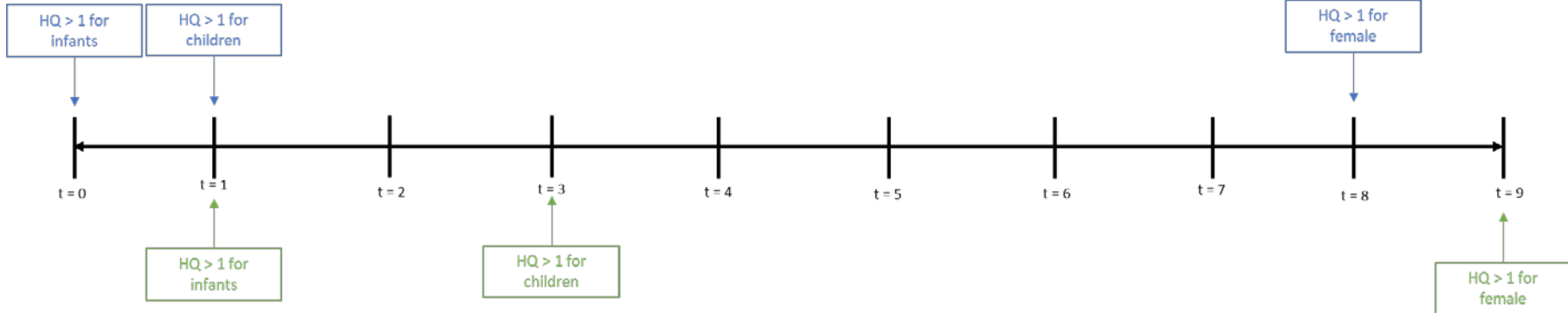

POU/POE Installation = 3-5 years*

99% Removal of Arsenic

Table C17: Dermal exposure calculations for Region 1 are shown for the current concentration of arsenic in the water system. Dermal exposure is quantified separately for arsenite and arsenate because each compound has a different permeability coefficient. We have calculated ADD< CDI, TCR and HQ values as if 100% of the arsenic is in each form. Therefore, the values presented are worst-case estimates of arsenite and arsenate exposure in Region 1.

Bodyweight	Exposure Duration	ARSENITE				ARSENATE			
		ADD (mg/kg/day)	CDI (mg/kg/day)	TCR (mg/kg/day)	HQ	ADD (mg/kg/day)	CDI (mg/kg/day)	TCR (mg/kg/day)	HQ
Male (75 kg)	30	1.18E-03	5.07E-04	3.38E-04	1.13E+00	4.03E-05	1.73E-05	1.15E-05	3.84E-02
Female (55 kg)	30	1.01E-03	4.34E-04	2.90E-04	9.65E-01	3.45E-05	1.48E-05	9.87E-06	3.29E-02
Child (15 kg)	30	9.01E-04	3.86E-04	2.57E-04	8.58E-01	3.07E-05	1.32E-05	8.77E-06	2.92E-02
Infant (5 kg)	30	2.81E-04	1.21E-04	8.04E-05	2.68E-01	9.59E-06	4.11E-06	2.74E-06	9.13E-03

Appendix D: Life Cycle Assessment

Table D1: Inventory of material for POU AM device used in Region 1 and Region 9

Material	Amount of Material (kg) per Device	Initial		30 years	
		Amount of Material for Region 1 (24 homes)	Amount of Material for Region 9 (29 homes)	Amount of Material for Region 1 (24 homes)	Amount of Material for Region 9 (29 homes)
Stainless steel	0.582	13.973	16.884	13.973	16.884
Carbon Fiber	6.012	144.288	174.348	865.729	1046.089
PVC	0.000	0.001	0.001	0.002	0.002

Table D2: Inventory of material for POU RO Device D used in Regions 1, 7 and 9

Material	Amount of Material (kg) per Device	Initial Installation			Over 30 years		
		Amount of Material for Region 1 (24 homes)	Amount of Material for Region 7 (75 homes)	Amount of Material for Region 9 (29 homes)	Amount of Material for Region 1 (24 homes)	Amount of Material for Region 7 (75 homes)	Amount of Material for Region 9 (29 homes)
Fiberglass	0.01	0.33	1.02	0.40	0.33	1.02	0.40
Polypropylene	0.00	0.02	0.06	0.02	0.55	1.71	0.66
Polysulfone	0.00	0.10	0.31	0.12	0.60	1.86	0.72
Stainless Steel	0.86	20.63	64.47	24.93	20.63	64.47	24.93
PVC	0.04	0.96	3.01	1.16	1.70	5.31	2.05
GAC	0.57	13.77	43.03	16.64	413.13	1291.03	499.20

Table D3: Inventory of material for POU RO Device G used in Region 7

Material	Amount of Material (kg) per Device	Initial Installation			Over 30 years		
		Amount of Material for Region 1 (24 homes)	Amount of Material for Region 7 (75 homes)	Amount of Material for Region 9 (29 homes)	Amount of Material for Region 1 (24 homes)	Amount of Material for Region 7 (75 homes)	Amount of Material for Region 9 (29 homes)
Fiberglass	0.01	0.33	1.02	0.40	0.33	1.02	0.40
Polypropylene	0.00	0.02	0.06	0.02	0.55	1.71	0.66
Polysulfone	0.00	0.10	0.31	0.12	0.60	1.86	0.72
Stainless Steel	0.01	0.18	0.57	0.22	0.18	0.57	0.22
PVC	0.00	0.00	0.00	0.00	0.00	0.01	0.00
GAC	0.57	13.77	43.03	16.64	413.13	1291.03	499.20

Table D4: Inventory of material for POE AM Device N used in Region 5

Material	Amount per device (kg)	Initial Amount in Region 5 (221 homes)	Amount over 30 years in Region 5 (221 homes)
granular ferric hydroxide	74.05	16365.47	49096.41
GAC	0.29	63.40	951.06
fiberglass	3268.91	722428.91	722428.91
PVC	0.05	10.90	19.23
rubber	4.67	1031.08	30932.34
gravel	20148.01	4452709.36	13358128.09

Table D5: Inventory of material for POE AM Device K used in Region 5

Material	Amount per device	Initial Amount in Region 5 (221 homes)	Amount over 30 years in Region 5 (221 homes)
PVC	0.05	10.90	19.23
Fiberglass	3268.91	722428.91	722428.91
GFO	3111.42	687624.79	2062874.36
Gravel	570.87	126161.75	378485.24

Table D6: Inventory of raw material for centralized alternative in Region 1

Component	# of Components	Units	Material	Amount of material (kg)	Amount in Region 1 (24 homes)	Amount of material over 30 years (per household)	Amount of material for 24 homes over 30 years
Inlet/outlet piping	20	ft	PVC	18.45	442.73	36.89	885.46
Check valves	2	valve	PVC	0.07	1.67	0.14	3.35
	1	valve	PVC	0.04	0.98	0.08	1.97
Manual valves	2	valve	PVC	0.08	1.97	0.16	3.93
	6	valve	PVC	0.25	5.90	0.49	11.80
	5	valve	PVC	0.23	5.50	0.46	11.01
	3	valve	PVC	0.10	2.51	0.21	5.02
Centrifugal pump	1	pump	Cast iron	203.88	4893.14	407.76	9786.29
Vessel	1	vessel	Fiberglass	7.13	171.10	14.26	342.21
Media	7.6	ft ³	GFH	138.02	3312.38	4278.50	102683.90
Process piping	20	ft	PVC	18.45	442.73	36.89	885.46
residuals piping	50	ft	PVC	28.58	685.83	57.15	1371.66

Table D7: Inventory of raw material for centralized alternative in Region 5

Component	# of Components	Units	Material	Amount of material (kg)	Amount for Region 5 (221 homes)	Amount of material over 30 years (per household)
chemical metering pump	2	pump	PVC	0.29	64.66	0.59
check valves	4	valves	PVC	0.29	64.66	0.29
pressure relief valves	4	valves	PVC	0.29	64.66	0.29
suction tubing	4	ft	PVC	1.17	258.65	7.02
discharge tubing	4	ft	PVC	1.17	258.65	7.02
chemical mixer	1	unit	PVC	10.22	2258.08	10.22
process piping	110	ft	PVC	0.29	64.66	0.29
Dosing pump	1	pump	Cast iron	203.88	45057.77	203.88
eductor	1	eductor	Cast iron	40.78	9011.55	40.78

Table D8: Inventory of raw material for centralized alternative in Region 9

Item	Quantity	Material	Amount of material (kg)	Useful Life (years)	Amount of material per household (29 homes) [kg]	Amount of material per household over 30 years [kg]
Fiber glass pressure vessel	2	Fiberglass	83.28	20	2.87	5.74
Polyacrylic Strong basin resin	34 ft ³	Polyacrylic beads	926.16	1	31.94	31.94
Cartridge filters	2	Carbon fibers	337.30	3	11.63	127.94
PVC process piping	40 ft	PVC	4.80E-08	17	1.65E-09	3.31E-09
PVC Backwash piping	50 ft	PVC	3.52E-08	17	1.21E-09	2.43E-09
PVC inlet + outlet piping	40 ft	PVC	4.60E-08	17	1.59E-09	3.17E-09

PVC process valve (air-powered)	6	PVC	2.88E-10	17	9.92E-12	1.98E-11
PVC inlet + outlet valve (manual)	2	PVC	2.88E-10	17	9.92E-12	1.98E-11
PVC process valve (manual)	2	PVC	2.88E-10	17	9.92E-12	1.98E-11
PVC Backwash valve (air-powered)	7	PVC	1.76E-10	17	6.07E-12	1.21E-11
PVC Residual check vane	1	PVC	2.88E-10	17	9.92E-12	1.98E-11
PVC inlet/outlet valve (check)	2	PVC	2.88E-10	17	9.92E-12	1.98E-11
Stainless steel sample port	5	Stainless steel	1667.09	30	57.49	114.97
Backfill	2 cells	Gravel	1143724.34	30	39438.77	78877.54
Liner	2 cells	Polyethylene	101.42	30	3.50	6.99
Dike Construction	2 cells	Sand	541854.12	15	18684.62	56053.87
solids drying pad	1 unit	Concrete	196.19	30	6.77	13.53
Cartridge filters replacements	2.4	Carbon fibers	0.34	0.42	0.01	0.85
Sodium chloride	4879.679144	Sodium chloride	2215.37	1	76.39	2368.16
Complete bed replacement	5 ft3/yr.	Polyacrylic beads	136.20	1	4.70	140.90
Backwash tank	1 vessel	Fiberglass	0.04	20	0.00	0.00
Backwash rinse pumps	2 pumps	Cast iron	3.27	17	0.11	0.23

Appendix E: Life Cycle Cost

Table E1: Cost Components of the centralized improvement in Region 1

Category of Cost	Subcategory of Cost	Item	Quantity	unit	Unit Cost	Total Cost	Useful Life	Number of Replacements over 30 years	Replacements Rounded	Total cost over 30 years
Direct Capital Cost	Piping	Inlet/outlet piping	20	ft	3	60	17	1.8	1	60
Direct Capital Cost	Valves	Check valves	2	valve	118	236	20	1.5	1	236
Direct Capital Cost	Valves	Check valves	1	valve	178	178	20	1.5	1	178
Direct Capital Cost	Valves	Manual valves	2	valve	265	530	20	1.5	1	530
Direct Capital Cost	Valves	Manual valves	6	valve	265	1590	20	1.5	1	1590
Direct Capital Cost	Valves	Manual valves	5	valve	323.77	1618.85	20	1.5	1	1618.85
Direct Capital Cost	Valves	Manual valves	3	valve	195.93	587.79	20	1.5	1	587.79
Direct Capital Cost	Instrumentation	Flow meter	1	meter	1865	1865	14	2.1	2	3730
Direct Capital Cost	Instrumentation		1	device	2339	2339	14	2.1	2	4678
Direct Capital Cost	Instrumentation	Thermometer	1	device	621	621	14	2.1	2	1242
Direct Capital Cost	Instrumentation	Headloss sensor	1	device	1966	1966	14	2.1	2	3932
Direct Capital Cost	Filter	Vessel	1	vessel	2790	2790	20	1.5	1	2790
Direct Capital Cost	Filter	Media	14	ft^3	187.36	2623.04	10	3.0	3	7869.12
Direct Capital Cost	Piping	Process piping	20	ft	3	60	17	1.8	1	60
Direct Capital Cost	Instrumentation	pH sensor	1	device	2755	2755	14	2.1	2	5510
Direct Capital Cost	Instrumentation	Turbidity sensor	1	device	5466	5466	14	2.1	2	10932

Direct Capital Cost	Piping	residuals piping	50	ft	2	100	17	1.8	1	100
Direct Capital Cost	Instrumentation	high/low alarm	1	unit	620	620	14	2.1	2	1240
Add-on Cost	Administration	Permits				\$253	30	1.0	1	\$253
Add-on Cost	Administration	Pilot Study				\$15,030	30	1.0	1	\$15,030
Indirect Capital Cost	Administration	Site Work				\$1,349	30	1.0	1	\$1,349
Indirect Capital Cost	Administration	Yard Piping				\$1,263	30	1.0	1	\$1,263
Indirect Capital Cost	Administration	Electrical (including yard wiring)				3172.3567	30	1.0	1	\$3,172
Indirect Capital Cost	Administration	Process Engineering				7166.1734	30	1.0	1	\$7,166
Indirect Capital Cost	Administration	Miscellaneous Allowance				3583.0867	30	1.0	1	\$3,583
Indirect Capital Cost	Administration	Legal, Fiscal, and Administrative				716.61734	30	1.0	1	\$717
Indirect Capital Cost	Administration	Construction Management and GC Overhead				1017.5966	30	1.0	1	\$1,018
Annual O&M Cost	Labor	Manager	12.66323	hrs./yr.	48.2	\$610	1	30.0	30	\$18,311.03
Annual O&M Cost	Labor	Administrative	12.66323	hrs./yr.	31.31	\$396	1	30.0	30	\$11,894.57
Annual O&M Cost	Labor	Operator	126.6323	hrs./yr.	32.51	\$4,117	1	30.0	30	\$123,504.50
Annual O&M Cost	Materials	Building and HVAC maintenance (materials and labor)	80	sf	6.16579	\$493	1	30.0	30	\$14,797.90
Annual O&M Cost	Media and Chemicals	Granular Ferric Hydroxide	7.600481	cf/yr.	187.361579	\$1,424	1	30.0	30	\$42,721.15
Annual O&M Cost	Energy	Energy for residuals pumps	0.001561	Mwh/yr.	0.1066	\$0	1	30.0	30	\$4.99
Annual O&M Cost	Energy	Energy for lighting	0.010131	Mwh/yr.	0.1066	\$1	1	30.0	30	\$32.40
Annual O&M Cost	Energy	Energy for ventilation	0.054444	Mwh/yr.	0.1066	\$6	1	30.0	30	\$174.11
Annual O&M Cost	Residuals disposal	Spent media disposal	30%	ton/yr.	\$107	\$32	1	30.0	30	\$958.50
Annual O&M Cost	Residuals disposal	Holding tanks solids disposal	0.003998	ton/yr.	107.1	0.4281383	1	30.0	30	\$12.84

Annual O&M Cost	Miscellaneous	Miscellaneous Allowance	0.1		715.7426128	715.74261	1	30.0	30	715.7426128
-----------------	---------------	-------------------------	-----	--	-------------	-----------	---	------	----	-------------

Table E2: Cost Components of the centralized improvement in Region 5

Component	# of Components	Units	Material	Size	Analogous component in model	Cost per Unit	Total Cost	Useful Life	Number of replacements	Replacements rounded	Total cost over 30 years
chemical metering pump	2	pump	PVC	0.13 gph	4.1.1 PVC Electric pump	467.7490579	935.4981	15	2.0	2.0	1871.0
check valves	4	valves	PVC	0.5 inch diameter pipe	3.3.1 Check valves for chemical feed	70.65770016	282.6308	20	1.5	1.0	282.6
pressure relief valves	4	valves	PVC	0.5 inch diameter pipe	3.1.1 Motor valves for chemical feed	495.6549745	1982.62	20	1.5	1.0	1982.6
suction tubing	4	ft	PVC	Assume 0.5 in diam pipe	Piping from amazon (\$45.99/50ft)	0.92	3.68	5	6.0	6.0	22.1
discharge tubing	4	ft	PVC	Assume 0.5 in diam pipe	Piping from amazon (\$45.99/50ft)	0.92	3.68	5	6.0	6.0	22.1
chemical mixer	1	unit	PVC	3 inch diameter	5.1.1 Plastic mixer	993.6378806	993.6379	22	1.4	1.0	993.6
process piping	110	ft	PVC	0.5 inch diameter pipe	2.1.1 CPVC Process Chemical feed piping	2.708213782	297.9035	17	1.8	1.0	297.9

Table E3: Cost Components of the centralized improvement in Region 7

Component	# of Components	Units	Material	Size	Analogous component in model	Cost per Unit	Total Cost	Useful Life	Number of replacements per 30 years	Num_round	Quantity needed over 30 years
Inlet/outlet piping	-	ft^2	PVC	1.5 in diameter, 40 ft	5.5.1 Inlet/Outlet Piping - PVC	\$2.99	\$119.60	17	1.764705882	1	2
Check valves	2	valve	PVC	1.5 in diameter	6.3.2 Inlet/Outlet Check valve	\$171	\$342	17	1.764705882	1	2
Manual valves	2	valve	PVC	1.5 in diameter	6.2.1 Inlet/Outlet Manual Valves	\$241	\$482	17	1.764705882	1	2
	2	valve	PVC	1.5 in diameter	6.2.2 Process Manual Valve	\$292	\$584	17	1.764705882	1	2

Centrifugal pump	1	pump	Cast iron	1 cu ft	7.1 Booster pump			17	1.764705882	1	2
Control valve	7	valve	PVC	2 in diameter	6.1.1 Process Air Valves	\$682	\$4,774	17	1.764705882	1	2
Vessel	2	vessel	Fiberglass	59 gallons (4.5 ft in height, 1.5 ft diameter)	1.1 Fiber glass pressure vessel	\$2,033	\$4,066	20	1.5	1	2
Resin (polyacrylic beads)	16	ft ³ /yr.	Nitrate Selective Resin	8 ft ³ , bed depth of 2.4 ft	2.1 Nitrate selective resin	\$183.88	\$2,942.08	1	30	30	31
Process piping	-	ft	PVC	2 in diameter, 40 ft	5.3.1 Process Piping - PVC	\$3.30	\$132.00	17	1.764705882	1	2
Backwashing											
Tank	1	vessel	Fiberglass	60 gallons	3.1.1 Fiberglass backwash tank	\$5,489	\$5,489	20	1.5	1	2
Piping	50	ft	PVC	1 inch diameter	5.1.1 Backwash piping (PVC)	\$2.74	\$137.00	17	1.764705882	1	2
motor/ air-operated valves	8	valves	PVC	1 inch diameter	6.1.2 Backwash valves (PVC) - process valves	\$551	\$4,408	20	1.5	1	2
check valves	2	valves	PVC	1 inch diameter	6.3.1 Backwash valves (PVC) - check valves	\$113	\$226	20	1.5	1	2
rinse pumps	2	pumps	Cast iron	6 gpm	7.2 Backwash rinse pumps	\$6,879	\$13,758	17	1.764705882	1	2
Chlorine disinfection											
Storage tank	1	vessel	fiberglass	60 gallons	3.1.1 Fiberglass backwash tank	\$5,489	\$5,489	20	1.5	1	2
chemical metering pump	2	pump	PVC	0.13 gph	4.1.1 PVC Electric pump	467.7490579	935.4981157	15	2.0	2.0	1871.0
check valves	4	valves	PVC	0.5 inch diameter pipe	3.3.1 Check valves for chemical feed	70.65770016	282.6308006	20	1.5	1.0	282.6
pressure relief valves	4	valves	PVC	0.5 inch diameter pipe	3.1.1 Motor valves for chemical feed	495.6549745	1982.619898	20	1.5	1.0	1982.6
suction tubing	4	ft	PVC	Assume 0.5 in diam pipe	Piping from amazon (\$45.99/50ft)	0.92	3.68	5	6.0	6.0	22.1
discharge tubing	4	ft	PVC	Assume 0.5 in diam pipe	Piping from amazon (\$45.99/50ft)	0.92	3.68	5	6.0	6.0	22.1
chemical mixer	1	unit	PVC	3 inch diameter	5.1.1 Plastic mixer	993.6378806	993.6378806	22	1.4	1.0	993.6
process piping	110	ft	PVC	0.5 inch diameter pipe	2.1.1 CPVC Process Chemical feed piping	2.708213782	297.903516	17	1.8	1.0	297.9
Dosing pump	1	pump	Cast iron	1 ft ³	NA	NA	NA	17	1.764705882	1	

Storage											
Small low cost shed	150	ft2	Wood	\$46/ft2		46	6900	20	1.5	1	6900.0
Fiberglass storage tank	1036	gal	Fiberglass	1036 gal			6491	7	4.285714286	4	25964.0
Lab Costs											
Nitrate Samples	4	per year		1 sample location		30.08	120.32	1	30	30	3609.6
Chlorine residual samples	12	per year		2 samples locations		16	384	1	30	30	11520.0

Table E4: Cost Components of the centralized improvement in Region 9

Category of Cost	Subcategory of Cost	Item	Quantity	Size	Unit Cost	Total Cost	Useful Life	Number of Replacements over 30 years	Replacements Rounded	Replacement multiplier	Total Cost over 30 years
Direct Capital Cost	Pressure Vessels	Fiber glass pressure vessel	2	220 gal	\$4,931	\$9,861	20	1.5	1	2	\$4,930.64
Direct Capital Cost	Ion exchange resin	Polyacrylic Strong basin resin	34 ft^3	34 ft^3	\$260.56	\$8,953	10	3	3	4	\$781.68
Direct Capital Cost	Cartridge filters	Cartridge filters	2	0.03 MGD	\$998	\$1,995	30	1	1	2	\$997.58
Direct Capital Cost	Piping	PVC process piping	40 ft	2 in diam	\$3.30	\$132	17	1.764706	1	2	\$3.30
Direct Capital Cost	Piping	PVC Backwash piping	50 ft	1.5 in diam	\$2.99	\$150	17	1.764706	1	2	\$2.99
Direct Capital Cost	Piping	PVC inlet + outlet piping	40 ft	1.5 in diam	\$2.99	\$120	17	1.764706	1	2	\$2.99
Direct Capital Cost	Valves and Fittings	PVC process valve (air-powered)	6	2 in diam	\$682	\$4,091	20	1.5	1	2	\$681.91
Direct Capital Cost	Valves and Fittings	PVC inlet + outlet valve (manual)	2	1.5 in diam	\$241	\$482	20	1.5	1	2	\$240.95

Direct Capital Cost	Valves and Fittings	PVC process valve (manual)	2	2 in diam	\$292	\$584	20	1.5	1	2	\$292.21
Direct Capital Cost	Valves and Fittings	PVC Backwash valve (air-powered)	7	2 in diam	\$613	\$4,292	20	1.5	1	2	\$613.12
Direct Capital Cost	Valves and Fittings	PVC Residual check vale	1	1.5 in diam	\$171	\$171	20	1.5	1	2	\$170.94
Direct Capital Cost	Valves and Fittings	PVC inlet/outlet valve (check)	2	1.5 in diam	\$171	\$342	20	1.5	1	2	\$170.94
Direct Capital Cost	Controls and Instrumentation	Flow meter propeller (input + output)	1	1.5 in diam	\$2,239	\$2,239	14	2.142857	2	3	\$4,477.52
Direct Capital Cost	Controls and Instrumentation	Flow meter propeller (backwash)	1	1.5 in diam	\$2,239	\$2,239	14	2.142857	2	3	\$4,477.52
Direct Capital Cost	Controls and Instrumentation	Flow meter propeller (residuals)	1	1.5 in diam	\$2,239	\$2,239	14	2.142857	2	3	\$4,477.52
Direct Capital Cost	Controls and Instrumentation	High/low alarm	1	NA	\$593	\$593	14	2.142857	2	3	\$1,185.14
Direct Capital Cost	Controls and Instrumentation	Headloss sensors	2	NA	\$2,121	\$4,242	14	2.142857	2	3	\$4,242.19
Direct Capital Cost	Controls and Instrumentation	Stainless steel sample port	5	NA	\$50	\$250	30	1	1	2	\$50.00
Direct Capital Cost	Controls and Instrumentation	PLC racks and power supplies	2	NA	\$340	\$680	8	3.75	3	4	\$1,020.48
Direct Capital Cost	Controls and Instrumentation	CPUs	2	NA	\$628	\$1,256	8	3.75	3	4	\$1,884.61
Direct Capital Cost	Controls and Instrumentation	I/O discrete input modules	1	NA	\$307	\$307	8	3.75	3	4	\$920.62
Direct Capital Cost	Controls and Instrumentation	I/O discrete output modules	1	NA	\$375	\$375	8	3.75	3	4	\$1,124.83

Direct Capital Cost	Controls and Instrumentation	I/O combination analog modules	4	NA	\$653	\$2,611	8	3.75	3	4	\$1,958.03
Direct Capital Cost	Controls and Instrumentation	Ethernet modules	2	NA	\$865	\$1,730	8	3.75	3	4	\$2,595.67
Direct Capital Cost	Controls and Instrumentation	UPSs	1	NA	\$563	\$563	8	3.75	3	4	\$1,689.46
Direct Capital Cost	Controls and Instrumentation	Drive controllers	2	NA	\$1,072	\$2,145	14	2.142857	2	3	\$2,144.87
Direct Capital Cost	Controls and Instrumentation	Operator interface units	2	NA	\$1,956	\$3,911	8	3.75	3	4	\$5,867.19
Direct Capital Cost	Evaporative Ponds	Excavation	2 cells	640 cy	\$19,887.71	\$39,775	10	3	3	4	\$59,663.13
Direct Capital Cost	Evaporative Ponds	Backfill	2 cells	520.5 cy	\$9,220.01	\$18,440	10	3	3	4	\$27,660.02
Direct Capital Cost	Evaporative Ponds	Liner	2 cells	3055.3 ft2	\$5,678.83	\$11,358	10	3	3	4	\$17,036.50
Direct Capital Cost	Evaporative Ponds	Dike Construction	2 cells	258.6 cy	\$2,116.94	\$547,416	10	3	3	4	\$6,350.83
Direct Capital Cost	Evaporative Ponds	solids drying pad	1 unit	1 cy	\$647.97	\$648	37	0.810811	0	1	\$647.97
Add-on Costs	Permits	Permits	NA	NA	23.5	23.5	NA	NA	NA	NA	\$23.50
Add-on Costs	Pilot Study	Pilot Study	NA	NA	15572.82396	15572.82	NA	NA	NA	NA	\$15,572.82
Add-on Costs	Land Cost	Land Cost	NA	NA	5522.818468	5522.818	NA	NA	NA	NA	\$5,522.82
Indirect Capital Costs	Site Work	Site Work	NA	NA	2563.076923	2563.077	NA	NA	NA	NA	\$2,563.08
Indirect Capital Costs	Yard Piping	Yard Piping	NA	NA	1313.646683	1313.647	NA	NA	NA	NA	\$1,313.65

Indirect Capital Costs	Geotechnical	Geotechnical	Na	NA	17870.63266	17870.63	NA	NA	NA	NA	\$17,870.63
Indirect Capital Costs	Electrical Wiring	Electrical Wiring	NA	NA	6716.761125	6716.761	NA	NA	NA	NA	\$6,716.76
Indirect Capital Costs	Process Engineering	Process Engineering	NA	NA	14980.78065	14980.78	NA	NA	NA	NA	\$14,980.78
Indirect Capital Costs	Miscellaneous Allowance	Miscellaneous Allowance	NA	NA	7490.390323	7490.39	NA	NA	NA	NA	\$7,490.39
Indirect Capital Costs	Legal, Fiscal and Administrative	Legal, Fiscal and Administrative	NA	NA	1498.078065	1498.078	NA	NA	NA	NA	\$1,498.08
Indirect Capital Costs	Construction Management + Overhead	Construction Management + Overhead	NA	NA	2127.270852	\$2,127.27	NA	NA	NA	NA	\$2,127.27
Annual O&M	Labor	Manager	9.389324	hr./yr.	45.23962688	\$425	1	30	30	31	\$12,743.09
Annual O&M	Labor	Clerical	9.389324	hr./yr.	30.4776465	\$286	1	30	30	31	\$8,584.94
Annual O&M	Labor	Operator	93.89324	hr./yr.	31.91489117	\$2,997	1	30	30	31	\$89,897.78
Annual O&M	Materials	Cartridge filters replacements	2.4	filter/year	169.5708886	\$407	1	30	30	31	\$12,209.10
Annual O&M	Materials	Building maintenance	140	sf	5.786613273	\$810	1	30	30	31	\$24,303.78
Annual O&M	Chemicals	Sodium chloride	4879.679	lb./yr.	0.147537698	\$720	1	30	30	31	\$21,598.10
Annual O&M	Resin replacement	Complete bed replacement	5	ft3/yr.	260.5605391	\$1,221	1	30	30	31	\$36,644.02
Annual O&M	Energy	Lighting	0	Mwh/yr.	0.121218321	\$2	1	30	30	31	\$60.00
Annual O&M	Energy	Ventilation	0	Mwh/yr.	0.121218321	\$2	1	30	30	31	\$60.00
Annual O&M	Energy	Cooling	0	Mwh/yr.	0.121218321	\$2	1	30	30	31	\$60.00
Annual O&M	Residuals	Spent resin disposal	0.100789	ton/yr.	697.6744186	\$70	1	30	30	31	\$2,109.53

Annual O&M	Residuals	Evaporation pond solids disposal	1.26 9198	ton/y r.	\$75	\$95	1	30	30	31	\$2,852.47
Annual O&M	Residuals	Spent cartridge filter disposal	0%	ton/y r.	74.915 23843	1.43 8373	1	30	30	31	\$43.15
Annual O&M	Miscellaneous Allowance	Miscellaneous Allowance	10%			743. 9783	1	30	30	31	\$743.98

Table E5: Cost Components of the POU AM Device B in Region 1 and 9

Component	Material	Size	Useful life (years)	Cost per unit (\$)
Filter housing	stainless steel	500 gallon capacity, 13" high, 8" wide	30	740
Filter cartridge	carbon fibers		1	145
Inlet pipe	PVC	3/8 inch diameter	17	Included in filter housing cost
Outlet pipe	PVC	1/4 inch diameter	17	Included in filter housing cost
Connector valve	PVC	1/4 inch diameter	1	25
Faucet	stainless steel	0.75 ft high, 10 mm diameter	5	12

Table E6: Cost Components of the POU RO Device D in Region 1, 7 and 9

Component	Material	Size/Amount	Useful Life (years)	Cost per unit (\$)
Holding Tank	Fiberglass	50 gallons	20	Included in \$599 unit cost
Holding tank shutoff valve	PVC	3/8 inch	20	25
Dispensing faucet	Stainless steel	1 ft of steel, 1mm thick	5	12
in-line activated carbon post filter	GAC	1.5 ft high, 0.5 ft diameter, 0.25 ft radius	1	34
Drain clamp	Stainless steel	3/8 inch	30	Included in unit cost
feed water saddle valve	PVC	3/8 inch	1	25
activated carbon pre-filter	GAC	1.5 ft high, 0.5 ft diameter, 0.25 ft radius	1	34

sediment removal pre-filter	Polypropylene	1.5 ft high, 0.5 ft diameter, 0.25 ft radius	1	17
RO membrane	Polysulfone	1.5 ft high, 1 ft diameter, 0.5 ft radius	3	70
Polytube tee	PVC	3/8 inch	30	Included in unit cost
piping from holding tank to RO unit	PVC	3/8 inch	30	Included in unit cost
drain piping	PVC	3/8 inch	30	Included in unit cost
inlet piping	PVC	3/8 inch	30	Included in unit cost

Table E7: Cost Components of the POE AM Device N in Region 5

Component	Material	Size	Useful Life (years)	Unit Cost (\$)
Filter media	granular ferric hydroxide	1 cu. Ft. (1.0 CF model)	5	\$650
Iron pre-filter	GAC	1.5 ft high, 0.5 ft diameter, 0.25 ft radius	1	\$40
Filter vessel	fiberglass	DIAMETER: 9" HEIGHT: 55" (1.0 CF unit)	30	\$2394
5900 system valves	PVC	1/4 inch	1	\$50
O-rings and spacers	rubber	1 inch diameter, 0.8 inner diameter	1	\$40 (replacing all o-rings and spacers)
Filter gravel	gravel	12 cu.ft.	30	Initial gravel included with POE unit

Table E8: Cost Components of the POE AM Device K in Region 5

Component	Material	Size	Useful Life (years)	Unit cost (\$)
Control Valve	reinforced thermoplastic	1" thick	4	\$150
Media tank	Quadra-Hull tank (fiberglass)	10 x 54 in	30	\$3400 (includes initial underbedding)
filter media	GFH	1.5 cu ft	3	\$815
underbedding	Gravel	15 lb.	30	Initial underbedding included in unit cost of POE device

Table E9: Cost Components of the POU RO Device G in Region 7

Component	Material	Size	Useful Life (years)	Unit Cost (\$)
Storage Tank	Fiberglass	1.7 gallons	20	Included in initial unit cost of \$500
Pre-filter (carbon)	GAC	1.5 ft high, 0.5 ft diameter, 0.25 ft radius	1	\$30
Pre-filter (sediment)	Polypropylene	1.5 ft high, 0.5 ft diameter, 0.25 ft radius	1	\$25
post-filter (carbon)	GAC	1.5 ft high, 0.5 ft diameter, 0.25 ft radius	1	\$30
Faucet	Stainless steel		5	\$12
RO membrane	Polysulfone	1.5 ft high, 1 ft diameter, 0.5 ft radius	3	\$70
inlet piping	PVC	1/4 inch	30	Included in initial unit cost
drain piping	PVC	1/4 inch	30	Included in initial unit cost
piping to tank	PVC	1/4 inch	30	Included in initial unit cost

Figure E1: Best case and worst-case cost estimates for POU/POE devices across all four regions

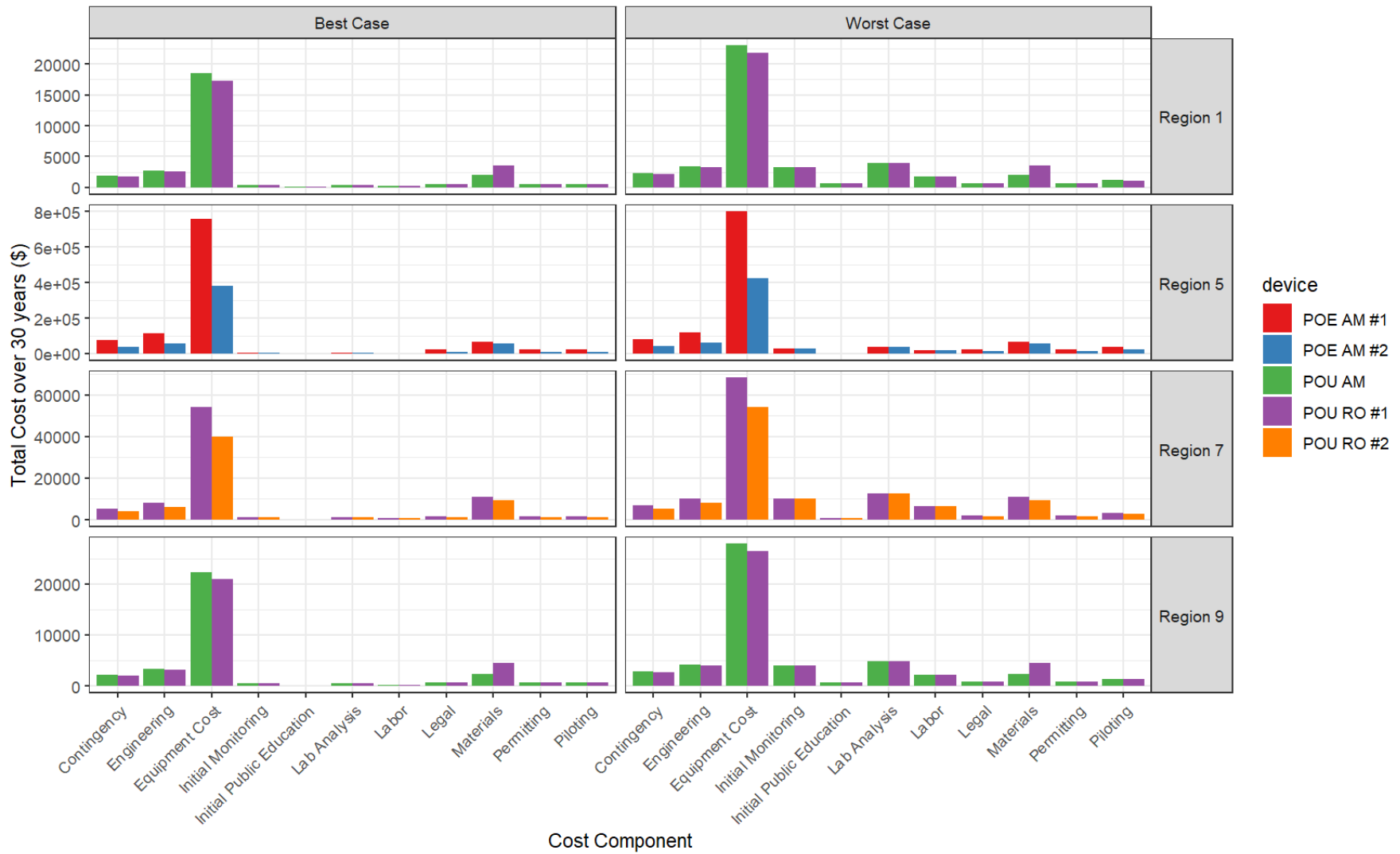

Region 5 – Centralized Upgrade

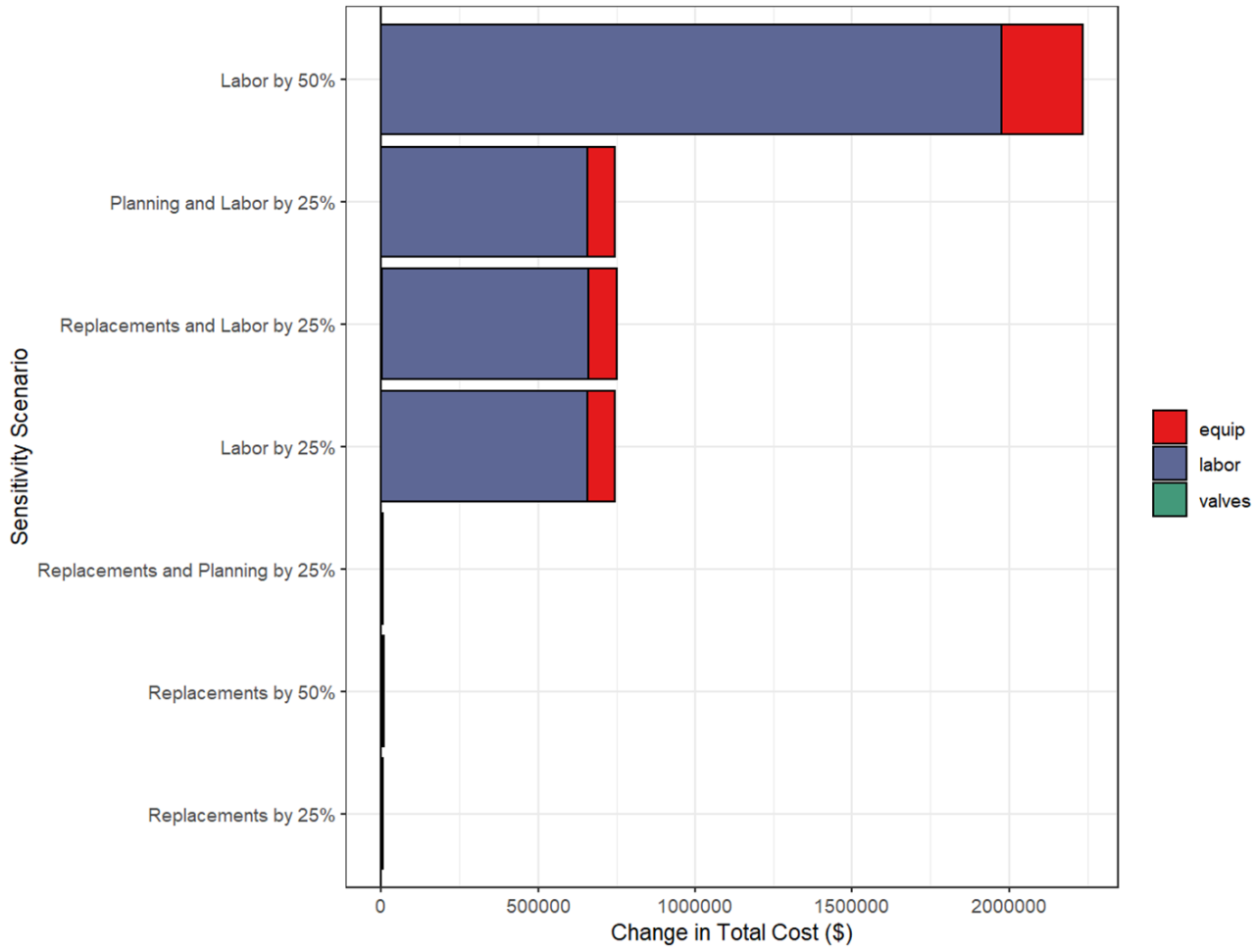

Region 5 – POE AM Device N

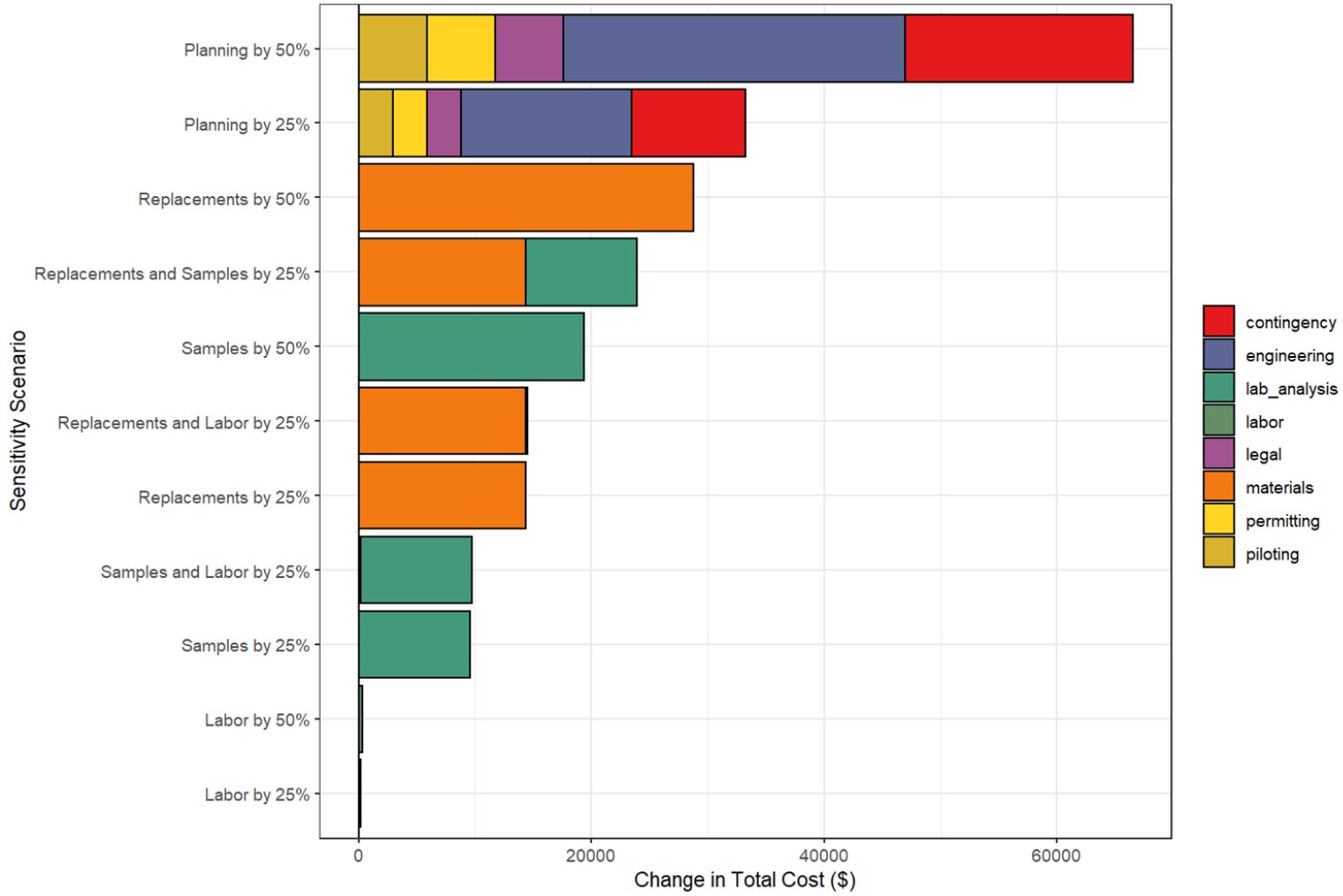

Region 5 – POE AM Device K

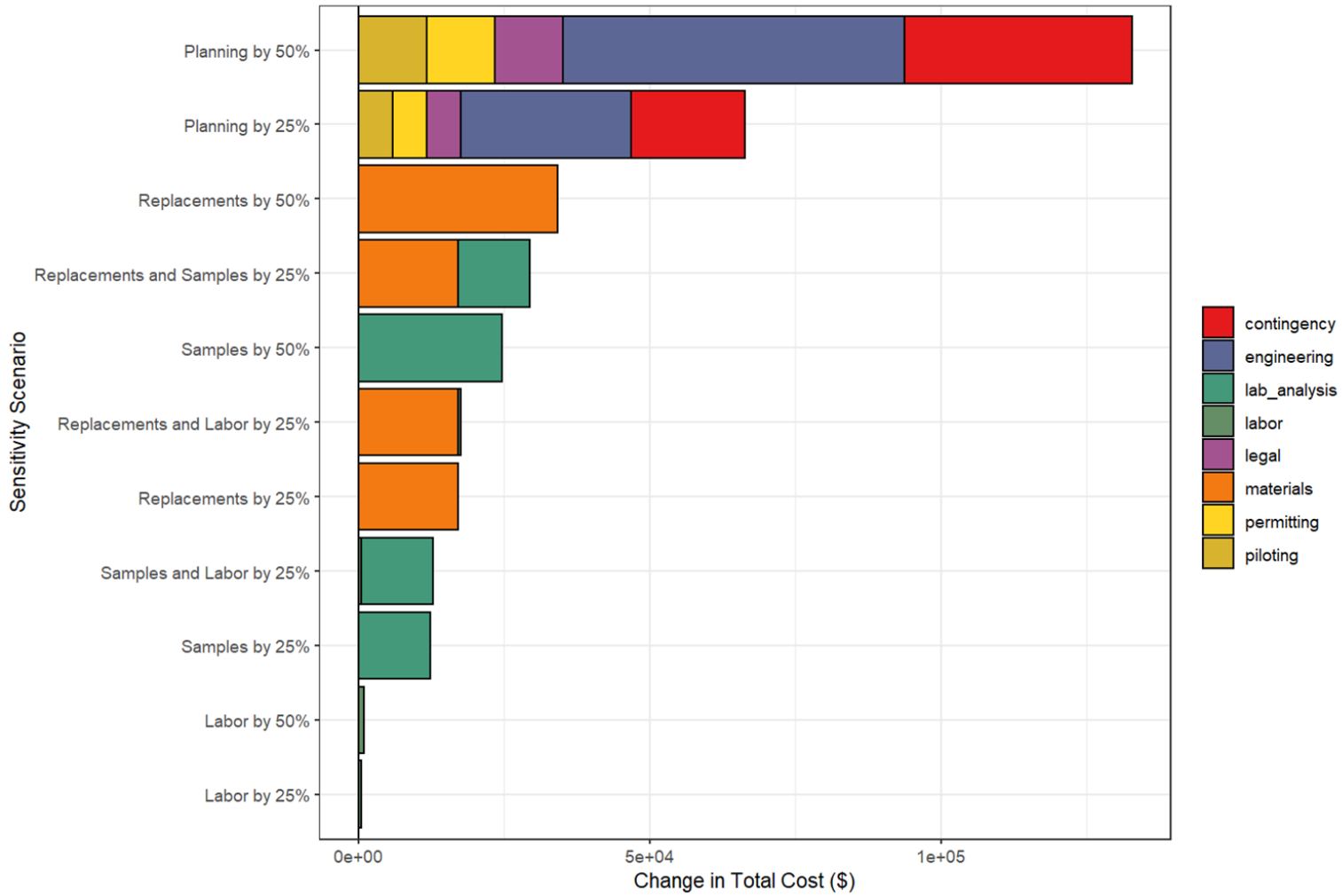

Region 7 – Centralized Upgrade

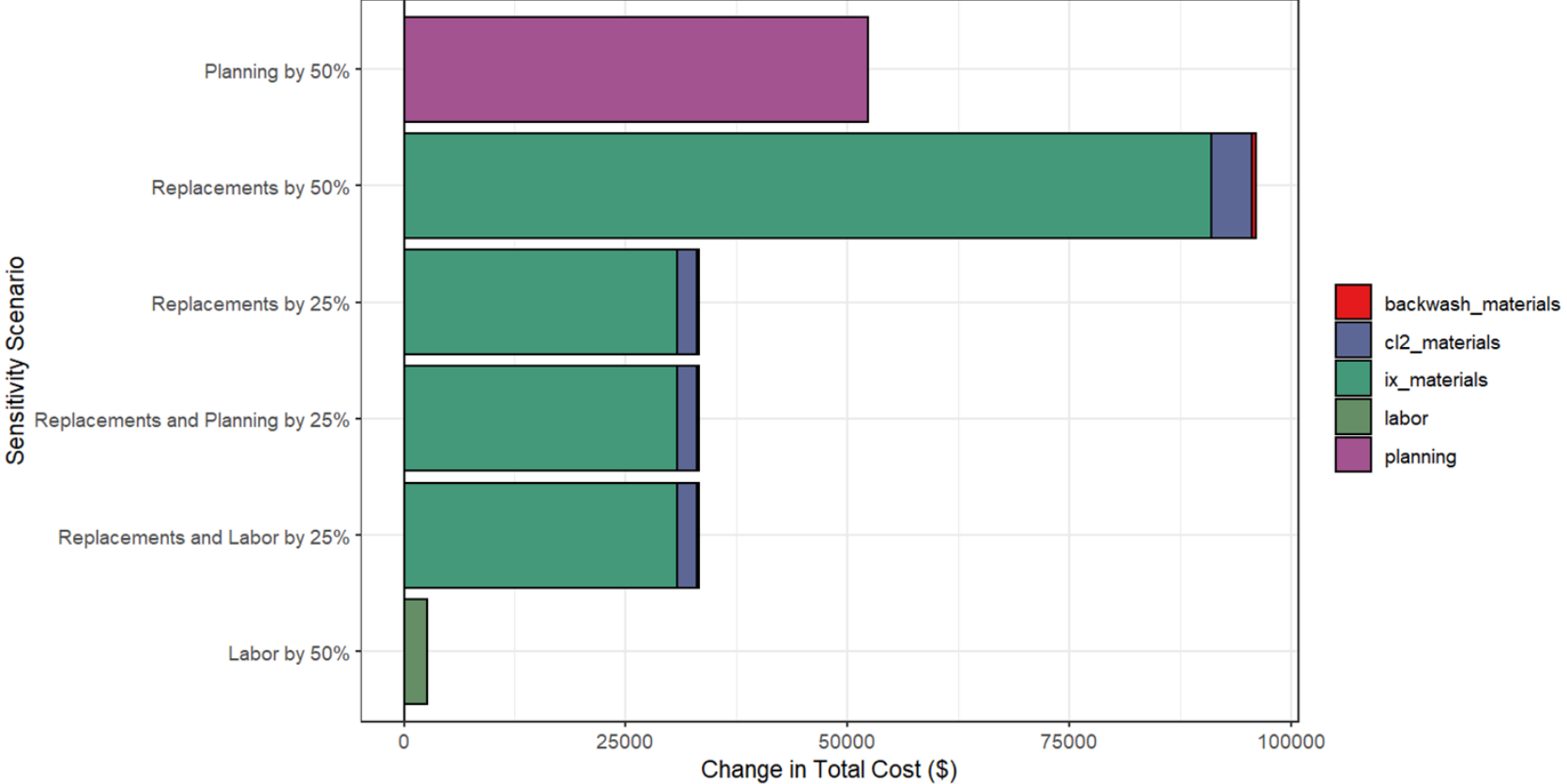

Region 7 – POU RO Device D

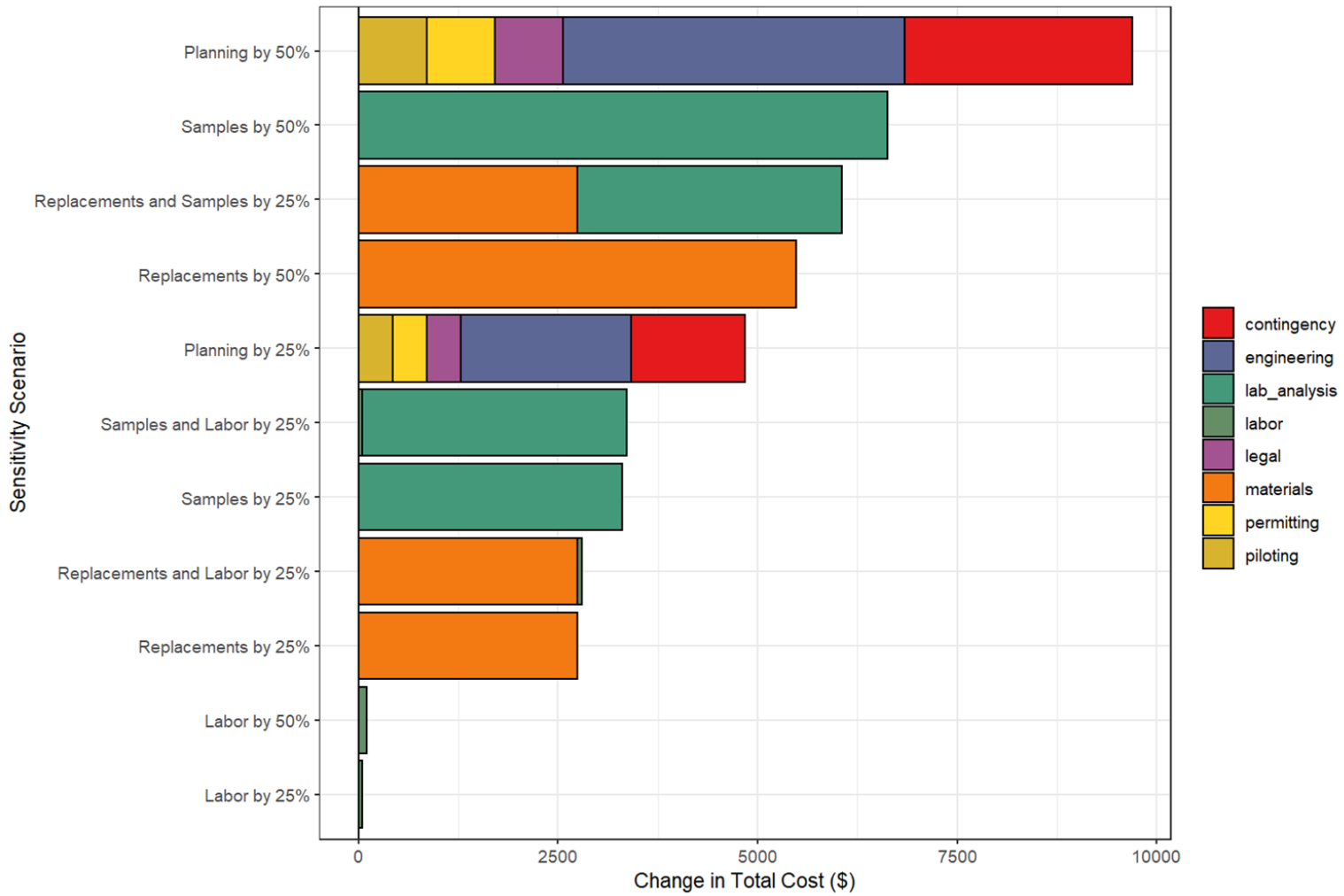

Region 7 – POU RO Device G

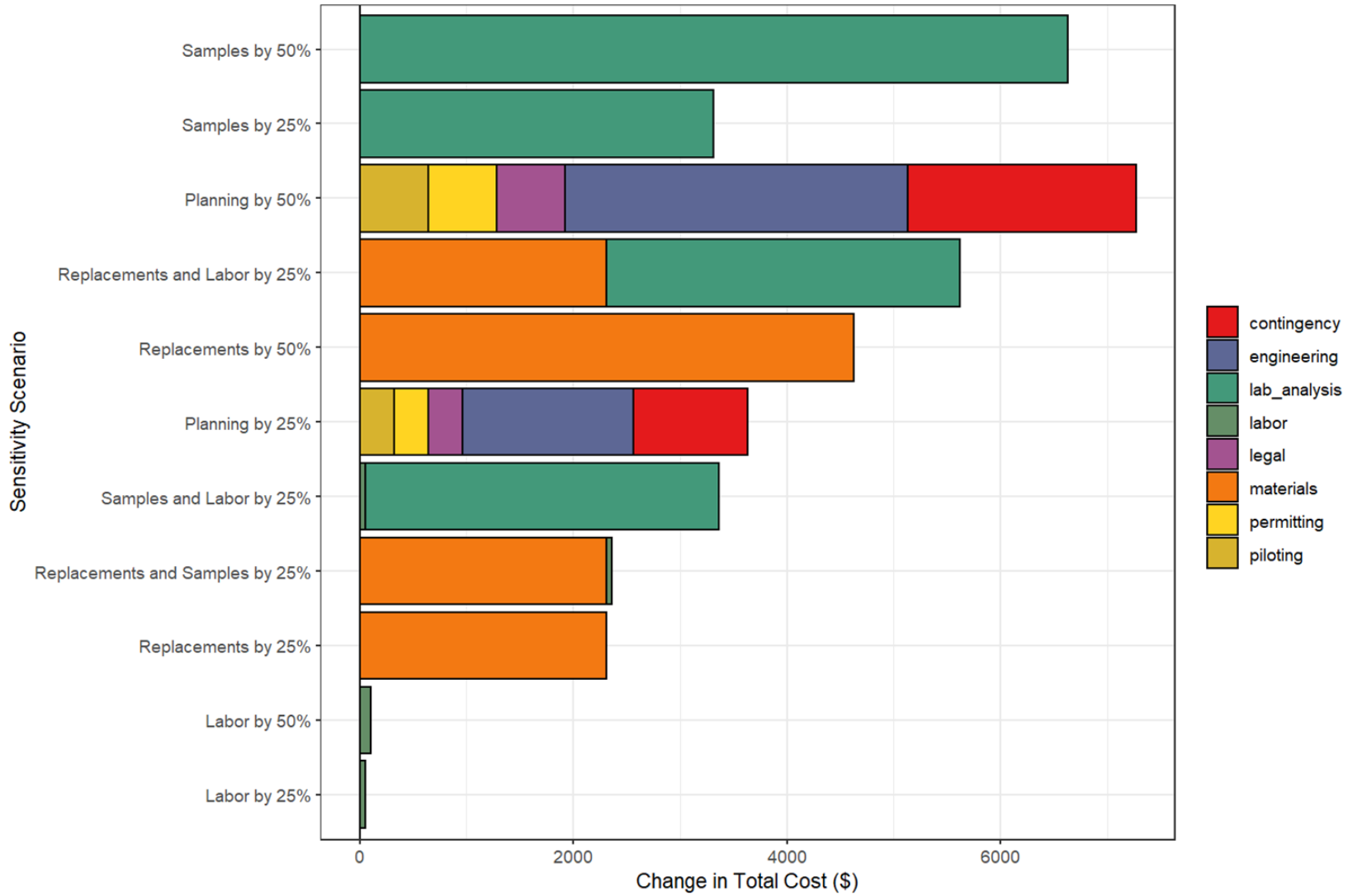

Region 9 – Centralized Upgrade

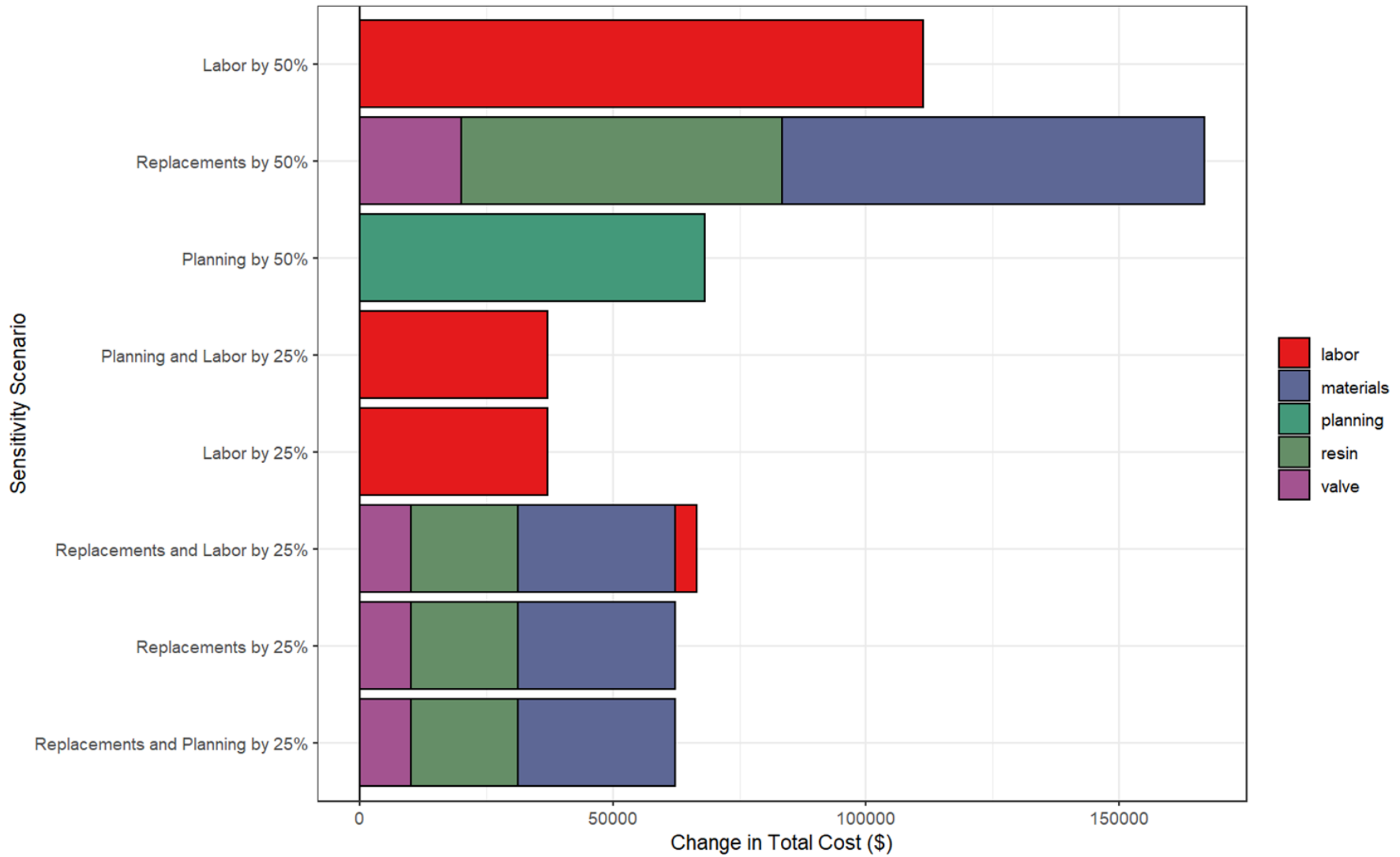

Region 9 – POU AM Device B

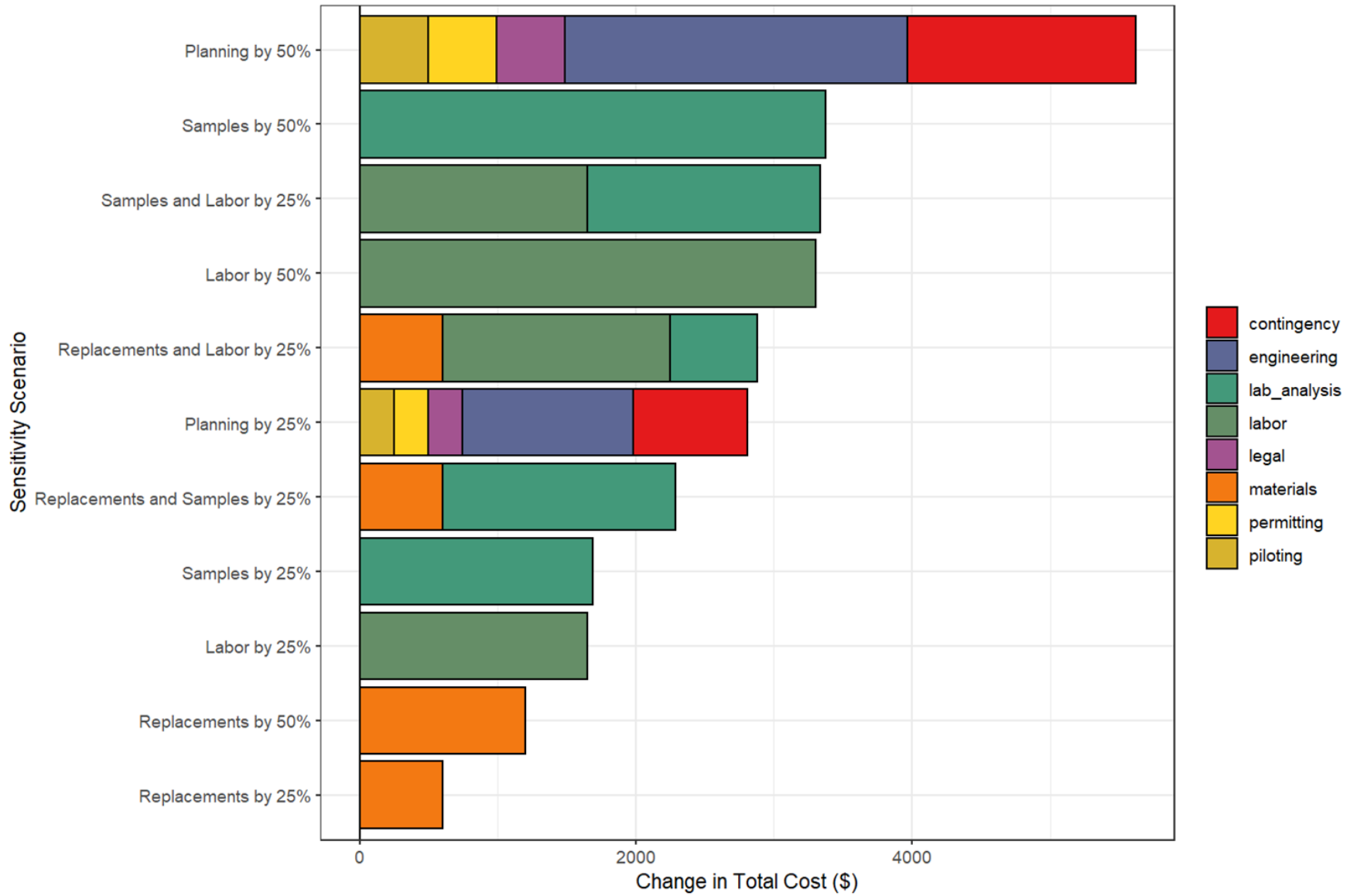

Region 9 – POU RO Device D

